

FESTO

Product overview 2022

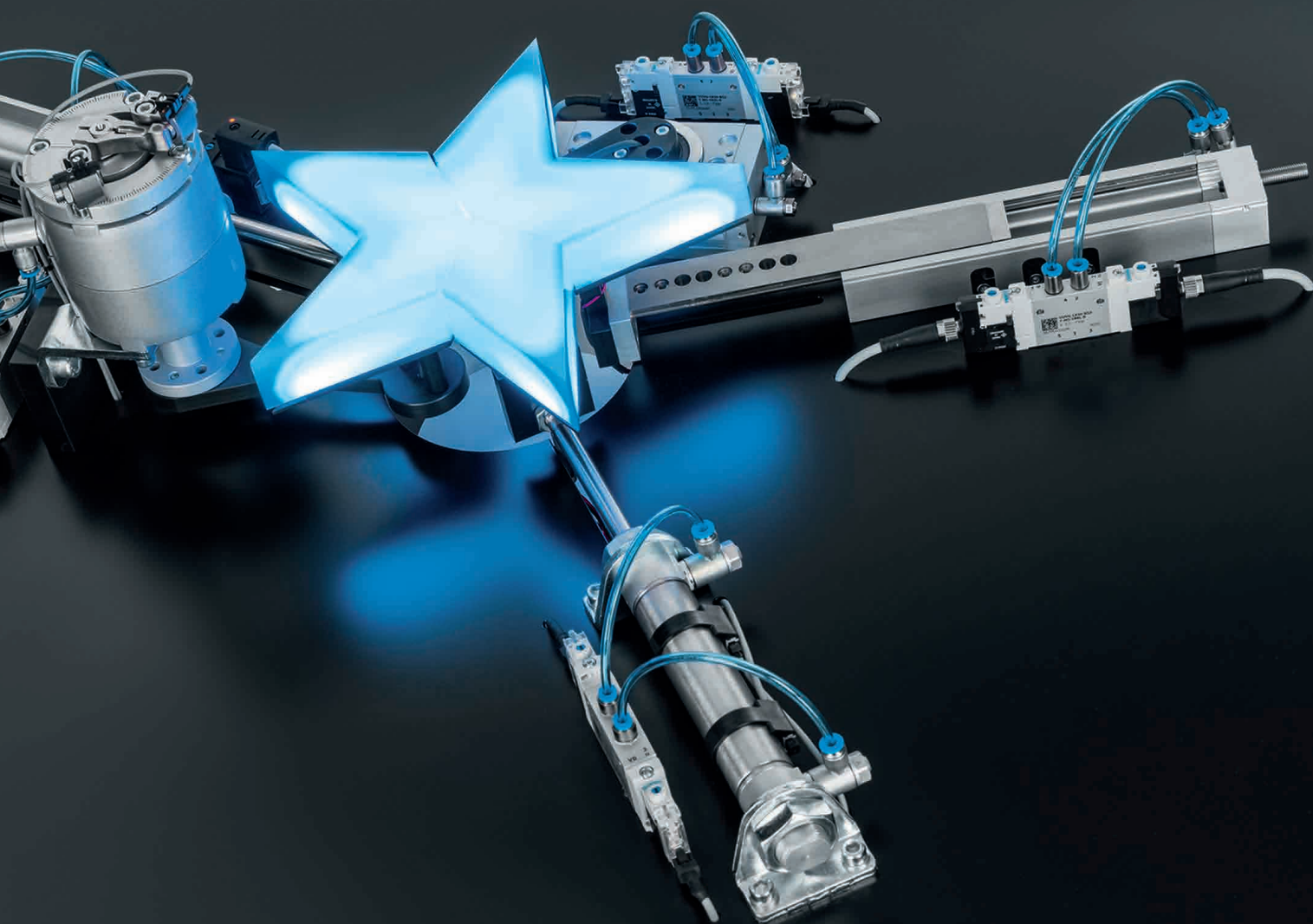



Product overview 2022

Issue 2022/07

All technical data are correct at the time of going to print.

All content, texts, representations, illustrations and drawings included in this catalogue are the intellectual property of Festo SE & Co. KG and are protected by copyright law. No part of this publication may be reproduced, processed, translated or transmitted in any form or by any means, electronic, mechanical, photocopying or otherwise, without the prior written permission of Festo SE & Co. KG.

All technical data are subject to change according to technical updates.

Festo SE & Co. KG
Postfach
73726 Esslingen
Ruiter Strasse 82
73734 Esslingen
Germany

	Editorial	3	⊙	
	Drives	Pneumatic drives	17	01
		Servo-pneumatic positioning systems	43	02
		Electric drives	49	03
	Motors and servo drives	59	04	
	Grippers	67	05	
	Handling systems	75	06	
	Vacuum technology	81	07	
	Valves and Valve terminals	Valves	87	08
		Valve terminals	123	09
	Motion Terminal	133	10	
	Sensors	137	11	
	Vision systems	155	12	
	Compressed air preparation	159	13	
	Connection technology	Electrical connection technology	179	14
		Pneumatic connection technology	199	15
	Control technology and software	215	16	
	Ready-to-install solutions	223	17	
	Function-specific systems	227	18	
	Other pneumatic devices	231	19	
	Process automation	235	20	
	LifeTech automation	253	21	
	Services	281	22	
	Appendix	287	⊙	



FESTO

FESTO

FESTO

FESTO

FESTO

FESTO
Innovative
in Automation

FESTO

FESTO



**We are pneumatic.
We are electric.
We are 30,000 technology-neutral solutions.**

**→ WE ARE THE ENGINEERS
OF PRODUCTIVITY.**

Dear Customers,

The 2022 issue of the Product Overview from Festo is full of new as well as tried-and-tested products across the entire spectrum of factory and process automation. You can find the right component or solution here for any scenario, from pneumatic drives, valves and handling systems to everything you need for electric automation.

Our product range for Controlled Pneumatics provides you with new options. Festo combines proportional valve technology with state-of-the-art sensors and intelligent control algorithms. To do this, we use an innovative modular technology system consisting of piezoelectric and electromagnetic valve actuators. By ensuring the pressure and flow are quickly and precisely controlled, significant improvements in product quality and process efficiency can be made in a wide range of applications. Thanks to information that is made available via digital interfaces, the product portfolio forms the basis for digital factories.

Our tools not only make your planning and purchasing easier, but also the commissioning, programming and operation. The Handling Guide Online, for example, lets you create your handling system in no time and order it straightaway. Simply enter a few specifications in our sizing tools to find the right design, whatever your requirements. This means you won't run the risk of creating unnecessarily oversized, energy-guzzling solutions. Our CO₂ & TCO Guide is also new. This allows you to compare our electric and pneumatic components in terms of their energy consumption and total life cycle costs so you can make the choice that best suits you.

This transparency is a top priority for us. The guide is one of many initiatives to promote sustainability. The focus is on making automation as energy-efficient and carbon-neutral as possible. That is why we are developing digital tools that support the engineering design of energy-efficient systems and create sustainable products and solutions, such as the lightweight radial gripper DHRC. Our Festo Services help you unlock potential savings in your compressed air system. Last but not least, the training and further education offer from Didactic is also geared towards imparting the knowledge needed for sustainable actions.

I hope that this product overview inspires you to find new solutions!

Kind regards,



Dr. Ansgar Kriwet
Member of the Management Board Sales of Festo SE & Co. KG

Sustainability in automation

Climate-friendly production and energy savings? Festo makes it easy for you!

Take a quantum leap in automation technology. By using suitable components from Festo in an intelligent way, you can reduce the energy consumption of your systems and thus specifically lower your production's CO₂ emissions.

The blue path to higher efficiency

Your way to zero emissions

To achieve this goal, we have chosen a comprehensive approach that is easy to use. The right engineering design, energy-efficient and production-efficient products, Energy Saving Services, and technical training and further education all contribute to improving your ecological footprint, all the way to carbon-neutral production.

Here are some examples.

CO₂ & TCO Guide

The online tool for making sustainable decisions about technology, whether you want to automate using pneumatics or electrics. It shows the total operating costs and CO₂ consumption.

→ 01 Pneumatic drives

Vacuum generator OVEM

The intelligent vacuum generator OVEM monitors the vacuum pressure, generates vacuum only when it is needed and thus reduces energy consumption by up to 60%.

→ 07 Vacuum technology

Energy efficiency modules of the MSE6 series

You can avoid unnecessary compressed air consumption. For example, by stopping the energy supply during work cycles where possible, interrupting the compressed air supply during standstill, and detecting leakages. This saves up to 20% on compressed air.

→ 13 Compressed air preparation

Digitised pneumatics with the Motion Terminal VTEM

The Motion Terminal uses specially developed Motion Apps such as Leakage diagnostics and ECO drive, which can reduce compressed air consumption by up to 70%.

→ 10 Motion Terminal

Compressed air energy efficiency audit

The compressed air energy efficiency audit certified by the German Technical Control Board (TÜV) allows you to unlock potential savings and save up to 60% on operating costs. After the analysis, our experts will recommend an action plan.

→ 22 Services

Festo Automation Experience

Combining artificial intelligence and energy efficiency: by using artificial intelligence it is possible to continuously monitor energy consumption and predict how the system status will change.

→ www.festo.com/ax

Festo Learning Experience

The learning platform Festo LX offers suitable options for exploring the topics of sustainability and energy efficiency.

→ www.festo.com/lx

Take a look: → www.festo.com/gb/en/e/solutions/sustainability-in-manufacturing-id_5159/



Partner for maximum productivity

Editorial

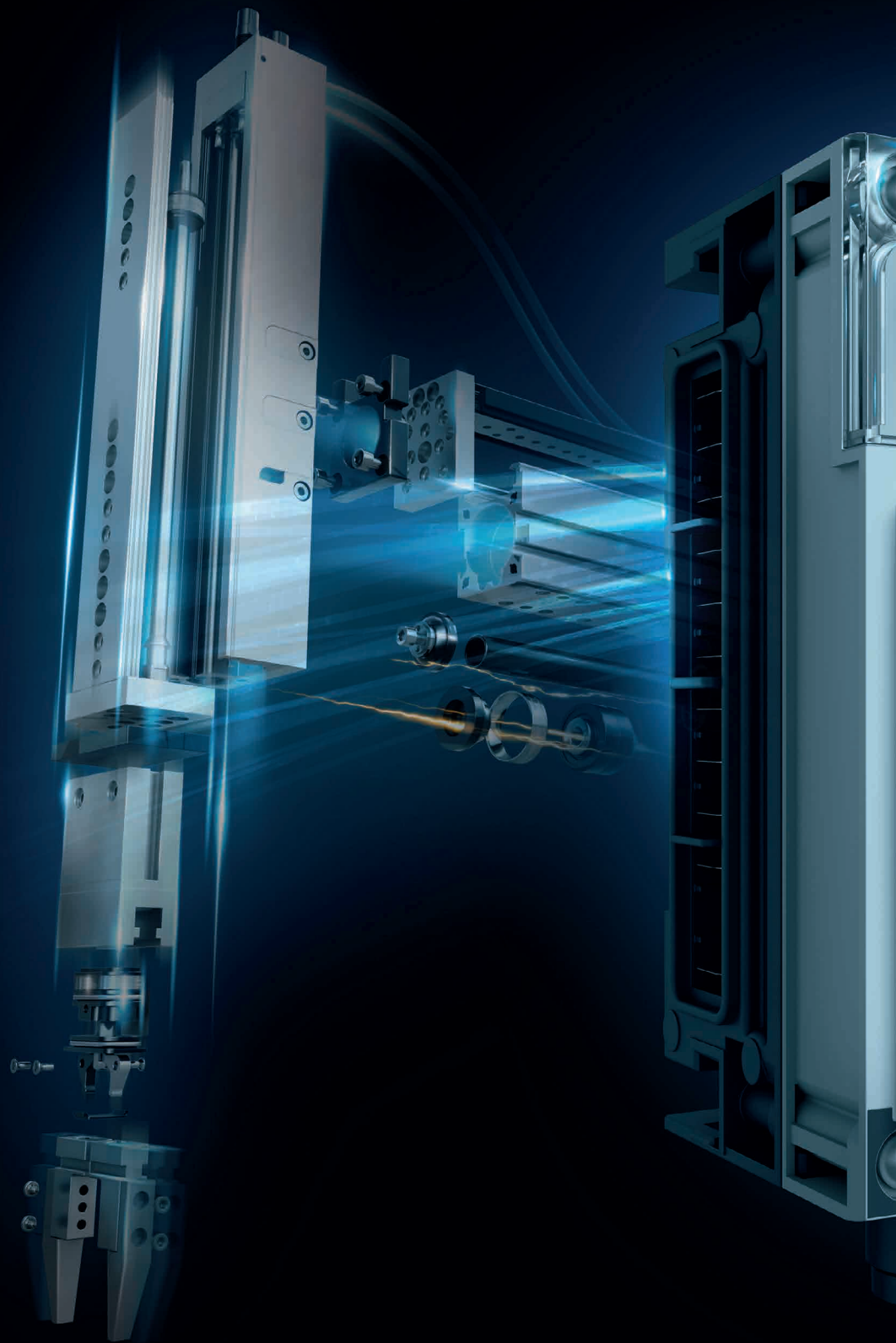

Smart. Flexible. Digital.
For your sustainable solution. for your sustainalbe solution.



Build with engineering excellence.

Use our ingredients for quick and easy engineering: extremely simple and suitable product selection, smart engineering and simulation processes, also with a digital twin, and a unique Product Key for complete product information. And procurement? It couldn't be easier.

Operate your systems smartly.

Connectivity to the cloud ensures reliable processes with greater productivity. Condition monitoring lets you see immediately when a service or repair is due – our MyDashboards will tell you. And with the Smartenance digital maintenance manager you have the servicing of all systems under control – even third-party systems.

Prepare to be inspired.

What does the automation of tomorrow look like? What are the trends? And what will make my production highly flexible, while also offering standardisation? You can find the answers right now with our Festo Motion Terminal VTEM, the first app-controlled pneumatic component. Future Concepts and our bionic studies show you how the world of tomorrow might look.

Never stop learning.

The market and global competition are accelerating steadily – and require constant learning if you want to maintain your competitive edge. You and your employees will benefit from the offer of Festo Didactic. Knowledge that pays off.

You rely on factory automation.
You rely on process automation.
We are technology and education.

→ WE ARE THE ENGINEERS
OF PRODUCTIVITY.

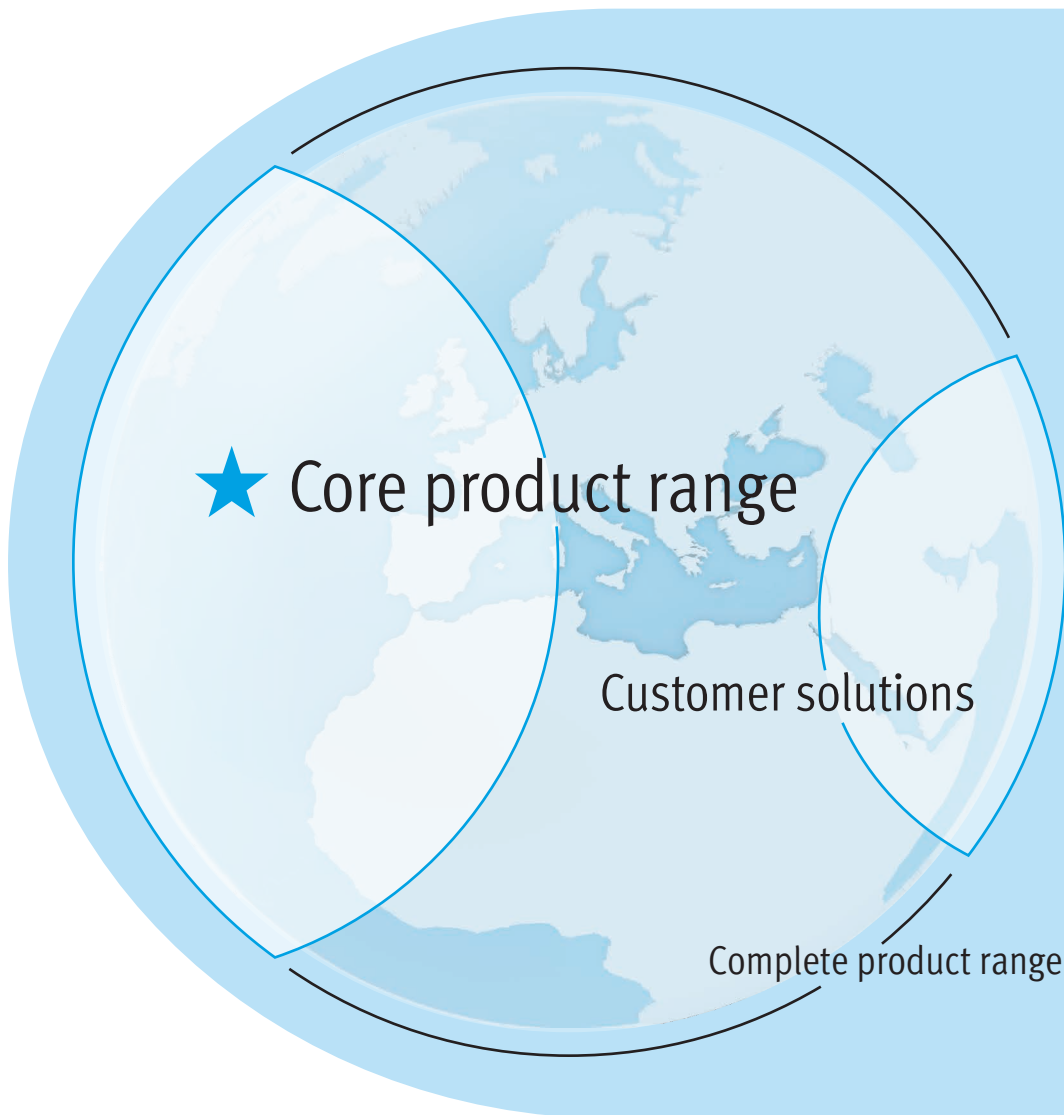

Product range

Producere – implement in advance.

Until the turn of the millennium, production was essentially still synonymous with building up a stock of an item. Now it is better described as “being prepared”, since needs, parameters and processes change rapidly and require thinking and action on several fronts at the same time.

Festo is facing these challenges too, and offers you different levels of solutions in its range.

1

Core Range

Our Core Range offers you special benefits – selected products that solve the majority of your automation tasks. They can be ordered by part number and are particularly attractively priced.



- **Quickest delivery, worldwide – wherever, whenever**
- Best value
- Easy and fast to select

Just look for the star!

2

Total product range

You will find solutions for more specific requirements in our total product range, which we will deliver on the indicated date. This part of the range is not specifically identified and also covers innovative cross-technology combinations of products right up to products that carry the seeds of digitalisation within them.

3

Customer solutions

If you cannot find the right products for your task in our range, our specialists in the Customer Solutions department are always available to provide support.

Your partner for all automation questions.
Get in touch with us at → www.festo.com

Digitalisation – megatrend for productivity

The virtual and real worlds are growing ever closer together – and are leading to Industry 4.0. Increased digitalisation is one of the basic prerequisites for this process. Festo is driving this process forward in the field of automation – and we invite our customers to undertake this journey together with us.



The future: digital products and services with added value

Digital products can do more and more and are masters at integrating additional functions. Smart components automatically optimise themselves, adapt to external influences and identify themselves. The digital twin is accessed via the Product Key. These are the prerequisites for highly flexibly and extremely fast and adaptive production.

This also includes a tailored offer in the form of intelligent, digitally networked products and services along the value creation chain. Digital configurators help you to engineer your solutions. With FluidDraw or EPLAN Schematic Solution, you get consistent, error-free documentation. Condition monitoring of components or solutions takes place via dashboards that visualise all the relevant parameters – on the go and in real time. This allows maximum system availability and optimum maintenance planning to be combined. Smartenance, the digital maintenance manager from Festo, now also features a plant logbook and data interface. It is a low-cost way of getting started with digitalisation and offers significant savings potential – including for products other than those from Festo.

Starting out in the digital world? CPX/MPA as an example

The advantages of digitalisation are clearly demonstrated by a valve terminal MPA ordered and configured in the Online Shop and the CPX automation platform with decentralised intelligence.

It is documented electromechanically and pneumatically in no time at all with Schematic Solution and FluidDraw from the App World, so that a digital twin is immediately available.

In addition, the Product Key as a data matrix code on the product ensures that important information is easy to retrieve during commissioning and maintenance.

A configurable OPC-UA interface connects the CPX/MPA to the IoT gateway that transfers the data to the Festo Cloud. Dashboards visualise this data, for example for condition monitoring. Smartenance is used for maintenance planning, including for the entire plant or production line. This combination of classic hardware and software-supported elements boosts the productivity and flexibility of the automation solution. We are happy to share this expertise with our customers.

You can find out more about digitalisation under the Festo Motion Terminal in Chapter 10 from page 133

Easy selection

The systematically faster route to the right solution



It couldn't be easier:

1. Select the product group you require from the Table of contents
→ page 1
For example: Electric drives → page 49
2. Find the products you want on the product pages using the technical features and descriptions.
3. The blue arrow directs you to the search term with which you can find all product information and process your order on the Internet. Simply add the search term or type to the Internet address.
Example with search term:
→ [www.festo.com/catalogue/spindle axis](http://www.festo.com/catalogue/spindle%20axis)
Example with type:
→ www.festo.com/catalogue/egc-bs

Are you already in the electronic product catalogue?

Enter the search term in the search field next to the magnifying glass:

★ Quick order placement for selected basic designs

We make it easy for you!

We have compiled a globally standardised core product range that not only offers you faster and easier selection, but also fast delivery.

It has been selected by Festo experts based on actual customer requirements and covers the main applications of automation technology, while offering the best possible value for money.

Products with the star: easy selection and fast delivery

You can recognise these outstanding products at a glance: they are marked in the catalogues with a ★ star.

High level of availability

In stock and generally ready for immediate dispatch: these products are available in no time at all.

More variety or individually configured? No problem!

If your requirements go beyond the main applications of automation technology or if you need individually configurable products such as valve terminals, you can choose from the full spectrum of Festo's automation portfolio with all of its technological diversity. You can find these products in our electronic catalogue online on our website and in the Online Shop.



You can benefit from these advantages whenever you need core pneumatic and electrical functions. Wherever you see this symbol in our printed or electronic catalogue, it identifies a selected product which is perfect for the main applications of automation technology. The stars will help you to find what you are looking for more quickly and place orders more easily. These star products are generally in stock and ready for immediate delivery.

At a glance:

- + Quickest delivery, worldwide – wherever, whenever
- + Best value
- + Easy and fast to select

Round-the-clock benefits



Fast and convenient

Get a quick and easy overview of prices and delivery times in the basket at any time, including shipment tracking and order documentation.

Use our Online Shop.



Request quotes

- + Quickly create quotes for your purchasing department
- + View the quote by e-mail and in your user account shortly afterwards.



Track orders

- + Planning reliability: all delivery dates in the basket at a glance
- + Track orders and view the status display, even for orders outside of the Online Shop
- + Track shipments

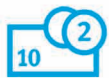

No minimum quantity surcharge for online orders

- + Reduces your costs
- + Gives you greater flexibility when ordering



Order documents and reordering

- + Easy and secure: download the order confirmation, delivery note and invoice
- + Reordering of previous orders made easy



Create warehouse labels with the Label Designer

- + Organisation and transparency in your warehouse
- + Easy identification of the stock location
- + Uniform labelling



Share and import bills of materials and baskets

- + Supports teamwork
- + Exchange data quickly with colleagues, customers, suppliers
- + Enter data only once: greater efficiency, fewer errors



Download complete documentation

- + Download all documents for the selected products with just a few clicks

You can find the Online Shop at ...

→ www.festo.com

> click on the link for “Basket”

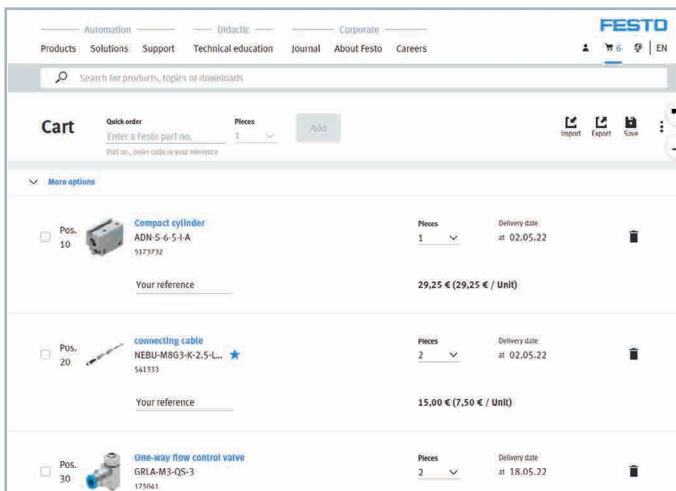

If you already have an account ...

... then you can log in directly at → www.festo.com/login or by clicking on “Login”.

If you have not yet registered ...

... you can access the registration form via → www.festo.com and click on “Register”.

Further information on the Festo Online Shop can be found here:

→ www.festo.com/ols

Festo Didactic

Festo Didactic is the world's leading supplier to technical educational institutions and provider of consulting and training services to industry. The product and service portfolio offers customers an integrated approach, covering all technological areas of factory and process automation.

We integrate technical training content with knowledge and training courses from other specialist areas like process optimisation, management and communication.

As an integral part of the Festo Group, Festo Didactic has its roots in the world of automation and industry is just part of its DNA. We work in close cooperation with Festo Automation and are familiar with the challenges faced by our customers. This enables us to offer tailored and practical training courses for industry. As well as covering our core competency in automation technology, these also include innovation topics like Industry 4.0. This content is delivered by experienced trainers and is tailored to each individual group of participants.



Selection of current training courses

Industry 4.0 Assessment –

We prepare your company for digitalisation and Industry 4.0

Like many other companies, you are probably asking yourself the following questions: how well prepared are your production and processes for the digital transformation? Where do you stand at the moment as an organisation? And how well do you prepare your employees for the digital future? Our Industry 4.0 Assessment is the ideal solution for assessing how prepared your company is for Industry 4.0 and providing a starting point for your digitalisation strategy. Together we define which Industry 4.0 technologies will add value to your company and help you to achieve your goals in the long term. Our detailed analysis offers you a reliable basis for initiating further processes and projects on the path of digital transformation.

Introduction to Industry 4.0 – Fundamentals and opportunities

Industry 4.0 is a hot topic, and one that is often understood in different ways. People working in management positions in particular are increasingly being confronted with Industry 4.0, and need to be aware of the effects. It offers companies numerous ways of enhancing productivity, quality and processes. Before it can be implemented, however, managers need a thorough understanding of all the elements and technologies, and how they are intertwined. This knowledge can then be used to develop new business models and specific strategies for implementing Industry 4.0 in the participants' own companies.

Active participation 4.0 – Interactive introduction to Industry 4.0

"Industry 4.0" is a hot topic in industry at the moment. Despite the transformation that this brings, many employees do not know what the changes will involve or why they are necessary. Changes are hard for them to understand and also cause anxiety, resulting in a lack of motivation.

The "Active participation 4.0" training course is a 1-day interactive awareness building training course for employees from industrial companies working in both production-related and non-production-related areas. Its purpose is to raise awareness of the topic of digitalisation and the changes associated with the technological transformation. The training course addresses the current challenges and motivates participants to embrace them.

Lean management and Industry 4.0 – Two solutions that complement each other

Lean management and Industry 4.0 are two concepts that pursue similar goals. With an increasing number of customised products and ever declining batch sizes, the lean concept is reaching its limits. Industry 4.0 supports the existing lean methods with new technologies. However, digitalisation produces new types of waste (particularly when it comes to data), therefore new forms of value stream analysis are becoming more important. By adapting the typical value stream analysis, these new types of waste can be identified and avoided.

Industry 4.0: Enabling the production of tomorrow

The goal of Industry 4.0 is the smart factory.

The trend in industrial production is towards the individualisation of products and batch sizes of one. Conventional processes are increasingly merging with modern information and communication technologies. The real and virtual worlds are continuing to converge, and the Internet of Things is becoming a reality.

However, the transformation and the new technical opportunities are not only affecting companies, but in particular their employees. The challenge of being able to apply the principles of self-organisation in open and unpredictable, complex and dynamic situations also calls for new knowledge on the part of your employees. New competencies – both technical, organisational or social – that were less relevant up to now are becoming increasingly important and help your employees to be productive in a new, more complex working environment.

These include the ability to reflect, analytical thinking, complex communication and coming up with new ideas.

All our services are focused on developing these necessary competencies. We always combine the transfer of knowledge with the development of skills and the practical transfer to the participants' working environment, whether in public courses, company-specific training courses or during process-oriented consultation.

The aim is to ensure that your employees not only understand the technologies around Industry 4.0, but can also apply and develop them in a targeted way in your company to help increase efficiency and performance.

You will find a small selection of our training courses on this page.

CP Factory Training – Production planning and control in the smart factory

Production planning and control (PPC) has always been one of the core tasks of a manufacturing company and is gaining in significance with smart factories and Industry 4.0 (e.g. greater product diversity, customised solutions and the demand for batch sizes of one). The purpose of production planning and control is to design the production processes so that smooth and economical operation is guaranteed. Inadequate or poor PPC frequently results in delivery, cost and quality problems. Designing an efficient PPC system is therefore essential for every manufacturing company.

Smart Maintenance – Predictive and usage-based maintenance

Cyber-physical systems enable new approaches in maintenance and yet also place higher demands on maintenance. Because all the promises of Industry 4.0, such as one-piece flow or make-to-order, can only be fulfilled with extremely high machine and system availability and reliability. Those responsible for maintenance are therefore required to use maintenance strategies that show anomalies and wear in good time before malfunctions and failures occur, and that turn maintenance into a predictable process.

Detailed information as well as course dates, locations and costs: → www.festo-didactic.com

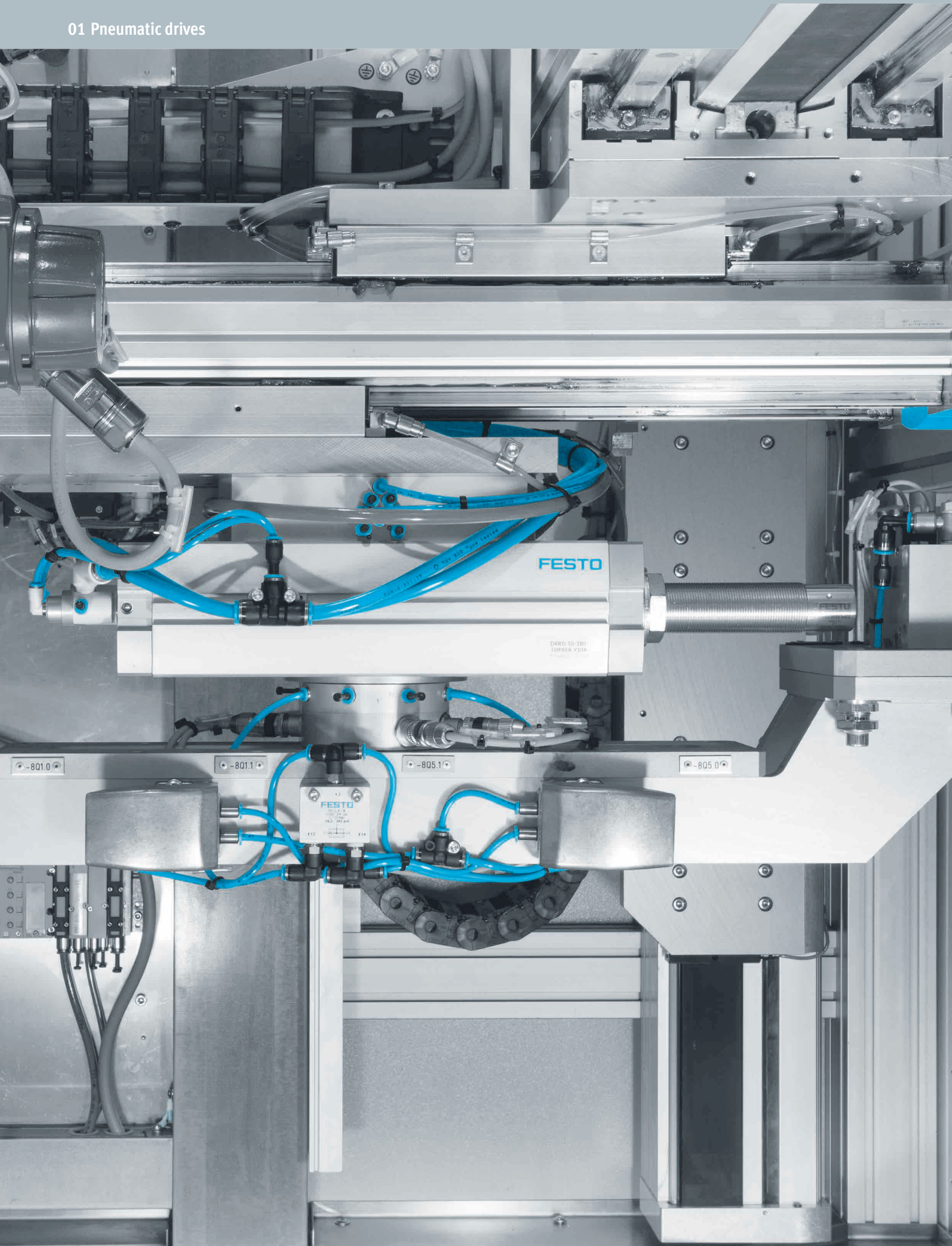

Product overview

Software tools

Pneumatic drives

Pneumatic sizing



Size pneumatic control loop systems quickly and energy-efficiently. In order to survive in a tough competitive environment, many companies are looking for ways to make savings in their production.

Such savings can often be found in their existing compressed air systems, which have generally been in place for years. Up to 60% of energy costs can be saved through optimisation at both the production facility and system level.

This tool can be found at www.festo.com/x/pneumatic-sizing

Air consumption of cylinders



Calculate your system's air consumption. Calculate your system's air consumption quickly and conveniently. Simply enter all the drives and tubing, set the cycle times and working pressure and the air consumption per minute and per day will be calculated for you. The input table including the result can be exported directly to Excel.

This tool can be found at www.festo.com/x/air-consumption

Pneumatic simulation

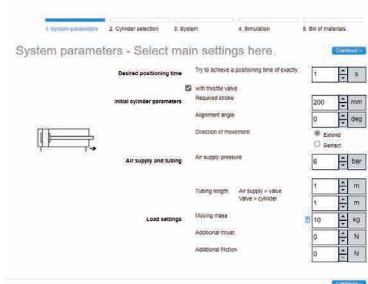

Perfect simulations replace expensive real-life tests! The tool is an expert system that supports you in the selection and configuration of the entire pneumatic control chain. If one parameter is changed, the program automatically adapts all the others.

This tool can be found at www.festo.com/x/pneumatic-simulation

Festo Design Tool 3D



The Festo Design Tool 3D is a 3D product configurator for generating specific CAD product combinations from Festo. The configurator makes your search for the right accessory easier, more reliable and faster.

You can then order the module that has been created as a single order item, either completely pre-assembled or as individual parts in a single box. This considerably reduces your bill of materials, and downstream processes such as product ordering, order picking and assembly are significantly simplified.

This tool can be found at www.festo.com/x/festo-design-tool

CO2 & TCO Guide





CO2 values and TCO for your application. Take a quantum leap in automation technology. By using suitable components from Festo in an intelligent way, you can reduce the energy consumption of your systems and thus specifically lower your production's carbon emissions.

This tool can be found at www.festo.com/x/co2-tco



Piston rod cylinder >

Round cylinders

	 Standards-based cylinder DSNU ★	 Round cylinders DSNU	 Round cylinders DSNU-S ★
Mode of operation	Double-acting	Double-acting	Double-acting
Piston diameter	8 mm, 10 mm, 12 mm, 16 mm, 20 mm, 25 mm	32 mm, 40 mm, 50 mm, 63 mm	8 mm, 12 mm, 16 mm, 20 mm, 25 mm
Theoretical force at 0.6 MPa (6 bar, 87 psi), advancing	23 ... 295 N	482.5 ... 1870.3 N	30.2 ... 294.5 N
Stroke	1 ... 500 mm	1 ... 500 mm	1 ... 200 mm
Cushioning	Elastic cushioning rings/plates at both ends, Self-adjusting pneumatic end-position cushioning, Pneumatic cushioning, adjustable at both ends	Elastic cushioning rings/plates at both ends, Self-adjusting pneumatic end-position cushioning, Pneumatic cushioning, adjustable at both ends	Elastic cushioning rings/plates at both ends, Self-adjusting pneumatic end-position cushioning
Description	<ul style="list-style-type: none"> • ISO 6432 • Wide range of variants for customised applications • Good running performance and long service life • Self-adjusting pneumatic end-position cushioning saves time during commissioning and adapts optimally to load and speed changes • Piston rod with female or male thread • For position sensing 	<ul style="list-style-type: none"> • Wide range of variants for customised applications • Good running performance and long service life • Self-adjusting pneumatic end-position cushioning saves time during commissioning and adapts optimally to load and speed changes • Piston rod with female or male thread • For position sensing 	<ul style="list-style-type: none"> • Short variant of ISO cylinder DSNU • Quick and easy installation, even in tight spaces • Light weight • Self-adjusting pneumatic end-position cushioning saves time during commissioning and adapts optimally to load and speed changes • Piston rod with male thread • For position sensing • Variants recommended for production systems for manufacturing lithium-ion batteries • Sustainable in production thanks to reduced use of materials
online: →	dsnu	dsnu	dsnu

Piston rod cylinder >





Round cylinders

	 Standards-based cylinder ESNU	 Round cylinders ESNU	 Round cylinders EG-PK
Mode of operation	Single-acting, Pushing	Single-acting, Pushing	Single-acting, Pushing
Piston diameter	8 mm, 10 mm, 12 mm, 16 mm, 20 mm, 25 mm	32 mm, 40 mm, 50 mm, 63 mm	2.5 mm, 4 mm, 6 mm
Theoretical force at 0.6 MPa (6 bar, 87 psi), advancing	19 ... 271 N	406 ... 1765 N	1.9 ... 11.8 N
Stroke	1 ... 50 mm	1 ... 50 mm	5 ... 25 mm
Cushioning	Elastic cushioning rings/plates at both ends	Elastic cushioning rings/plates at both ends	On one side, Not adjustable, No cushioning
Description	<ul style="list-style-type: none"> • ISO 6432 • Wide range of variants for customised applications • Good running performance and long service life • Piston rod with female or male thread • For position sensing 	<ul style="list-style-type: none"> • Wide range of variants for customised applications • Good running performance and long service life • Piston rod with female or male thread • For position sensing 	<ul style="list-style-type: none"> • Micro cylinder • Barbed fitting for plastic tubing with standard I.D. • Without position sensing
online: →	esnu	esnu	eg-pk

Product overview





Piston rod cylinder >

Tie rod and profile barrel cylinders

				
	Standards-based cylinders DSBC, pre-configured DSBC ★	Standards-based cylinders DSBG	Standards-based cylinders DSBG	Standards-based cylinders, Clean Design DSBF
Mode of operation	Double-acting	Double-acting	Double-acting	Double-acting
Piston diameter	32 mm, 40 mm, 50 mm, 63 mm, 80 mm, 100 mm, 125 mm	32 mm, 40 mm, 50 mm, 63 mm, 80 mm, 100 mm, 125 mm	160 mm, 200 mm, 250 mm, 320 mm	32 mm, 40 mm, 50 mm, 63 mm, 80 mm, 100 mm, 125 mm
Theoretical force at 0.6 MPa (6 bar, 87 psi), advancing	415 ... 7363 N	415 ... 7363 N	12064 ... 48255 N	415 ... 7363 N
Stroke	1 ... 2800 mm	1 ... 2800 mm	1 ... 2700 mm	1 ... 2800 mm
Cushioning	Elastic cushioning rings/plates at both ends, Self-adjusting pneumatic end-position cushioning, Pneumatic cushioning, adjustable at both ends	Elastic cushioning rings/plates at both ends, Self-adjusting pneumatic end-position cushioning, Pneumatic cushioning, adjustable at both ends	Elastic cushioning rings/plates at both ends, Pneumatic cushioning, adjustable at both ends	Elastic cushioning rings/plates at both ends, Self-adjusting pneumatic end-position cushioning, Pneumatic cushioning, adjustable at both ends
Description	<ul style="list-style-type: none"> • ISO 15552 (ISO 6431, VDMA 24562) • Self-adjusting pneumatic end-position cushioning saves time during commissioning and adapts optimally to load and speed changes • Standard profile with two sensor slots • Wide range of variants for customised applications • Comprehensive range of mounting accessories for just about every type of installation • For position sensing • Variants recommended for production systems for manufacturing lithium-ion batteries 	<ul style="list-style-type: none"> • ISO 15552 (ISO 6431, VDMA 24562) • Sturdy tie rod design • Self-adjusting pneumatic end-position cushioning saves time during commissioning and adapts optimally to load and speed changes • Comprehensive range of mounting accessories for just about every type of installation • For position sensing • Variants to EU Explosion Protection Directive (ATEX) 	<ul style="list-style-type: none"> • ISO 15552 (ISO 6431, VDMA 24562) • Sturdy tie rod design • Pneumatic end-position cushioning adjustable at both ends • Optionally without pneumatic end-position cushioning, adjustable at both ends, and position sensing, resulting in a price advantage • Optionally with spacer bolt attachment • For position sensing • Variants to EU Explosion Protection Directive (ATEX) 	<ul style="list-style-type: none"> • ISO 15552 • Increased corrosion protection • Easy-to-clean design • FDA-approved lubrication and sealing on the basic version • Long service life thanks to optional dry-running seal • Self-adjusting pneumatic end-position cushioning saves time during commissioning and adapts optimally to load and speed changes • For position sensing
online: →	dsbc	dsbg	dsbg	dsbf

Piston rod cylinder >





Compact, short-stroke and flat cylinders

	 Compact cylinders ADN ★	 Compact cylinders AEN	 Compact cylinder ADN-S ★	 Compact cylinders AEN-S
Mode of operation	Double-acting	Single-acting, Pushing, Pulling	Double-acting	Pushing
Piston diameter	12 mm, 16 mm, 20 mm, 25 mm, 32 mm, 40 mm, 50 mm, 63 mm, 80 mm, 100 mm, 125 mm	12 mm, 16 mm, 20 mm, 25 mm, 32 mm, 40 mm, 50 mm, 63 mm, 80 mm, 100 mm	6 mm, 10 mm, 12 mm, 16 mm, 20 mm, 25 mm, 32 mm, 40 mm, 50 mm, 63 mm	6 mm, 10 mm, 12 mm, 16 mm, 20 mm, 25 mm, 32 mm, 40 mm, 50 mm, 63 mm
Theoretical force at 0.6 MPa (6 bar, 87 psi), advancing	51 ... 7363 N	54 ... 4416 N	17 ... 1870 N	13 ... 1780 N
Stroke	1 ... 500 mm	1 ... 25 mm	5 ... 50 mm	5 ... 25 mm
Cushioning	Elastic cushioning rings/plates at both ends, Self-adjusting pneumatic end-position cushioning	Elastic cushioning rings/plates at both ends	Elastic cushioning rings/plates at both ends, No cushioning	Elastic cushioning rings/plates at both ends, No cushioning
Description	<ul style="list-style-type: none"> • ISO 21287 • Up to 50% less installation space than comparable standards-based cylinders to ISO 15552 • Piston rod with female or male thread • Wide range of variants for customised applications • For position sensing • Variants recommended for production systems for manufacturing lithium-ion batteries 	<ul style="list-style-type: none"> • ISO 21287 • Up to 50% less installation space than comparable standards-based cylinders to ISO 15552 • Piston rod with female or male thread • Wide range of variants for customised applications • For position sensing 	<ul style="list-style-type: none"> • Minimal installation space • Very lightweight • Ideal for small movements • Piston rod with female or male thread • For position sensing • Variants recommended for production systems for manufacturing lithium-ion batteries • Sustainable in production thanks to reduced use of materials 	<ul style="list-style-type: none"> • Minimal installation space • Very lightweight • Ideal for small movements • High forces in a compact size • Piston rod with female or male thread • For position sensing
online: →	adn	aen	adn-s	aen-s

Product overview

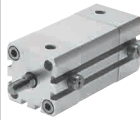

Piston rod cylinder >

Compact, short-stroke and flat cylinders

				
	Short-stroke cylinders ADVC, AEVC	Compact cylinders, multimount DPDM	Compact cylinders ADN-EL	Compact cylinders, Clean Design CDC
Mode of operation	Double-acting, Single-acting, Pushing	Double-acting, Single-acting, Pushing, Pulling	Double-acting	Double-acting
Piston diameter	4 mm, 6 mm, 10 mm, 12 mm, 16 mm, 20 mm, 25 mm, 32 mm, 40 mm, 50 mm, 63 mm, 80 mm, 100 mm	6 mm, 10 mm, 16 mm, 20 mm, 25 mm, 32 mm	20 mm, 25 mm, 32 mm, 40 mm, 50 mm, 63 mm, 80 mm, 100 mm	20 mm, 25 mm, 32 mm, 40 mm, 50 mm, 63 mm, 80 mm
Theoretical force at 0.6 MPa (6 bar, 87 psi), advancing	4.9 ... 4712 N	9 ... 483 N	188 ... 4712 N	141 ... 3016 N
Stroke	2.5 ... 25 mm	5 ... 50 mm	10 ... 500 mm	1 ... 500 mm
Cushioning	Elastic cushioning rings/plates at both ends	Elastic cushioning rings/plates at both ends	Elastic cushioning rings/plates at both ends	Elastic cushioning rings/plates at both ends
Description	<ul style="list-style-type: none"> • Very short overall length • High forces in a compact size • Piston rod with female or male thread • Optimised fitting space and height • Mounting hole pattern to VDMA 24562 as of Ø 32 mm • For position sensing with proximity sensor for T-slot and for C-slot 	<ul style="list-style-type: none"> • Mounting using through-hole and female thread • Compact design • Piston rod variants • For position sensing • Sustainable in production thanks to reduced use of materials 	<ul style="list-style-type: none"> • ISO 21287 • With end-position locking at both ends, front or rear • Piston rod with female or male thread • For position sensing 	<ul style="list-style-type: none"> • ISO 21287 • Up to 50% less installation space than comparable standards-based cylinders to ISO 15552 • Easy-to-clean design • Increased corrosion protection • Wide range of variants for customised applications • Piston rod with female or male thread • For position sensing
online: →	advc	dpdm	adn-el	cdc



Piston rod cylinder >

Compact, short-stroke and flat cylinders

			
	Flat cylinders DZF	Flat cylinders DZH	Flat cylinders EZH
Mode of operation	Double-acting	Double-acting	Single-acting, Pushing
Piston diameter	Equivalent diameter, 12 mm, 18 mm, 25 mm, 32 mm, 40 mm, 50 mm, 63 mm	Equivalent diameter, 16 mm, 20 mm, 25 mm, 32 mm, 40 mm, 50 mm, 63 mm	Equivalent diameter, 3 mm, 6 mm, 12 mm, 22 mm
Theoretical force at 0.6 MPa (6 bar, 87 psi), advancing	51 ... 1870 N	104 ... 1870 N	3.8 ... 205 N
Stroke	1 ... 320 mm	1 ... 1000 mm	10 ... 50 mm
Cushioning	Elastic cushioning rings/plates at both ends	Pneumatic cushioning, adjustable at both ends	No cushioning
Description	<ul style="list-style-type: none"> • Extremely flat design • Protected against rotation thanks to special piston shape • Ideal for manifold assembly • Wide variety of mounting and attachment options • Piston rod with female or male thread • For position sensing 	<ul style="list-style-type: none"> • Flat design • Protected against rotation thanks to special piston shape • Ideal for manifold assembly • Wide variety of mounting and attachment options • Piston rod with male thread • For position sensing 	<ul style="list-style-type: none"> • Extremely flat design • Protected against rotation thanks to special piston shape • Wide variety of mounting and attachment options • For position sensing
online: →	dzf	dzh	ezh



Piston rod cylinder >

Multimount and cartridge cylinders

	 Compact cylinders, multimount DPDM	 Cartridge cylinders EGZ
Mode of operation	Double-acting, Single-acting, Pushing, Pulling	Single-acting, Pushing
Piston diameter	6 mm, 10 mm, 16 mm, 20 mm, 25 mm, 32 mm	6 mm, 10 mm, 16 mm
Theoretical force at 0.6 MPa (6 bar, 87 psi), advancing	9 ... 483 N	13.9 ... 109 N
Stroke	5 ... 50 mm	5 ... 15 mm
Cushioning	Elastic cushioning rings/plates at both ends	No cushioning
Description	<ul style="list-style-type: none"> • Mounting using through-hole and female thread • Compact design • Piston rod variants • For position sensing • Sustainable in production thanks to reduced use of materials 	<ul style="list-style-type: none"> • Minimal installation space • Installation with or without mounting components • Piston rod with male thread
online: →	dpdm	egz

Piston rod cylinder >



Cylinders with clamping unit

	 Standards-based cylinders with clamping unit DSBC-C	 Round cylinders with clamping unit DSNU-KP	 Round cylinders with clamping unit DSNU-KP
Mode of operation	Double-acting	Double-acting	Double-acting
Piston diameter	32 mm, 40 mm, 50 mm, 63 mm, 80 mm, 100 mm, 125 mm	8 mm, 10 mm, 12 mm, 16 mm, 20 mm, 25 mm	32 mm, 40 mm, 50 mm, 63 mm
Theoretical force at 0.6 MPa (6 bar, 87 psi), advancing	415 ... 7363 N	23 ... 295 N	483 ... 1870 N
Stroke	1 ... 2800 mm	1 ... 500 mm	1 ... 500 mm
Cushioning	Elastic cushioning rings/plates at both ends, Self-adjusting pneumatic end-position cushioning, Pneumatic cushioning, adjustable at both ends	Elastic cushioning rings/plates at both ends, Self-adjusting pneumatic end-position cushioning, Pneumatic cushioning, adjustable at both ends	Elastic cushioning rings/plates at both ends, Self-adjusting pneumatic end-position cushioning, Pneumatic cushioning, adjustable at both ends
Performance level (PL)			
Description	<ul style="list-style-type: none"> • The piston rod can be held in any position • Piston rod can be held in position for long periods even with alternating loads, fluctuating operating pressure or leaks in the system • Mounting hole pattern to ISO 15552 • Piston rod with female or male thread • For position sensing 	<ul style="list-style-type: none"> • Based on ISO 6432 • The piston rod can be held in any position • The piston rod can also be held for long periods with alternating loads, fluctuating operation pressure or loss of pressure • For position sensing 	<ul style="list-style-type: none"> • The piston rod can be held in any position • The piston rod can also be held for long periods with alternating loads, fluctuating operation pressure or loss of pressure • For position sensing
online: →	dsbc-c	dsnu-kp	dsnu-kp

Product overview





Piston rod cylinder >

Cylinders with clamping unit

	 Compact cylinders with clamping unit ADN-KP	 Cylinders with holding brake DFCL	 Cylinders with holding brake DFLG
Mode of operation	Double-acting	Double-acting	Double-acting
Piston diameter	20 mm, 25 mm, 32 mm, 40 mm, 50 mm, 63 mm, 80 mm, 100 mm	40 mm, 63 mm, 100 mm	160 mm
Theoretical force at 0.6 MPa (6 bar, 87 psi), advancing	188 ... 4712 N	754 ... 4712 N	12064 N
Stroke	10 ... 500 mm	10 ... 2000 mm	10 ... 2000 mm
Cushioning	Elastic cushioning rings/plates at both ends	Pneumatic cushioning, adjustable at both ends	Pneumatic cushioning, adjustable at both ends
Performance level (PL)		Stopping, holding, blocking a movement/ category 1, Performance Level c	Stopping, holding, blocking a movement/ category 1, Performance Level c
Description	<ul style="list-style-type: none"> The piston rod can be held in any position The piston rod can also be held for long periods with alternating loads, fluctuating operation pressure or loss of pressure Mounting hole pattern to ISO 21287 Piston rod with female or male thread For position sensing 	<ul style="list-style-type: none"> Combination of holding brake and standards-based cylinder based on ISO 15552 Holding function: retains the piston rod by clamping with frictional locking Emergency braking function: stops the movement of the piston rod by clamping with frictional locking With safety functions Variants to EU Explosion Protection Directive (ATEX) Optional: high level of corrosion protection For position sensing 	<ul style="list-style-type: none"> Combination of holding brake and standards-based cylinder based on ISO 15552 Holding function: retains the piston rod by clamping with frictional locking Emergency braking function: stops the movement of the piston rod by clamping with frictional locking With safety functions Variants to EU Explosion Protection Directive (ATEX) Optional: high level of corrosion protection For position sensing
online: →	adn-kp	dfcl	dflg

Piston rod cylinder >



Stainless steel cylinders

				
	Standards-based cylinder CRDSNU, CRDSNU-B	Round cylinders CRDSNU, CRDSNU-B	Standards-based cylinders CRDNG, CRDNGS	Round cylinders CRHD
Mode of operation	Double-acting	Double-acting	Double-acting	Double-acting
Piston diameter	12 mm, 16 mm, 20 mm, 25 mm	32 mm, 40 mm, 50 mm, 63 mm, 80 mm, 100 mm	32 mm, 40 mm, 50 mm, 63 mm, 80 mm, 100 mm, 125 mm	32 mm, 40 mm, 50 mm, 63 mm, 80 mm, 100 mm
Theoretical force at 0.6 MPa (6 bar, 87 psi), advancing	68 ... 295 N	483 ... 4712 N	483 ... 7363 N	483 ... 4712 N
Stroke	1 ... 500 mm	1 ... 500 mm	10 ... 2000 mm	10 ... 500 mm
Cushioning	Elastic cushioning rings/plates at both ends, Self-adjusting pneumatic end-position cushioning, Pneumatic cushioning, adjustable at both ends	Elastic cushioning rings/plates at both ends, Self-adjusting pneumatic end-position cushioning, Pneumatic cushioning, adjustable at both ends	Pneumatic cushioning, adjustable at both ends	Pneumatic cushioning, adjustable at both ends
Description	<ul style="list-style-type: none"> • ISO 6432 • Corrosion resistant against aggressive ambient conditions • Easy-to-clean design • Long service life thanks to optional dry-running seal • Wide range of variants for customised applications • Self-adjusting pneumatic end-position cushioning saves time during commissioning and adapts optimally to load and speed changes • For position sensing 	<ul style="list-style-type: none"> • Corrosion resistant against aggressive ambient conditions • Easy-to-clean design • Long service life thanks to optional dry-running seal • Wide range of variants for customised applications • Self-adjusting pneumatic end-position cushioning saves time during commissioning and adapts optimally to load and speed changes • For position sensing 	<ul style="list-style-type: none"> • ISO 15552 (ISO 6431, VDMA 24562) • Corrosion resistant against aggressive ambient conditions • Easy-to-clean design • Variants: through piston rod, heat-resistant design • Threaded mounting, mounting via accessories • For position sensing 	<ul style="list-style-type: none"> • Corrosion resistant against aggressive ambient conditions • Easy-to-clean design, optimised for very exacting demands • Flexible design thanks to different end caps • Piston rod with male thread • For position sensing
online: →	crdsu	crdsu	crdng	crhd

Product overview



Rodless cylinders >

Mechanically coupled cylinders

			
	Linear drives DLGF	Linear drives DGC-K	Linear drives DGC-G, DGC-GF, DGC-KF
Piston diameter	20 mm, 25 mm, 32 mm, 40 mm	18 mm, 25 mm, 32 mm, 40 mm, 50 mm, 63 mm, 80 mm	8 mm, 12 mm, 18 mm, 25 mm, 32 mm, 40 mm, 50 mm, 63 mm
Theoretical force at 0.6 MPa (6 bar, 87 psi), advancing	188 ... 754 N	153 ... 3016 N	30 ... 1870 N
Stroke	50 ... 1000 mm	1 ... 8500 mm	1 ... 8500 mm
Cushioning	Self-adjusting pneumatic end-position cushioning	Pneumatic cushioning, adjustable at both ends	Elastic cushioning rings/plates at both ends, Pneumatic cushioning, adjustable at both ends, Shock absorber, hard characteristic curve, Shock absorber, soft characteristic curve
Position sensing	Via proximity switch	Via proximity switch	Via proximity switch
Description	<ul style="list-style-type: none"> Extremely flat design Choice of two types of cushioning: self-adjusting pneumatic end-position cushioning or external hydraulic shock absorbers Supply port on the left or right or at both ends or alternatively from below Loads and devices can be directly mounted on the slide Basic design DLGF-G without external guide for simple drive functions in small installation spaces Recirculating ball bearing guide DLGF-KF with a standard recirculating ball bearing guide for high torques and heavy loads 	<ul style="list-style-type: none"> Compact design: 30% smaller than basic design DGC-G Basic drive without guide, for simple drive functions Low moving dead weight Symmetrical design 	<ul style="list-style-type: none"> All settings accessible from one side Available with variable end stops and intermediate position module Optional: NSF-H1 lubricant for the food zone (see www.festo.com/certificates/DGC) Optional: clamping unit for holding loads Sustainable operation thanks to leakage reduction at sealing points
online: →	dlgf	dgc-k	dgc

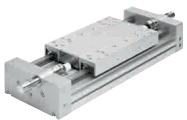

Rodless cylinders >

Mechanically coupled cylinders

		
	Linear drives with heavy-duty guide DGC-HD	Linear drives SLG
Piston diameter	18 mm, 25 mm, 40 mm	8 mm, 12 mm, 18 mm
Theoretical force at 0.6 MPa (6 bar, 87 psi), advancing	153 ... 754 N	30 ... 153 N
Stroke	1 ... 5000 mm	100 ... 900 mm
Cushioning	Shock absorber, hard characteristic curve, Shock absorber, soft characteristic curve	Elastic cushioning rings/plates at both ends, Shock absorber, hard characteristic curve
Position sensing	Via proximity switch	Via proximity switch
Description	<ul style="list-style-type: none"> For maximum loads and torques thanks to duo guide rail Very good operating performance under torque load Long service life Ideal as a basic axis for linear gantries and cantilever axes Wide range of adaptation options on the drives 	<ul style="list-style-type: none"> Extremely flat design Highest precision thanks to integrated recirculating ball bearing guide Adjustable end stops Wide range of supply ports Available with intermediate position module
online: →	dgc-hd	slg

Rodless cylinders >

Magnetically coupled cylinders

	 Linear drives DGO	 Linear drive units SLM
Piston diameter	12 mm, 16 mm, 20 mm, 25 mm, 32 mm, 40 mm	12 mm, 16 mm, 20 mm, 25 mm, 32 mm, 40 mm
Theoretical force at 0.6 MPa (6 bar, 87 psi), advancing	68 ... 754 N	68 ... 754 N
Stroke	10 ... 4000 mm	10 ... 1500 mm
Cushioning	Elastic cushioning rings/plates at both ends, Pneumatic cushioning, adjustable at both ends	Elastic cushioning rings/plates at both ends, Shock absorber, hard characteristic curve
Position sensing	Via proximity switch	Via proximity switch, Via inductive sensors
Description	<ul style="list-style-type: none"> • Magnetic power transmission • Pressure-tight and zero leakage • Dirt-proof and dust-proof • Sustainable operation thanks to leakage reduction at sealing points 	<ul style="list-style-type: none"> • Magnetic power transmission • Recirculating ball bearing guide: combination of slide unit and rodless linear drive • Individual choice of end-position cushioning and sensing
online: →	dgo	slm

Software tools

Mass moment of inertia





Juggling pencils and pocket calculators is now a thing of the past. No matter whether you have discs, blocks, push-on flanges, grippers, etc., this tool does the job of calculating all the mass moments of inertia. Just save, send or print and you're finished.

This tool can be found at
[→ www.festo.com/x/mass-moment-of-inertia](http://www.festo.com/x/mass-moment-of-inertia)

Product overview

Semi-rotary drives >

Semi-rotary drives with rotary vane

	 Semi-rotary drives DRVS ★	 Semi-rotary drives DSM	 Semi-rotary drives DSM-B, DSM-HD-B
Size	6, 8, 12, 16, 25, 32, 40	6, 8, 10	12, 16, 25, 32, 40, 63
Theoretical torque at 0.6 MPa (6 bar, 87 psi)	0.15 ... 20 Nm	0.15 ... 1.7 Nm	1.25 ... 80 Nm
Permissible mass moment of inertia	6.5 ... 350 kgcm ²	6.5 ... 26 kgcm ²	50 ... 5000 kgcm ²
Position sensing	Via proximity switch	Via proximity switch, Without	Via proximity switch
Swivel angle	0 ... 270 deg	0 ... 240 deg	0 ... 270 deg
Description	<ul style="list-style-type: none"> • Double-acting semi-rotary drive with rotary vane • Lighter than other semi-rotary drives • Fixed swivel angle, adjustable swivel angle possible with the help of accessories • Housing protected against splash water and dust • Sustainable in production thanks to reduced use of materials 	<ul style="list-style-type: none"> • Double-acting semi-rotary drive with rotary vane or with tandem rotary vane • Fixed or infinitely adjustable swivel angle • With spigot shaft or hollow flange shaft • With elastic cushioning rings/plates at both ends 	<ul style="list-style-type: none"> • Double-acting semi-rotary drive with rotary vane, with tandem rotary vane or with heavy-duty bearing • Swivel angle is infinitely adjustable over the entire swivel range • With elastic cushioning rings/plates at both ends, adjustable or with shock absorbers at both ends, self-adjusting
online: →	drvs	dsm	dsm

Semi-rotary drives >

Semi-rotary drives with rack and pinion

	 Semi-rotary drives DRRD ★
Size	8, 10, 12, 16, 20, 25, 32, 35, 40, 50, 63
Theoretical torque at 0.6 MPa (6 bar, 87 psi)	0.2 ... 112 Nm
Permissible mass moment of inertia	15 ... 420000 kgcm ²
Position sensing	Via proximity switch
Swivel angle	180 deg
Description	<ul style="list-style-type: none"> • Twin-piston drive, power transmission via rack and pinion principle • Extremely accurate in the end positions • Very high load bearing capacity • Very good axial run-out at the flanged shaft • Greater stability even with smaller sizes • Sustainable in production thanks to reduced use of materials
online: →	drrd

Semi-rotary drives >

Swivel/linear drive units



Swivel/linear units
DSL-B

Piston diameter	16 mm, 20 mm, 25 mm, 32 mm, 40 mm
Theoretical torque at 0.6 MPa (6 bar, 87 psi)	1.25 ... 20 Nm
Permissible mass moment of inertia	0.35 ... 40 kgcm ²
Position sensing	Via proximity switch
Swivel angle	0 ... 272 deg
Description	<ul style="list-style-type: none"> • Rotary and linear motion can be controlled individually or simultaneously • High repetition accuracy • With plain or recirculating ball bearing guide • Through piston rod
online: →	dsl

Tandem, high-force and multi-position cylinders >

Tandem and high-force cylinders



High-force cylinders
ADNH



Tandem cylinders
DNCT

Piston diameter	25 mm, 40 mm, 63 mm, 100 mm	32 mm, 40 mm, 50 mm, 63 mm, 80 mm, 100 mm, 125 mm
Theoretical force at 0.6 MPa (6 bar, 87 psi), advancing	1036 ... 18281 N	898 ... 14244 N
Stroke	5 ... 150 mm	2 ... 500 mm
Description	<ul style="list-style-type: none"> • Max. 4 cylinders can be combined • Increased thrust force • Only 2 connections are required to pressurise all cylinders • Piston rod with female or male thread • For position sensing • Mounting hole pattern to ISO 21287 	<ul style="list-style-type: none"> • Max. 2 cylinders can be combined • Thrust and return force increase • Piston rod with male thread • For position sensing • Mounting hole pattern to ISO 15552
online: →	adnh	dnct

Product overview



Tandem, high-force and multi-position cylinders >

Multi-position cylinders

	 <p>Multi-position cylinders ADNM</p>
Piston diameter	25 mm, 40 mm, 63 mm, 100 mm
Theoretical force at 0.6 MPa (6 bar, 87 psi), advancing	295 ... 4712 N
Max. total of all individual strokes	1000 mm, 2000 mm
Description	<ul style="list-style-type: none"> • Mounting hole pattern to ISO 21287 • Piston rod with female or male thread • 2 ... 5 cylinders can be combined • Max. 5 positions can be approached • For position sensing
online: →	adnm

Drives with guides >

Drives with slides

	 <p>Mini slides DGST</p>	 <p>Mini slides DGSL</p>	 <p>Mini slides DGSC</p>
Piston diameter	6 mm, 8 mm, 10 mm, 12 mm, 16 mm, 20 mm, 25 mm	6 mm, 8 mm, 10 mm, 12 mm, 16 mm, 20 mm, 25 mm, 32 mm	6 mm
Theoretical force at 0.6 MPa (6 bar, 87 psi), advancing	34 ... 589 N	17 ... 483 N	17 N
Stroke	10 ... 200 mm	10 ... 200 mm	10 mm
Cushioning	Short elastic cushioning rings/pads at both ends, Elastomer cushioning, double-sided, stroke not adjustable, Elastic cushioning rings/pads at both ends with fixed stop, Elastic cushioning rings/plates at both ends, External hydraulic cushioning	Short elastic cushioning rings/pads at both ends, No cushioning, Elastic cushioning rings/plates at both ends, Elastic cushioning rings/pads at both ends with fixed stop, Self-adjusting, progressive shock absorber at both ends, with reducing sleeve, Progressive shock absorber at both ends	Elastic cushioning rings/plates at both ends
Position sensing	Via proximity switch	Via proximity switch	Without
Description	<ul style="list-style-type: none"> • Powerful twin-piston drive • Shortest mini slide on the market • Precise recirculating ball bearing guide • Versatile mounting options • Version with mirrored supply port configuration and sensor slots for compact assembly available to order using the configurator • Variants recommended for production systems for manufacturing lithium-ion batteries • Sustainable in production thanks to reduced use of materials 	<ul style="list-style-type: none"> • High load capacity and positioning accuracy • Maximum movement precision thanks to ground-in ball bearing cage guide • Maximum flexibility thanks to 8 sizes and a large selection of cushioning variants • Variants with clamping unit or end-position locking for fixing the guide slide • Wide variety of mounting and attachment options • Compact design 	<ul style="list-style-type: none"> • Smallest guided slide unit on the market • Precision ball bearing cage guide for a reliable and high-quality process • Long service life thanks to housing made from high-alloy steel • Low break-away pressure and uniform movement thanks to minimal friction of guide and seal
online: →	dgst	dgsl	dgsc

Drives with guides >

Drives with slides



Mini slides
SLF







Mini slides
SLS

Piston diameter	6 mm, 10 mm, 16 mm	6 mm, 10 mm, 16 mm
Theoretical force at 0.6 MPa (6 bar, 87 psi), advancing	17 ... 121 N	17 ... 121 N
Stroke	10 ... 80 mm	5 ... 30 mm
Cushioning	Elastic cushioning rings/plates at both ends	Elastic cushioning rings/plates at both ends
Position sensing	Via proximity switch	Via proximity switch
Description	<ul style="list-style-type: none"> • Flat design • Ball bearing cage guide • Versatile mounting options • Easy adjustment of end positions 	<ul style="list-style-type: none"> • Slim design • Ball bearing cage guide • Versatile mounting options
online: →	slf	sls

Product overview

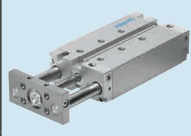



Drives with guides >

Drives with guide rods

	 NEW Guided drives DFM, DFM-B	 Guided drive, NPT DFM	 Guided drives DGRF	 Compact cylinders ADNGF
Piston diameter	6 mm, 10 mm, 12 mm, 16 mm, 20 mm, 25 mm, 32 mm, 40 mm, 50 mm, 63 mm, 80 mm, 100 mm	20 mm, 25 mm, 32 mm, 40 mm, 50 mm, 63 mm	20 mm, 25 mm, 32 mm, 40 mm, 50 mm, 63 mm	12 mm, 16 mm, 20 mm, 25 mm, 32 mm, 40 mm, 50 mm, 63 mm, 80 mm, 100 mm
Theoretical force at 0.6 MPa (6 bar, 87 psi), advancing	17 ... 4712 N	188 ... 1870 N	189 ... 1870 N	68 ... 4712 N
Stroke	5 ... 400 mm	20 ... 400 mm	10 ... 400 mm	1 ... 400 mm
Cushioning	Elastic cushioning rings/plates at both ends, Pneumatic cushioning, adjustable at both ends, Shock absorber, soft characteristic curve	Elastic cushioning rings/plates at both ends, Pneumatic cushioning, adjustable at both ends, Shock absorber, soft characteristic curve	Elastic cushioning rings/plates at both ends, Self-adjusting pneumatic end-position cushioning, Pneumatic cushioning, adjustable at both ends	Elastic cushioning rings/plates at both ends, Self-adjusting pneumatic end-position cushioning
Position sensing	Via proximity switch	Via proximity switch	Via proximity switch	Via proximity switch
NEW	<ul style="list-style-type: none"> New for 01/2022: additional versions 			
Description	<ul style="list-style-type: none"> Drive and guide unit in a single housing High resistance to torques and lateral forces Plain or recirculating ball bearing guide Wide variety of mounting and attachment options Wide range of variants for customised applications Variants recommended for production systems for manufacturing lithium-ion batteries 	<ul style="list-style-type: none"> High resistance to torques and lateral forces Plain or recirculating ball bearing guide Wide variety of mounting and attachment options Wide range of variants for customised applications Drive and guide unit in a single housing 	<ul style="list-style-type: none"> Easy-to-clean design Increased corrosion protection FDA-approved lubrication and sealing on the basic version Hygienic mounting of the sensors possible Compact design with high guide precision and load capacity Long service life thanks to optional dry-running seal Self-adjusting pneumatic end-position cushioning saves time during commissioning and adapts optimally to load and speed changes 	<ul style="list-style-type: none"> ISO 21287 Piston rod secured against rotation by a guide rod and yoke plate Plain bearing Optionally with through piston rod Higher load capacity thanks to guide rod and yoke plate For position sensing
online: →	dfm	dfm	dgrf	adngf

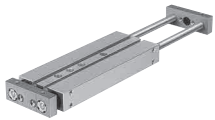

Drives with guides >

Drives with guide rods

	 Mini guided drives DFC	 Twin cylinders DPZ	 Twin cylinders DPZJ	 Twin cylinder DGTZ
Piston diameter	4 mm, 6 mm, 10 mm	10 mm, 16 mm, 20 mm, 25 mm, 32 mm	10 mm, 16 mm, 20 mm, 25 mm, 32 mm	6 mm, 10 mm, 16 mm, 20 mm, 25 mm, 32 mm
Theoretical force at 0.6 MPa (6 bar, 87 psi), advancing	7.5 ... 47 N	60 ... 966 N	60 ... 724 N	18.6 ... 966 N
Stroke	5 ... 30 mm	10 ... 100 mm	10 ... 100 mm	10 ... 200 mm
Cushioning	Elastic cushioning rings/plates at both ends	Elastic cushioning rings/plates at both ends	Elastic cushioning rings/plates at both ends	Elastic cushioning rings/plates at both ends
Position sensing	Via proximity switch, Without	Via proximity switch	Via proximity switch	Via proximity switch
Description	<ul style="list-style-type: none"> • Smallest guided drive • Precise and resilient • Minimal space requirement • Drive and guide unit in a single housing • Plain or recirculating ball bearing guide 	<ul style="list-style-type: none"> • Twin pistons provide twice the force in half the space • Plain or recirculating ball bearing guide • Precision stroke adjustment in the end position 	<ul style="list-style-type: none"> • With yoke plate on rear of cylinder for higher lateral forces and precision • Twin pistons provide twice the force in half the space • Plain or recirculating ball bearing guide • Precision stroke adjustment in the end position 	<ul style="list-style-type: none"> • Minimal space requirement • Minimal mounting time • High resistance to torques and lateral forces • High rigidity thanks to its guide rods with large diameter and two plain-bearing bushes • Wide range of mounting options • Drive and guide unit in a single housing • Plain bearing
online: →	dfc	dpz	dpzj	dgtz

Stopper cylinders and feed separators >

Stopper cylinders

	 Stopper cylinders DFSP	 Stopper cylinders DFST-G2	 Stopper cylinders STAF
Piston diameter	16 mm, 20 mm, 32 mm, 40 mm, 50 mm	32 mm, 50 mm, 63 mm, 80 mm	80 mm
Permissible impact force on the advanced piston rod	710 ... 6280 N	1000 ... 6000 N	13300 ... 14600 N
Stroke	5 ... 30 mm	20 ... 40 mm	30 ... 40 mm
Position sensing	Via proximity switch	Via proximity switch	Via proximity switch
Toggle lever position sensing		Via inductive sensors	
Description	<ul style="list-style-type: none"> • Trunnion version with/without protection against rotation, with/without female thread • Roller version with protection against rotation • Compact design • Sensor slots on 3 sides • Long service life thanks to very good cushioning characteristics and sturdy piston rod guide • Safe stopping of workpiece carriers, pallets and packages weighing up to 90 kg 	<ul style="list-style-type: none"> • Toggle lever design • Integrated, adjustable shock absorber for smooth and adapted stopping • Up to 800 kg impact load • For position sensing on the piston • Adjustable active direction thanks to rotatable toggle lever set-up (90°, 180°, 270°) • Lever locking mechanism • Toggle lever deactivator • Roller version made of polyamide or steel 	<ul style="list-style-type: none"> • Roller version • Absorption of high lateral forces • Direct mounting of solenoid valves on flange plate
online: →	dfsp	dfst	staf

Product overview

Software tools

Feed separator

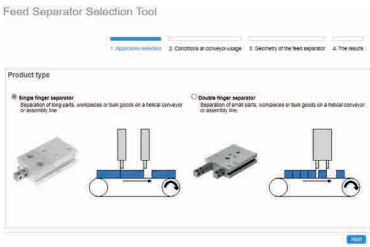



This tool helps you to select the right feed separator of the type HPV from Festo for your application.

Let yourself be guided by the program and enter the general parameters. You will receive at least one suggestion for the product best suited to your application.

This tool can be found at www.festo.com/x/feed-separator-selection-tool

Stopper cylinders and feed separators >

Feed separators

		
	Feed separators HPVS	Feed separators HPV
Mode of operation	Double-acting	Double-acting
Piston diameter	10 mm, 14 mm, 22 mm	10 mm, 14 mm, 22 mm
Stroke	10 ... 60 mm	10 ... 60 mm
Theoretical force at 0.6 MPa (6 bar, 87 psi), advancing	45 ... 225 N	45 ... 225 N
Description	<ul style="list-style-type: none"> • Version with one plunger • With non-rotating piston rod • Proximity sensor SME/SMT-8 can be integrated in the housing 	<ul style="list-style-type: none"> • Version with two plungers • With twin piston, non-rotating piston rod and locking mechanism • Cost-effective: replaces at least two drives in the feed process • Proximity sensor SME/SMT-8 can be integrated in the housing
online: →	hpvs	hpv

Clamping cylinders >

Clamping modules

	
	Clamping modules EV
Clamping area	10x30, 15x40, 15x63, 20x75, 20x120, 20x180, Ø16 mm, Ø20 mm, Ø25 mm, Ø32 mm, Ø40 mm, Ø50 mm, Ø63 mm, Ø12 mm
Stroke	3 ... 5 mm
Description	<ul style="list-style-type: none"> • Compact rodless cylinder with diaphragm • Single-acting, with reset function • Flat design • Hermetically sealed • Pressure plates and foot mounting as accessories
online: →	ev

Clamping cylinders >

Linear/swivel clamps



Linear/swivel clamps
CLR

Piston diameter	12 mm, 16 mm, 20 mm, 25 mm, 32 mm, 40 mm, 50 mm, 63 mm
Theoretical clamping force at 0.6 MPa (6 bar, 87 psi)	51 ... 1682 N
Clamping stroke	10 ... 50 mm
Swivel angle	90° +/- 2°, 90° +/- 3°, 90° +/- 4°
Description	<ul style="list-style-type: none"> • Swivelling and clamping in one step • Adjustable swivel direction • Available with clamping fingers as accessories • Available with dust and welding spatter protection • Double-acting • For position sensing
online: →	clr

Clamping cylinders >

Hinge cylinders



Hinge cylinders
DWA, DWB, DWC

Piston diameter	50 mm, 63 mm, 80 mm
Stroke	10 ... 200 mm
Theoretical force at 0.6 MPa (6 bar, 87 psi), advancing	1178 ... 3016 N
Position sensing	Via proximity switch, Without
Cushioning	Pneumatic cushioning, adjustable at both ends
Description	<ul style="list-style-type: none"> • For clamping components during the welding process • Double-acting • Easy to mount thanks to swivel bearing on the bearing cap • Integrated flow control • Integrated end-position cushioning • Rod wiper seal to protect against welding spatter • Asian automotive standard for car body production
online: →	dw

Product overview

Bellows and diaphragm drives >

Bellows actuators



Bellows cylinder
EB

Size	80, 145, 165, 215, 250, 325, 385
Stroke	20 ... 230 mm
Description	<ul style="list-style-type: none"> • Use as a spring element or for reducing oscillations • Single- or double-bellows cylinder • High forces with a short stroke • Uniform movement: no stick-slip effect • Use in dusty environments or in water • Maintenance-free
online: →	eb

Bellows and diaphragm drives >

Fluidic muscles



Fluidic muscles
DMSP

Size	5, 10, 20, 40
Theoretical force at 0.6 MPa (6 bar, 87 psi)	140 ... 6000 N
Nominal length	30 ... 9000 mm
Max. contraction	20% of nominal length, 25% % of the nominal length
Description	<ul style="list-style-type: none"> • With press-fitted connection • Up to 30% less weight: a superb force/weight ratio • Single-acting, pulling • 3 integrated adapter variants • 10 times the initial force of a comparable pneumatic cylinder • Uniform movement: no stick-slip effect • Hermetically sealed design offers protection against dust, dirt and moisture
online: →	dmsp

Software tools

Rotary indexing table

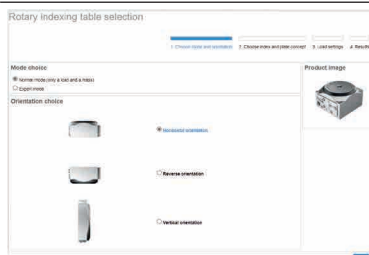

This tool helps you to select the right rotary indexing table of the type DHTG from Festo for your application.

Let yourself be guided by the program and enter the general parameters. You will receive at least one suggestion for the product best suited to your application.

This tool can be found at

→ www.festo.com/x/rotary-indexing-table-selection

Rotary indexing tables >



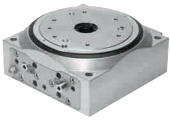

Rotary indexing tables

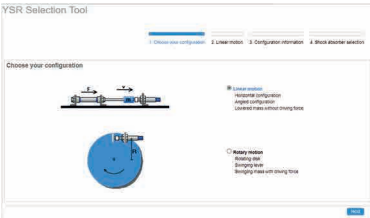
	 <p>Rotary indexing tables DHTG</p>
Size	65, 90, 140, 220
Theoretical torque at 0.6 MPa (6 bar, 87 psi)	2.1 ... 58.9 Nm
Indexing stations	2 ... 24
Description	<ul style="list-style-type: none"> • For swivelling or separating tasks • Sturdy mechanical system • Easy planning and commissioning • Rotary table diameters: 65, 90, 140, 220 mm • Free control of rotational direction
online: →	dhtg

Software tools



<p>Shock absorber</p> 	<p>All types of cushioned movements, whether diagonal or vertical, curved or straight, lever or disc, are taken into account. The software tool always recommends the best shock absorber.</p> <p>This tool can be found at → www.festo.com/x/shock-absorber-selection-tool</p>
---	--

Shock absorbers



	 <p>Shock absorbers DYSS</p>	 <p>Shock absorbers DYSR</p>	 <p>Shock absorbers YSR-C</p>	 <p>Shock absorbers YSRW</p>
Size	2, 3, 4, 5, 7, 8, 10, 12	8, 12, 16, 20, 25, 32	4, 5, 7, 8, 10, 12, 16, 20, 25, 32	5, 7, 8, 10, 12, 16, 20
Stroke	4 ... 12 mm	8 ... 60 mm	4 ... 60 mm	8 ... 34 mm
Max. energy absorption per stroke	0.1 ... 10 J	4 ... 384 J	0.6 ... 380 J	1.3 ... 70 J
Cushioning	Self-adjusting	Adjustable	Self-adjusting	Self-adjusting, Soft characteristic curve
Description	<ul style="list-style-type: none"> • Hydraulic shock absorber with path-controlled flow control function • Rapidly increasing cushioning force curve • Short cushioning stroke • Suitable for low-vibration operation 	<ul style="list-style-type: none"> • Hydraulic shock absorber with spring return • Adjustable cushioning hardness 	<ul style="list-style-type: none"> • Hydraulic shock absorber with path-controlled flow control function • Rapidly increasing cushioning force curve • Short cushioning stroke • Suitable for rotary drives 	<ul style="list-style-type: none"> • Hydraulic shock absorber with path-controlled flow control function • Gently increasing cushioning force curve • Long cushioning stroke • Suitable for low-vibration operation • Short cycle times possible
online: →	dyss	dysr	ysr-c	ysrw

Product overview

Shock absorbers





	 Shock absorbers YSRW-DGC	 Shock absorbers YSRWJ	 Shock absorbers DYEF-Y1, DYEF-Y1F ★
Size	8, 12, 18, 25, 32, 40, 50, 63	5, 7, 8	M10, M12, M14, M16, M22, M4, M5, M6, M8
Stroke		8 ... 14 mm	0.9 ... 7 mm
Max. energy absorption per stroke		1 ... 3 J	0.005 ... 1.2 J
Cushioning	Self-adjusting, Soft characteristic curve	Self-adjusting, Soft characteristic curve	Elastic cushioning rings/pads at both ends with metal fixed stop, Elastic cushioning rings/pads at both ends without metal fixed stop
Description	<ul style="list-style-type: none"> • For linear drives DGC • Gently increasing cushioning force curve 	<ul style="list-style-type: none"> • Cushioning with self-adjusting, progressive hydraulic shock absorber • Gently increasing cushioning force curve • Adjustable cushioning stroke • End-position sensing with proximity sensor SME/SMT-8 • Precision end-position adjustment 	<ul style="list-style-type: none"> • Mechanical shock absorber with flexible rubber buffer • Flexible rubber buffer allows a defined metal end position • Adjustable cushioning hardness • Ideal for cushioning low energy • With precise metal end position
online: →	ysrw-dgc	ysrwj	dyef

Shock absorbers

	 Shock absorbers DYSC	 Shock absorbers DYSW	 Hydraulic cushioning cylinders DYHR
Size	4, 5, 7, 8, 12, 16, 20, 25	4, 5, 7, 8, 10, 12	16, 20, 25, 32
Stroke	4 ... 25 mm	6 ... 20 mm	20 ... 60 mm
Max. energy absorption per stroke	0.6 ... 100 J	0.8 ... 12 J	32 ... 384 J
Cushioning	Self-adjusting	Self-adjusting, Soft characteristic curve	Adjustable
Description	<ul style="list-style-type: none"> • Hydraulic shock absorber with path-controlled flow control function • Rapidly increasing cushioning force curve • Short cushioning stroke • Suitable for rotary drives • With metal fixed stop 	<ul style="list-style-type: none"> • Hydraulic shock absorber with path-controlled flow control function • Gently increasing cushioning force curve • Long cushioning stroke • Suitable for low-vibration operation • Short cycle times possible • With metal fixed stop 	<ul style="list-style-type: none"> • Hydraulic cushioning cylinder for constant, slow braking speeds across the entire stroke • Braking speed can be precisely adjusted • A built-in compression spring returns the piston rod to the initial position • Suitable for slow feed speeds in the range up to 0.1 m/s
online: →	dysc	dysw	dyhr

Cylinder mounting parts and accessories

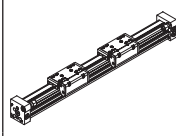



Accessories for pneumatic drives

	 Mounting components ★	 Piston-rod attachments ★	 Guide axes DGC-FA	 Guide units FEN, FENG
Size	6, 8, 8/10, 8/12, 12, 12/16, 12/18, 16, 18, 18/25, 20, 20/25, 25, 25/32, 30, 32, 32/40, 40, 40/50, 50, 50/63, 63, 63/80, 80, 100, 100/125, 125, 160, 160/200, 200, 250, 320, M10x1, M18x1.5, M22x1.5, M30x1.5, M8	6, 8, 10, 12, 16, 20, 20/25, 25, 32, 32/40, 35, 40, 50, 50/63, 63, 10x30, 15x40, 15x63, 20x75, 20x120, 20x180, M10, M10x1.25, M12, M12x1.25, M16, M16x1.5, M20x1.5, M27x2, M36x2, M4, M42x2, M48x2, M5, M6, M8		8/10, 12/16, 20, 25, 32, 40, 50, 63, 80, 100
Stroke			1 ... 8500 mm	1 ... 500 mm
Round material to be clamped				
Static holding force				
Performance level (PL)				
Description	<ul style="list-style-type: none"> • Mounting kits • Direct mountings • Foot mountings • Flange mountings • Swivel mountings • Clevis feet, trunnion supports • Multi-position kits • Slot nuts • Centring pins/sleeves 	<ul style="list-style-type: none"> • Rod clevises • Rod eyes • Coupling pieces • Self-aligning rod couplers • Adapter 	<ul style="list-style-type: none"> • Without drive • With recirculating ball bearing guide • With guide and freely movable slide unit • High torsional resistance • Reduced vibrations with dynamic loads • For supporting forces and torques in multi-axis applications 	<ul style="list-style-type: none"> • For protecting standards-based cylinders against rotation at high torque loads • Plain or recirculating ball bearing guide • High guide precision for workpiece handling
online: →	n_015001	n_03150	dgc-fa	fen

Product overview

Cylinder mounting parts and accessories

Accessories for pneumatic drives

	 Clamping cartridges KP	 Clamping units KPE	 Clamping units, clamping components DADL	 Holding brakes DACS
Size			16, 20, 25, 32, 35, 40, 50, 63	
Stroke				
Round material to be clamped	4 ... 32 mm	4 ... 32 mm		16 ... 40 mm
Static holding force	80 ... 7500 N	80 ... 7500 N		1350 ... 17000 N
Performance level (PL)				Stopping, holding, blocking a movement/category 1, Performance Level c
Description	<ul style="list-style-type: none"> For in-house assembly of clamping units Not certified for use in safety-related control systems 	<ul style="list-style-type: none"> Ready-to-install combination of clamping cartridge KP and housing Wide range of mounting options 	<ul style="list-style-type: none"> Clamping unit DADL-EL for semi-rotary drive DRRD, for mechanical locking in the end positions to prevent unwanted movement when unpressurised Clamping component DADL-EC: for semi-rotary drive DRRD, for securing an intermediate position in combination with the clamping unit DADL-EL Without drive 	<ul style="list-style-type: none"> Holding function: retains the piston rod by clamping with frictional locking Emergency braking function: stops the movement of the piston rod by clamping with frictional locking With safety functions Compact design Optional: high level of corrosion protection For position sensing
online: →	kp	kpe	dadl	dacs

Customised components – for your specific requirements



Drives with customised designs

Can't find the pneumatic drive you need in our catalogue?

We can offer you customised components that are tailored to your specific requirements.

Common product modifications:

- Materials for special environmental conditions
- Customised dimensions
- Special strokes
- Customised mounting options
- Implementation of special cylinder functions (cylinder/valve combinations, single-acting principle, etc.)

Many additional variants are possible.

Ask your Festo sales engineer, who will be happy to help you:

→ www.festo.com/contact

Telescopic cylinder



Festo can also supply special variants like telescopic cylinders on request – please contact us.

Product overview

01

Pneumatic drives

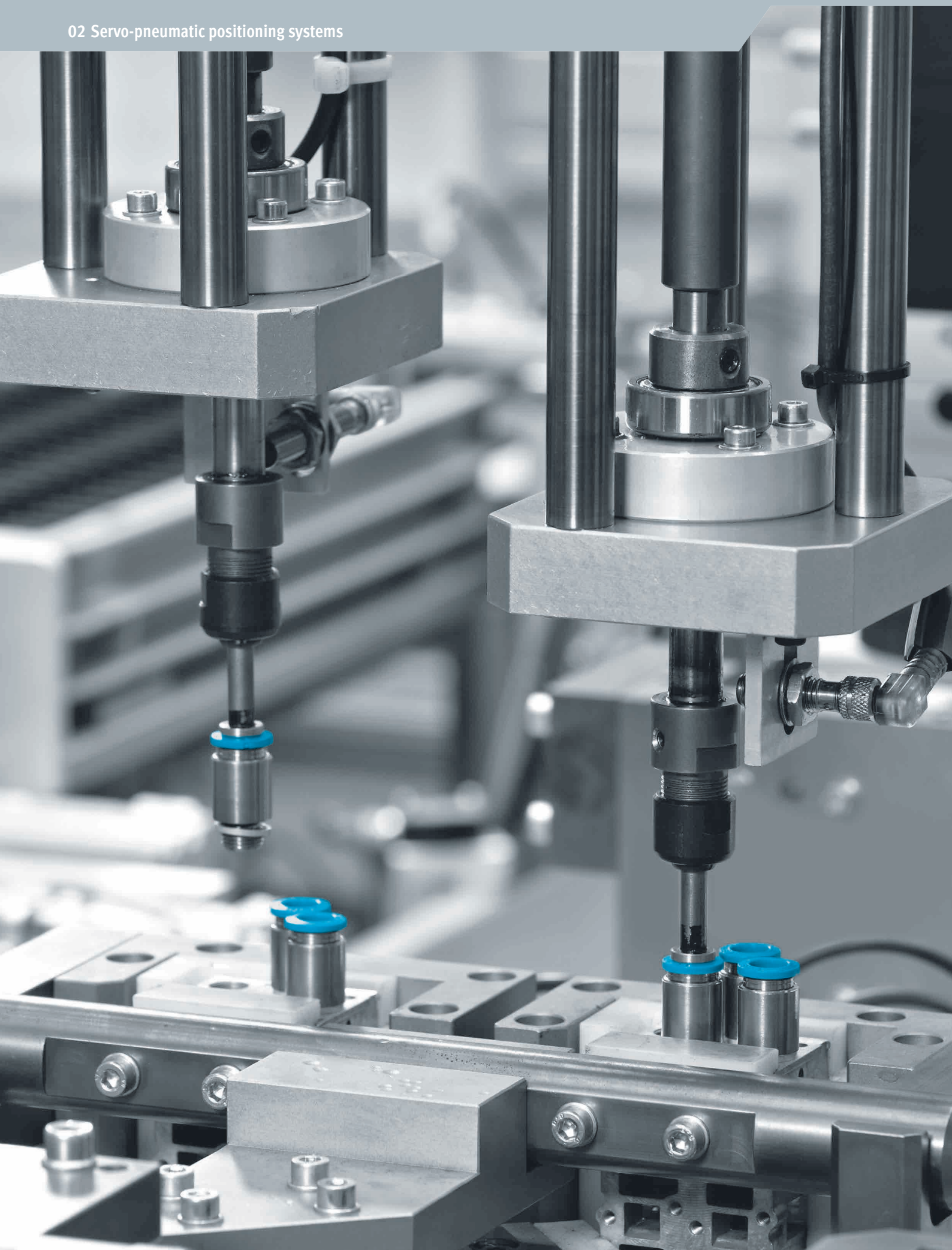

Product overview

Software tools

02 Servo-pneumatic positioning systems

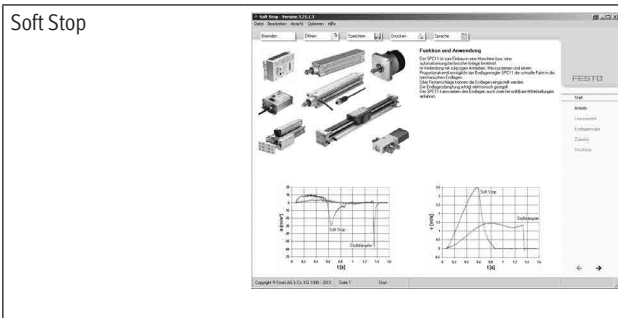



Soft Stop virtually makes the impossible possible. Travel times for pneumatic drives are reduced by as much as 30% and vibration is also greatly reduced. The selection program performs all the necessary calculations.

- This tool can be found
- at www.festo.com
 - Enter “soft stop” in the search field
 - Via the “Support / Downloads” tab
 - in the list under “Software”



Drives with displacement encoder >

Linear actuators with displacement encoder

	 Linear actuators with displacement encoder DFPI	 Linear actuators with displacement encoder DFPI-NB3	 Linear drives with displacement encoder DDLI
Piston diameter	100 mm, 125 mm, 160 mm, 200 mm, 250 mm, 320 mm	100 mm, 125 mm, 160 mm, 200 mm, 250 mm, 320 mm	25 mm, 32 mm, 40 mm, 63 mm
Theoretical force at 0.6 MPa (6 bar, 87 psi), advancing	4712 ... 48255 N	4712 ... 48255 N	295 ... 1870 N
Max. load, horizontal			2 ... 180 kg
Max. load, vertical			2 ... 60 kg
Stroke	40 ... 990 mm	40 ... 990 mm	100 ... 2000 mm
Description	<ul style="list-style-type: none"> • Mounting interfaces for process valves to DIN EN ISO 5210 • Integrated air supply • Optionally with integrated displacement encoder or fully integrated positioner • IP65, IP67, IP69K, NEMA4 • To EU Explosion Protection Directive (ATEX) 	<ul style="list-style-type: none"> • Mounting interfaces to ISO 15512 on bearing and end caps • Robust and corrosion-resistant tie-rod design • Optionally with integrated displacement encoder or fully integrated positioner • IP65, IP67, IP69K, NEMA4 • To EU Explosion Protection Directive (ATEX) 	<ul style="list-style-type: none"> • Based on linear drive DGC-K • Without guide • With displacement encoder for contactless measurement • Suitable for positioning with axis controller CPX-CMAX • Suitable for end-position control with end-position controller CPX-CMPX or SPC11 • Measures absolute values • Can be used as a measuring cylinder • Degree of protection IP67 • For attachment to customer's own guide • Supply ports on end face
online: →	dfpi	dfpi	ddli

Drives with displacement encoder >

Linear actuators with displacement encoder

			
	Standards-based cylinders with displacement encoder DDPC	Standards-based cylinders with displacement encoder DNCI	Linear drives with displacement encoder DGCI
Piston diameter	80 mm, 100 mm	32 mm, 40 mm, 50 mm, 63 mm	18 mm, 25 mm, 32 mm, 40 mm, 63 mm
Theoretical force at 0.6 MPa (6 bar, 87 psi), advancing	3016 ... 4712 N	415 ... 1870 N	153 ... 1870 N
Max. load, horizontal	300 ... 450 kg	45 ... 180 kg	1 ... 180 kg
Max. load, vertical	100 ... 150 kg	15 ... 60 kg	1 ... 60 kg
Stroke	10 ... 2000 mm	10 ... 2000 mm	100 ... 2000 mm
Description	<ul style="list-style-type: none"> Standards-based cylinder to ISO 15552 With displacement encoder for contactless measurement Suitable for positioning with axis controller CPX-CMAX Suitable for end-position control with end-position controller CPX-CMPX or SPC11 Can be used as a measuring cylinder Piston rod variants Fixed cushioning With optional recirculating ball bearing guide, clamping unit 	<ul style="list-style-type: none"> Standards-based cylinder to ISO 15552 With integrated displacement encoder for relative analogue, contactless measurement Suitable for servo-pneumatic applications with axis controller CPX-CMAX, end-position controller CPX-CMPX or SPC11 and measuring module CPX-CMIX Piston rod with male thread Piston rod variants With optional recirculating ball bearing guide, clamping unit 	<ul style="list-style-type: none"> With guide With displacement encoder for absolute, contactless measurement Suitable for servo-pneumatic applications with axis controller CPX-CMAX, end-position controller CPX-CMPX or SPC11 and measuring module CPX-CMIX Choice of supply ports on end face or front
online: →	ddpc	dnci	dgci



Drives with displacement encoder >

Swivel modules with displacement encoder



	
	Semi-rotary drives with angular displacement encoder DSMI-B
Piston diameter	40 mm
Theoretical torque at 0.6 MPa (6 bar, 87 psi)	20 Nm
Max. mass moment of inertia, horizontal	0.12 kgm ²
Max. mass moment of inertia, vertical	0.12 kgm ²
Swivel angle	0 ... 272 deg
Description	<ul style="list-style-type: none"> With rotary vane Integrated rotary potentiometer Suitable for servo-pneumatic applications with axis controller CPX-CMAX, end-position controller CPX-CMPX or SPC11 and measuring module CPX-CMIX Compact design
online: →	dsmi

Product overview

Axis controllers



	 Axis controllers CPX-CMAX	 End-position controllers CPX-CMPX	 End-position controllers SPC11
No. of axis strings	1	1	
Axes per string	1	1	
Digital inputs			8, To IEC 61131-2, Positive logic (PNP), No galvanic isolation
Digital outputs			5
Description	<ul style="list-style-type: none"> • Axis controller as CPX module, supports pneumatic drives with piston rod, rodless drives and semi-rotary drives • Force and position control • Use with all fieldbuses/Ethernet and controllers CEC available on CPX • Easy commissioning thanks to auto identification function • Rapid commissioning and comprehensive diagnostics with FCT configuration software (Festo Configuration Tool) 	<ul style="list-style-type: none"> • Electronic end-position control for pneumatic drives • Soft Stop for smooth braking and quick acceleration • Use with all fieldbuses/Ethernet available on CPX • Easy commissioning with Festo plug plug & work • Approx. 30% shorter travel times and 30% less air consumption than with comparable standard pneumatics • End positions with 2 additional, freely positionable intermediate positions 	<ul style="list-style-type: none"> • Quickly and smoothly into the end position with 2 additional intermediate positions • Electronic end-position cushioning • Quick and easy commissioning: configure, teach, done • Supports pneumatic drives with piston rod, rodless drives and semi-rotary drives
online: →	cpx-cmax	cpx-cmpx	spc11

Displacement encoders



	 Displacement encoders MLO-POT-TLF	 Displacement encoders MLO-POT-LWG	 Displacement encoders MME-MTS-TLF
Stroke	225 ... 2000 mm	100 ... 750 mm	225 ... 2000 mm
Measuring principle of displacement encoder	Analogue	Analogue	Digital
Output signal	Analogue	Analogue	CAN protocol type SPC-AIF
Displacement resolution	0.01 mm	0.01 mm	<0.01 mm
Description	<ul style="list-style-type: none"> • Conductive plastic potentiometer • Absolute measurement with high resolution • High travel speed and long service life • Plug-in connections 	<ul style="list-style-type: none"> • Connecting rod potentiometer • Absolute measurement with high resolution • Long service life • Degree of protection IP65 • Plug-in connections 	<ul style="list-style-type: none"> • Measuring principle: magnetostrictive • Contactless with absolute measurement • High travel speed • System product for servo-pneumatic positioning technology and Soft Stop • Degree of protection IP65
online: →	mlo	mlo	mme

Proportional directional control valves

Proportional valves

			
	Proportional directional control valves VPWP	Proportional directional control valves MPYE	Proportional directional control valves VPWS
Valve function	5/3-way proportional directional control valve, closed	5/3 closed	2/2 proportional directional control valve, closed
Pneumatic connection 1	G1/4, G1/8, G3/8	G1/4, G1/8, G3/8, M5	Cartridge 7.5 mm, Cartridge 15 mm
Operating pressure for positioning/Soft Stop	4 ... 8 bar		
Operating pressure [MPa]	0 ... 1 MPa	0 ... 1 MPa	
Operating pressure	0 ... 10 bar	0 ... 10 bar	0 ... 8 bar
Standard nominal flow rate	350 ... 2000 l/min	100 ... 2000 l/min	
Description	<ul style="list-style-type: none"> Controlled piston spool valve Digitally actuated Integrated pressure sensors for monitoring function and force control With auto identification Diagnostic function Integrated digital output, e.g. for a clamping/brake unit Suitable for servo-pneumatic applications with axis controller CPX-CMAX and end-position controller CPX-CMPX 	<ul style="list-style-type: none"> Controlled piston spool valve Analogue actuation Setpoint input as analogue voltage signal (0 ... 10 V) Suitable for servo-pneumatic applications with end-position controller SPC11 	<ul style="list-style-type: none"> Directly actuated poppet valve Operating medium: air, oxygen, inert gases Extremely small and lightweight Compact and cost-effective Mounting: on sub-base
online: →	vpwp	mpye	vpws

Sensor interfaces

		
	Sensor interfaces CASM	Measured-value transducers DADE
Diagnostic function	Display via LED	Display via LED
Electrical connection, displacement encoder	Socket, 8-pin, 5-pin, M12	Socket, 8-pin, M12
Electrical connection, control interface	Plugs, 5-pin, M9	
Control interface	Digital, CAN bus with Festo protocol, Without terminating resistor	
Description	<ul style="list-style-type: none"> For controlling pneumatic positioning drives with the latest servo-pneumatic systems such as CPX-CMAX, CPX-CMPX and CPX-CMIX Short cables for analogue signals, secure digitised bus transmission Convenient plug and work concept with auto identification and comprehensive diagnostics High degree of protection IP67 	<ul style="list-style-type: none"> For standards-based cylinders DNCI and DDPC Converts sensor signals into voltage or current signals Mounting via through-holes
online: →	casm	dade

Product overview

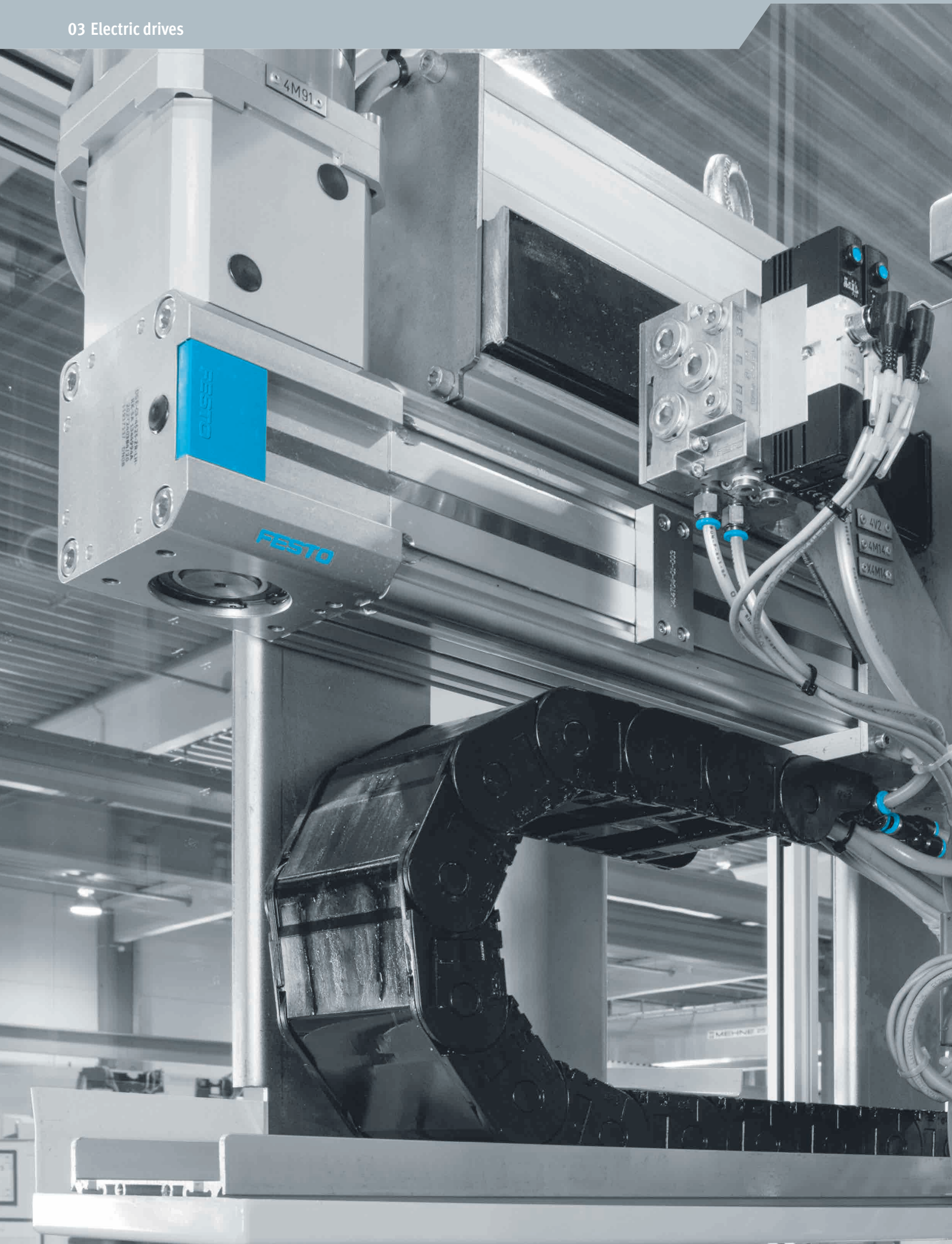

02

Servo-pneumatic positioning systems







Product overview



Software tools

Electric Motion Sizing		<p>Find the right electric or electromechanical servo drive.</p> <p>This is how you can quickly and easily find the right electromechanical drive solution for your application:</p> <p>Electric Motion Sizing, the online sizing and simulation tool for electric drives (servo drives and motors = servo drive package) as well as for electromechanical drive solutions (= electromechanical servo drive package consisting of servo drives and motors as well as mechanics) helps you do this.</p> <p>This tool can be found at → www.festo.com/x/electric-motion-sizing</p>
Simplified Motion Series – Solution Finder		<p>The simplicity of pneumatics is now combined for the first time with the advantages of electric automation thanks to the Simplified Motion Series.</p> <p>These integrated drives are the perfect solution for all users who are looking for an electric alternative for very simple movement and positioning tasks, but don't want the commissioning process for traditional electric drive systems that can often be quite complex.</p> <p>This tool can be found at → www.festo.com/x/simplified-motion-series</p>
CO2 & TCO Guide		<p>CO2 values and TCO for your application.</p> <p>Take a quantum leap in automation technology. By using suitable components from Festo in an intelligent way, you can reduce the energy consumption of your systems and thus specifically lower your production's carbon emissions.</p> <p>This tool can be found at → www.festo.com/x/co2-tco</p>

Electric axes



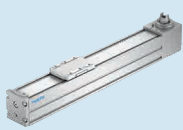
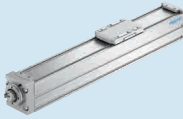

	 Toothed belt axes EGC-TB-KF ★	 Spindle axes EGC-BS-KF ★	 Toothed belt axes EGC-HD-TB	 Spindle axes EGC-HD-BS
Size	50, 70, 80, 120, 185	70, 80, 120, 185	125, 160, 220	125, 160, 220
Max. feed force Fx	50 ... 2500 N	400 ... 3000 N	450 ... 1800 N	400 ... 1500 N
Repetition accuracy	+/-0.08 mm, +/-0.1 mm	+/-0.02 mm		+/-0.02 mm
Working stroke	50 ... 8500 mm	50 ... 3000 mm	50 ... 5000 mm	50 ... 2400 mm
Description	<ul style="list-style-type: none"> • Axis for high speeds and acceleration • Recirculating ball bearing guide for high loads and torques • Optionally with clamping unit, at one or both ends • Profile with optimised rigidity • 22 types in stock with short delivery times and modular products for custom variants 	<ul style="list-style-type: none"> • Axis for high repeat accuracy • Recirculating ball bearing guide for high loads and torques • Optionally with clamping unit, at one or both ends • Profile with optimised rigidity • Various spindle pitches • The optional spindle support enables maximum travel speed • Axial or parallel motor mounting 	<ul style="list-style-type: none"> • With heavy-duty guide • Axis for high speeds and acceleration • For high loads and torques, high feed forces • Precise and resilient DUO guide rail • Motor can be mounted on 4 sides • For maximum lateral load up to 900 Nm 	<ul style="list-style-type: none"> • With heavy-duty guide • Axis for high repeat accuracy • With integrated ball screw • For maximum loads and torques • Precise and resilient DUO guide rail • For maximum lateral load up to 900 Nm • Ideal as a basic axis for linear gantries and cantilever axes • The optional spindle support enables maximum travel speed
online: →	egc	egc	egc	egc

Electric axes

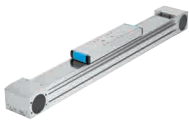

	 Toothed belt axes ELGC-TB-KF ★ NEW	 Spindle axes ELGC-BS-KF ★ NEW	 Spindle axes ELGT-BS	 Spindle axes ELGA-BS-KF
Size	45, 60, 80	32, 45, 60, 80	90, 120, 160	70, 80, 120, 150
Max. feed force F _x	75 ... 250 N	40 ... 350 N	805 ... 1575 N	650 ... 6400 N
Repetition accuracy	+/-0.1 mm	+/-0.01 mm, +/-0.015 mm	+/-0.02 mm	+/-0.02 mm
Working stroke	200 ... 2000 mm	100 ... 1000 mm	50 ... 1400 mm	50 ... 3000 mm
NEW	<ul style="list-style-type: none"> New for 12/2021: additional versions 	<ul style="list-style-type: none"> New for 12/2021: additional versions 		
Description	<ul style="list-style-type: none"> Precision guide rail with high load capacity Internal guide and toothed belt Flexible motor mounting The toothed belt axes, spindle axes ELGC and mini slides EGSC form a scalable modular system for compact automation Variants recommended for production systems for manufacturing lithium-ion batteries 	<ul style="list-style-type: none"> Internal guide and ball screw drive Space-saving position sensing Flexible motor mounting The toothed belt axes, spindle axes ELGC and mini slides EGSC form a scalable modular system for compact automation Variants recommended for production systems for manufacturing lithium-ion batteries 	<ul style="list-style-type: none"> Great resilience and rigidity due to double-acting guide Compact design With ball screw drive Optimal ratio between installation space and working space due to the optimised axis design Simple integration of motors with mounting kits Optimised for use in the electronics and automotive industry 	<ul style="list-style-type: none"> Internal, precision recirculating ball bearing guide with high load capacity for high torque loads Guide and ball screw protected by cover strip For the highest requirements in terms of feed force and accuracy Speeds up to 2 m/s with high acceleration up to 15 m/s² Space-saving position sensing Flexible motor mounting 34 preconfigured types and modular product system for custom variants
online: →	elgc-tb	elgc-bs	elgt	elga

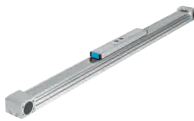
Product overview

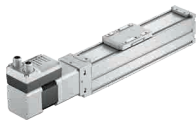

Electric axes

				
	Toothed belt axes ELGA-TB-G	Toothed belt axes ELGA-TB-KF	Toothed belt axes ELGA-TB-RF	Toothed belt axis units ELGS-TB-KF
Size	70, 80, 120	70, 80, 120, 150	70, 80, 120	45, 60
Max. feed force Fx	350 ... 1300 N	260 ... 2000 N	260 ... 1000 N	65 ... 75 N
Repetition accuracy	+/-0.08 mm	+/-0.08 mm	+/-0.08 mm	+/-0.1 mm
Working stroke	50 ... 8500 mm	50 ... 8500 mm	50 ... 7400 mm	50 ... 2000 mm
Description	<ul style="list-style-type: none"> • Integrated plain-bearing guide • For small and medium loads • Low guide backlash • Drive component for external guides • Speeds up to 5 m/s with high acceleration up to 50 m/s² • Flexible motor mounting • Motor can be mounted on 4 sides 	<ul style="list-style-type: none"> • Recirculating ball bearing guide for high loads and torques • High feed forces • Precision guide rail with high load capacity • Speeds up to 5 m/s with high acceleration up to 50 m/s² • Optional: Food-safe (for further information, see www.festo.com/certificates/ELGA_KF) • Flexible motor mounting • Guide and toothed belt protected by cover band • 22 types in stock with short delivery times and modular products for custom variants 	<ul style="list-style-type: none"> • Integrated roller bearing guide • High speeds up to 10 m/s with high acceleration up to 50 m/s² • Guide backlash = 0 mm • Very good operating performance under torque load • Sturdy alternative for the recirculating ball bearing guide • As an actuator for external guides, especially for high speeds • Motor can be mounted on 4 sides 	<ul style="list-style-type: none"> • Complete solution consisting of integrated drive, motor and servo drive • Resilient toothed belt with long service life • Ideal for precise XY movements, e.g. in assembly plants or when handling small parts as well as for test and inspection systems • Protected against external influences by internal guide • Clean look design: easy to clean and less prone to soiling • Integrated end position sensing • Two control options integrated as standard: digital I/O and IO-Link • Easy commissioning according to the plug and work principle: all parameters are manually adjustable directly on the drive without requiring any software or special expertise • Two sizes with speeds of up to 1.3 m/s at a max. stroke of 2000 mm • Product of the Simplified Motion Series: doesn't need any external servo drive or any control cabinet for the installation
online: →	elga	elga	elga	elgs-tb

Electric axes



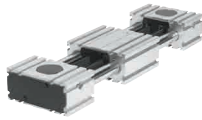

			
	Spindle axis units ELGS-BS-KF	Toothed belt axis units ELGE-TB	Toothed belt axes ELGG
Size	32, 45, 60	35	35, 45, 55
Max. feed force Fx	40 ... 200 N	50 N	50 ... 350 N
Repetition accuracy	+/-0.01 mm, +/-0.015 mm	+/-0.1 mm	+/-0.1 mm
Working stroke	100 ... 800 mm	50 ... 800 mm	50 ... 1200 mm
Description	<ul style="list-style-type: none"> • Complete solution consisting of integrated drive, motor and servo drive • Powerful ball screw drive • Ideal for precise XY movements, e.g. in assembly plants or when handling small parts as well as for test and inspection systems • Protected against external influences by internal guide • Clean look design: easy to clean and less prone to soiling • Integrated end position sensing • Two control options integrated as standard: digital I/O and IO-Link • Easy commissioning according to the plug and work principle: all parameters are manually adjustable directly on the drive without requiring any software or special expertise • Three sizes for a payload of up to 20 kg at a max. stroke of 800 mm • Product of the Simplified Motion Series: doesn't need any external servo drive or any control cabinet for the installation 	<ul style="list-style-type: none"> • Complete solution consisting of integrated drive, motor and servo drive • Cost-optimised design for easy motion and positioning tasks between two mechanical end positions as well as intermediate positions • Running performance of 5000 km • Freely selectable motor mounting position on four sides • Integrated end position sensing • Two control options integrated as standard: digital I/O and IO-Link • Easy commissioning according to the plug and work principle: all parameters are manually adjustable directly on the drive without requiring any software or special expertise • Product of the Simplified Motion Series: doesn't need any external servo drive or any control cabinet for the installation 	<ul style="list-style-type: none"> • Toothed belt axis with two opposing slides • With low-cost plain bearing and precise ball bearing guide • Optional central support improves the rigidity • Motor can be mounted on 4 sides
online: →	elgs-bs	elge-tb	elgg

Electric axes

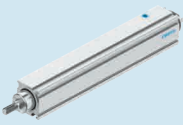

		
	Toothed belt axes ELGR-TB	Cantilever axes ELCC-TB-KF
Size	35, 45, 55	60, 70, 90, 110
Max. feed force Fx	50 ... 350 N	300 ... 2500 N
Repetition accuracy	+/-0.1 mm	+/-0.05 mm
Working stroke	50 ... 1500 mm	50 ... 2000 mm
Description	<ul style="list-style-type: none"> • Optimum price/performance ratio • Ready-to-install unit for quick and easy design • With plain or recirculating ball bearing guide • Motor can be mounted on 4 sides 	<ul style="list-style-type: none"> • Stationary drive head • Toothed belt drive with recirculating ball bearing guide • High rigidity thanks to innovative design principle • Very small moving mass • Able to move high loads of up to 100 kg vertically
online: →	elgr	elcc

Product overview



Electric cylinders and slides

	 Electric cylinder units EPCS-BS	 Electric cylinder units EPCE-TB	 NEW ★ Electric cylinder EPCC-BS	 NEW ★ Electric cylinders ESBF
Size	32, 45, 60	45, 60	25, 32, 45, 60	32, 40, 50, 63, 80, 100
Max. feed force Fx	150 ... 900 N	85 ... 150 N	75 ... 1000 N	600 ... 17000 N
Repetition accuracy	+/-0.02 mm	+/-0.05 mm	+/-0.02 mm	+/-0.01 mm, +/-0.015 mm, +/-0.05 mm
Stroke	25 ... 500 mm	10 ... 80 mm	25 ... 500 mm	30 ... 1500 mm
NEW			• New for 12/2021: additional versions	• New for 09/2021: additional versions
Description	<ul style="list-style-type: none"> • Complete solution consisting of integrated drive, motor and servo drive • Extremely cost-effective, yet powerful and very flexible • Ideal for individual linear movements in every installation position and especially for vertical Z movements • Precise positioning thanks to smoothly running ball screw drive • Compact dimensions • Safe movement through flexible position sensing • Integrated end position sensing • Two control options integrated as standard: digital I/O and IO-Link • Easy commissioning according to the plug and work principle: all parameters are manually adjustable directly on the drive without requiring any software or special expertise • Product of the Simplified Motion Series: doesn't need any external servo drive or any control cabinet for the installation 	<ul style="list-style-type: none"> • Complete solution consisting of integrated compact cylinder, motor and controller • Cost-optimised design for easy motion and positioning tasks between two mechanical end positions as well as intermediate positions • Minimal zero stroke and extremely compact design make this product the perfect choice for applications where space is at a premium • Two sizes with 5 ... 80 mm stroke, can be selected in 5 mm increments • Innovative interpretation of toothed belt technology for maximum dynamic response and minimal positioning times • Ideal for fast movement in sorting, distribution and testing applications • Up to two piston rods per electric cylinder unit can be selected at the same time in four different mounting positions and different combinations • Integrated end position sensing • Two control options integrated as standard: digital I/O and IO-Link • Easy commissioning according to the plug and work principle: all parameters are manually adjustable directly on the drive without requiring any software or special expertise • Product of the Simplified Motion Series: doesn't need any external servo drive or any control cabinet for the installation 	<ul style="list-style-type: none"> • Low-cost: optimum price/performance ratio • Flexible: wide range of mounting options for the motor • Dynamic: lower internal friction • Non-rotating piston rod with plain-bearing guide, stroke up to 500 mm • Weight-optimised design – ideal for handling systems • Unique: “One-size-down” assembly system for the best use of space in combination with toothed belt/spindle axis ELGC • Variants recommended for production systems for manufacturing lithium-ion batteries 	<ul style="list-style-type: none"> • Available with ball screw drive (size 32 ... 100) or lead screw (size 32 ... 50) • Ball screw: with three spindle pitches for selecting the optimal force-speed ratio • Optional: high corrosion protection, degree of protection IP65, food-safe (see www.festo.com/certificates/ESBF), piston rod extension • Axial or parallel motor mounting • 68 types in stock with short delivery times and modular products for custom variants • Variants recommended for production systems for manufacturing lithium-ion batteries
online: →	epcs	epce	epcc	esbf

Electric cylinders and slides





		 NEW	
	Electric cylinders EPCO	Mini slides EGSC-BS-KF	Mini slide units EGSS-BS
Size	16, 25, 40	25, 32, 45, 60	32, 45, 60
Max. feed force Fx	50 ... 650 N	20 ... 250 N	60 ... 250 N
Repetition accuracy	+/-0.02 mm	+/-0.015 mm	+/-0.015 mm
Stroke	50 ... 400 mm	25 ... 200 mm	25 ... 200 mm
NEW		• New for 12/2021: additional versions	
Description	<ul style="list-style-type: none"> • Linear drive with permanently attached motor • With ball screw drive • Optional: encoder, holding brake and female thread on the piston rod • Two different spindle pitches for high force or high speed • Suitable for simple applications in factory automation that in the past were mostly carried out using pneumatic solutions • Optional: precise and backlash-free guide 	<ul style="list-style-type: none"> • Precise guide and ball screw drive • Compact dimensions • Flexible motor mounting • The toothed belt axes, spindle axes ELGC and mini slides EGSC form a scalable modular system for compact automation • Variants recommended for production systems for manufacturing lithium-ion batteries 	<ul style="list-style-type: none"> • Complete solution consisting of integrated drive, motor and servo drive • For precise vertical Z movements or individual guided linear movements • Very high-quality ball screw drive with low internal friction • Rigid, high load-bearing and precise linear guide for absorbing lateral forces and increased anti-twist protection • Integrated end position sensing • Two control options integrated as standard: digital I/O and IO-Link • Easy commissioning according to the plug and work principle: all parameters are manually adjustable directly on the drive without requiring any software or special expertise • Product of the Simplified Motion Series: doesn't need any external servo drive or any control cabinet for the installation
online: →	epco	egsc-bs	egss

Electric cylinders and slides

		
	Mini slides EGSL-BS	Electric slides EGSK
Size	35, 45, 55, 75	15, 20, 26, 33, 46
Max. feed force Fx	75 ... 450 N	19 ... 392 N
Repetition accuracy	+/-0.015 mm	+/-0.003 - +/-0.004 mm, +/-0.003 - +/-0.01 mm, +/-0.01 mm
Stroke	50 ... 300 mm	25 ... 840 mm
Description	<ul style="list-style-type: none"> • Very high rated slide load, ideal for vertical applications such as press-fitting or joining • Reliable: the completely closed spindle stops dirt or stray small parts getting into the guide area • Axial or parallel motor mounting 	<ul style="list-style-type: none"> • Electromechanical linear axis with ball screw drive • Recirculating ball bearing guide and ball screw without caged ball bearings • Standardised mounting interfaces • Compact design • High rigidity • 22 types in stock with short delivery times and modular products for custom variants
online: →	egsl	egsk

Product overview



Electric semi-rotary drives

	 Rotary drive units ERMS	 Rotary drives ERMO	 Rotary modules ERMB	 Front units ERMH
Size	25, 32	12, 16, 25, 32	20, 25, 32	8, 11
Max. driving torque	2.7 ... 5.6 Nm	0.15 ... 5 Nm	0.7 ... 8.5 Nm	0.75 ... 4.5 Nm
Max. input speed			900 ... 1350 rpm	
Max. rotational speed	100 ... 150 rpm	100 ... 200 rpm		
Rotation angle	Infinite, 90°, 180°	Infinite	Infinite	Infinite
Description	<ul style="list-style-type: none"> • Complete solution consisting of integrated drive, motor and servo drive • Cost-effective solution package for simple swivel tasks, but also for applications with high loads • Sealed hollow shaft for the integrated through-feed of cables and tubing • Standardised mounting interface for direct connection to the electric mini slides EGSL, EGSC and EGSS • Integrated end position sensing • Two control options integrated as standard: digital I/O and IO-Link • Easy commissioning according to the plug and work principle: all parameters are manually adjustable directly on the drive without requiring any software or special expertise • Product of the Simplified Motion Series: doesn't need any external servo drive or any control cabinet for the installation 	<ul style="list-style-type: none"> • Electric rotary drive with stepper motor and integrated gear unit • ServoLite – closed-loop operation with encoder • Heavy-duty bearing for high forces and torques • Backlash-free, pre-stressed rotating plate with very good axial eccentricity and concentricity properties • Quick and accurate installation • For simple rotary indexing table applications and as a rotary axis in multi-axis applications 	<ul style="list-style-type: none"> • Electromechanical rotary module with toothed belt • Compact design • Mounting interfaces on all sides • Stable output shaft bearings • Unlimited and flexible rotation angle 	<ul style="list-style-type: none"> • For linear gantry system EXCT and parallel kinematic system EXPT • Electromechanical rotary module with servo motor and gear unit • Gear ratio 30:1 • With or without air throughfeed • With optional pneumatic rotary through-feed (for vacuum and gauge pressure) • Max. output speed: 200 rpm
online: →	erms	ermo	ermb	ermh



Electric stopper cylinders

	 Stopper cylinders, electric EFS
Design	Electric stopper cylinder
Size	20, 50, 100
Position sensing	With Hall sensor
Cushioning length	11.5 ... 18.2 mm
Description	<ul style="list-style-type: none"> • Fast and simple set-up of transfer systems without compressed air • For stopping conveyed goods weighing between 0.25 kg and 100 kg • Status and error messages for visual error diagnostics • Controlled via digital I/O of a higher-order controller, e.g. terminal CPX, makes commissioning easier • Mounting interface for ease of mounting on transfer systems • Adjustable cushioning power
online: →	efsd

Electric handling modules

	 Rotary gripper modules EHMD	 Rotary/lifting modules EHMB	 Handling modules EHMX
Size	40	20, 25, 32	
Stroke per gripper jaw	5 mm, 15 mm		
Working stroke		0 ... 200 mm	200 ... 4500 mm
Max. output torque	0.3 Nm		
Max. driving torque		0.7 ... 6.7 Nm	
Max. input speed		900 ... 1350 rpm	
Max. acceleration			15 ... 50 m/s ²
Max. speed			0.8 m/s, 1 m/s, 3 m/s, 5 m/s
Rotation angle	Infinite	Infinite	
Repetition accuracy			+/-0.01 mm, +/-0.08 mm, +/-0.1 mm
Description	<ul style="list-style-type: none"> • Ideal for small objects in laboratory automation • Infinite electrical rotation and electrical or pneumatic gripping • Gripping and turning to open and close covers on vials • Optional: mounting with Z-compensation compensates for the thread pitch of covers on vials during opening and closing 	<ul style="list-style-type: none"> • Complete module with combined and configurable rotary/lifting movement • Dynamic, flexible, economical thanks to the modular drive concept for the linear movement • Hollow axis with large internal diameter makes laying power supply lines easy, convenient and safe 	<ul style="list-style-type: none"> • For creating 3D gantries for the YXCR series • For X-axis movements in 3-dimensional gantries
online: →	ehmd	ehmb	ehmx



Electric handling modules

	 Handling modules EHMY	 Handling modules EHMZ
Size		
Stroke per gripper jaw		
Working stroke	50 ... 4500 mm	50 ... 1000 mm
Max. output torque		
Max. driving torque		
Max. input speed		
Max. acceleration	15 ... 50 m/s ²	15 ... 25 m/s ²
Max. speed	0.6 m/s, 0.8 m/s, 1 m/s, 1.5 m/s, 3 m/s, 5 m/s	0.3 m/s, 0.4 m/s, 0.5 m/s, 0.6 m/s, 0.65 m/s, 1 m/s, 1.3 m/s, 1.5 m/s, 3 m/s
Rotation angle		
Repetition accuracy	+/-0.01 mm, +/-0.015 mm, +/-0.08 mm, +/-0.1 mm	+/-0.015 mm, +/-0.02 mm, +/-0.05 mm
Description	<ul style="list-style-type: none"> • For creating 3D gantries for the YXCR series • For Y-axis movements in 3-dimensional gantries 	<ul style="list-style-type: none"> • For creating 2-dimensional and 3-dimensional gantries for the YXCL and YXCR series • For Z-axis movements in 2-dimensional and 3-dimensional gantries
online: →	ehmy	ehmz

Product overview

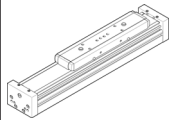

Accessories for electric drives >

Linear guides

			
	Guide axes ELFC	Guide units EAGF	Guide axes ELFA-KF
Size	32, 45, 60, 80	16, 25, 32, 40, 50, 63, 80, 100	70, 80, 120
Stroke	100 ... 2000 mm	1 ... 550 mm	50 ... 8500 mm
Guide	Recirculating ball bearing guide	Recirculating ball bearing guide	Recirculating ball bearing guide
Description	<ul style="list-style-type: none"> • Driveless linear guide unit with guide and freely movable slide unit • High torsional resistance • Reduced vibrations with dynamic loads 	<ul style="list-style-type: none"> • For electric cylinders EPCO and ESBF • For absorbing high process forces and torques • High guide precision 	<ul style="list-style-type: none"> • For spindle/toothed belt axes ELGA-BS/ELGA-TB (drive axes) • Driveless linear guide unit with guide and freely movable slide unit • For supporting forces and torques in multi-axis applications • High torsional resistance • Reduced vibrations with dynamic loads
online: →	elfc	eagf	elfa

Accessories for electric drives >

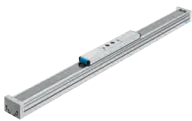
Linear guides

			
	Guide axes ELFA-RF	Guide axes ELFR	Guide axes EGC-FA
Size	70, 80	35, 45, 55	70, 80, 120, 185
Stroke	50 ... 7000 mm	50 ... 1500 mm	50 ... 8500 mm
Guide	Roller bearing guide	Plain-bearing guide, Recirculating ball bearing guide	Recirculating ball bearing guide
Description	<ul style="list-style-type: none"> • For toothed belt axis ELGA-TB (drive axes) • Driveless linear guide unit with guide and freely movable slide unit • For supporting forces and torques in multi-axis applications • High torsional resistance • Reduced vibrations with dynamic loads 	<ul style="list-style-type: none"> • For toothed belt axes ELGR (drive axes) • For spindle/toothed belt axes ELGA (drive axes) • For supporting forces and torques in multi-axis applications • High torsional resistance 	<ul style="list-style-type: none"> • For spindle/toothed belt axes ELGA (drive axes) • For supporting forces and torques in multi-axis applications • High torsional resistance
online: →	elfa	elfr	egc

Customised components – for your specific requirements



Drives with customised designs

Can't find the electromechanical drive you need in our catalogue?

We can offer you customised components that are tailored to your specific requirements.

Common product modifications:

- Special strokes
- Design for special environmental conditions
- Design optimised for the installation space
- Design with opposing carriages
- Design with absolute encoder

Many additional variants are possible.

Ask your Festo sales engineer, who will be happy to help you:

→ www.festo.com/contact

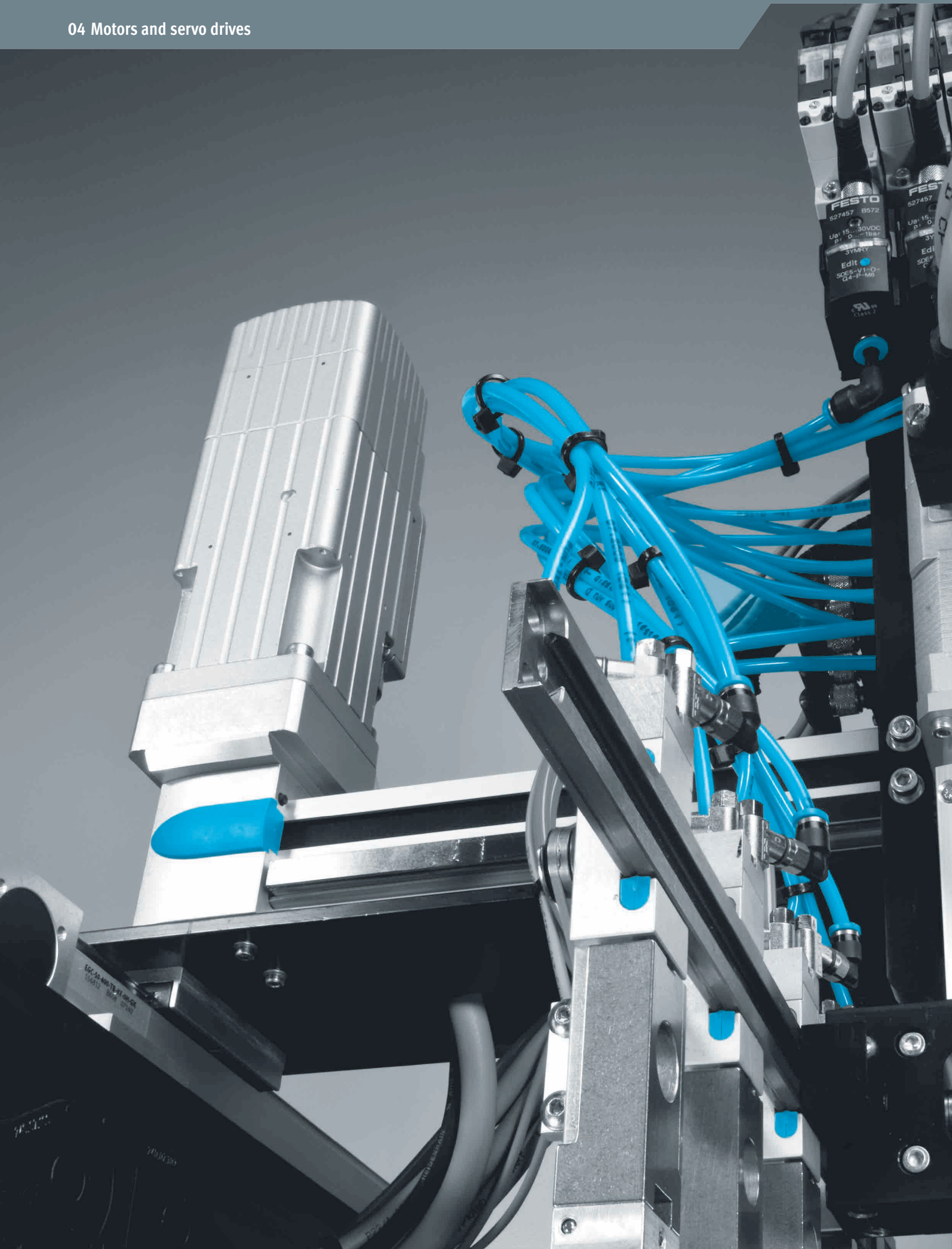

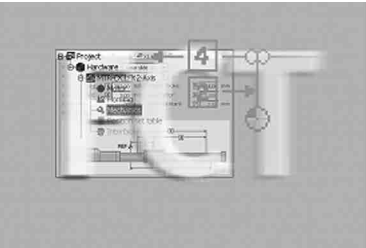
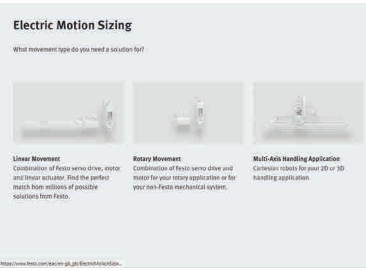
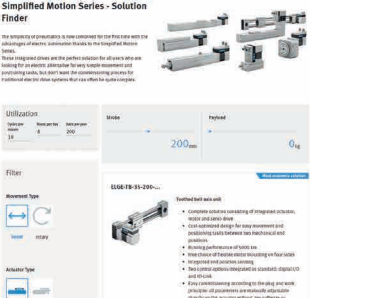

Product overview

Software tools

<p>Festo Configuration Tool (FCT)</p>		<p>The “Festo Configuration Tool” is a configuration and parameterisation software program that supports all Festo devices, in particular motor controllers.</p> <p>The software is extremely flexible, provides full support for the device properties and is simple and intuitive to operate. The user is guided step-by-step through the commissioning process while each individual step is checked.</p> <p>The “Festo Configuration Tool” parameterisation software can be found at</p> <ul style="list-style-type: none"> • www.festo.com/fct > section “Other useful tools for the first start”
<p>Electric Motion Sizing</p>		<p>Find the right electric or electromechanical servo drive.</p> <p>This is how you can quickly and easily find the right electromechanical drive solution for your application:</p> <p>Electric Motion Sizing, the online sizing and simulation tool for electric drives (servo drives and motors = servo drive package) as well as for electromechanical drive solutions (= electromechanical servo drive package consisting of servo drives and motors as well as mechanics) helps you do this.</p> <p>This tool can be found at</p> <ul style="list-style-type: none"> • www.festo.com/x/electric-motion-sizing
<p>Simplified Motion Series – Solution Finder</p>		<p>The simplicity of pneumatics is now combined for the first time with the advantages of electric automation thanks to the Simplified Motion Series.</p> <p>These integrated drives are the perfect solution for all users who are looking for an electric alternative for very simple movement and positioning tasks, but don't want the commissioning process for traditional electric drive systems that can often be quite complex.</p> <p>This tool can be found at</p> <ul style="list-style-type: none"> • www.festo.com/x/simplified-motion-series

Servo motors

			
	Servo motors EMMB-AS	Servo motors EMMT-AS	★ Servo motors EMME-AS
Nominal torque	0.32 ... 2.39 Nm	0.6 ... 82.4 Nm	0.12 ... 6.4 Nm
Nominal rotary speed	3000 rpm	1000 ... 3500 rpm	3000 ... 9000 rpm
Nominal motor power	100 ... 750 W	190 ... 8629 W	110 ... 2000 W
Peak torque	0.96 ... 7.17 Nm	1.6 ... 183.3 Nm	0.7 ... 30 Nm
Max. rotational speed	5000 ... 6000 rpm	1654 ... 15000 rpm	3910 ... 10000 rpm
Description	<ul style="list-style-type: none"> • Very cost-effective • Brushless, permanently magnetized synchronous servo motor • Digital absolute displacement encoder, single turn; multi-turn optional • Reliable, dynamic, precise • Especially designed for simple positioning tasks in the electronics industry, small parts assembly and in test stations • Optimised connection technology • Degree of protection IP40 (motor shaft without rotary shaft seal), IP54 (motor shaft with rotary shaft seal), IP65 (motor housing without connection technology) • Different winding variants • Optionally with holding brake 	<ul style="list-style-type: none"> • Brushless, permanently magnetized synchronous servo motor • Digital absolute displacement encoder, single turn or multi-turn • Extremely low cogging torque – supports high synchronisation even at low rotational speeds • Simple connection technology (OCP: one cable plug) – one connecting cable for supply and encoder • Rotatable plug with adjustable angle (310°) • Optionally with holding brake 	<ul style="list-style-type: none"> • Brushless, permanently magnetized synchronous servo motor • Digital absolute displacement encoder, single turn or multi-turn • Reliable, dynamic, precise • Optimised connection technology • Variants with safety encoder absolute, multi turn, HIPERFACE® • Degree of protection IP54 (on the motor shaft without radial shaft seal), IP65 (on the motor shaft with radial shaft seal), IP65 (for motor housing and power/encoder connections) • Optionally with holding brake
online: →	emmb	emmt	emme

Stepper motors

		★
	Stepper motors EMMS-ST	
Nominal motor current	1.4 ... 9.5 A	
Max. rotational speed	430 ... 6000 rpm	
Motor holding torque	0.09 ... 9.3 Nm	
Description	<ul style="list-style-type: none"> • Small increments and high driving torques thanks to 2-phase hybrid technology • Optimised connection technology • Four sizes with flange sizes 28, 42, 57 and 87 • 28 types in stock • With incremental encoder for closed-loop operation • Degree of protection IP40 (motor shaft), IP54 (sizes 42, 27, 87: motor housing and plug connection), IP65 (size 28: motor housing and plug connection) • Optionally with holding brake 	
online: →	emms	

Product overview

Motors with integrated servo drives



Integrated drives
EMCA

Nominal torque	0.37 ... 0.45 Nm
Nominal rotary speed	3100 ... 3150 rpm
Nominal motor power	120 ... 150 W
Max. rotational speed	3300 ... 3500 rpm
Peak torque	0.85 ... 0.91 Nm
Description	<ul style="list-style-type: none"> • 64 freely programmable position sets • Convenient web diagnostics • Digital absolute displacement encoder, single-turn and multi-turn, with buffering • Degree of protection IP54 as standard, optionally IP65 • Control via CANopen, EtherNet/IP, I/O interface, PROFINET and EtherCAT® and Modbus® TCP
online: →	emca

Software tools

Festo Automation Suite
commissioning
software



Quickly and reliably to a ready-to-use drive system – the Festo Automation Suite combines the parameterisation, programming and maintenance of complete drive systems, from the mechanical to the control system, in just one software program.

Perfect for making industrial automation simple, efficient and seamless.

Servo drive plug-in CMMT-AS



- An operational drive system in just 5 steps – parameterisation is almost fully automatic with the commissioning wizard
- Advanced editing with the expert view gives you full access to all device parameters
- Conveniently install the plug-in using the software

This tool can be found

- on our website at www.festo.com/AutomationSuite

Electric servo drives >



Servo drive

	 Servo drives CMMT-AS	 Motor controllers CMMP-AS
Nominal current		2 ... 13 A
Nominal operating voltage AC	230 ... 400 V	230 ... 400 V
Nominal operating voltage phases	Single-phase, 3-phase	Single-phase, 3-phase
Rated output controller	350 ... 6000 VA	500 ... 9000 VA
Fieldbus coupling	EtherCAT, EtherNet/IP, PROFINET	CANopen, DeviceNet, EtherCAT, EtherNet/IP, Modbus/TCP, PROFINET, PROFIBUS DP
Safety function	Safe brake control (SBC), Safe torque off (STO), Safe Stop 1 (SS1)	Safe torque off (STO), Safe Stop 1 (SS1)
Performance level (PL)	Safe brake control (SBC)/category 3, performance level e, Safe Torque Off (STO)/category 4, performance level e	Safe Torque Off (STO)/category 4, performance level e
Description	<ul style="list-style-type: none"> • One of the most compact servo drives on the market • Precise force, speed and position control • Auto-tuning supports easy commissioning and automatically optimises the control behaviour of rotary and linear motions • The latest generation of servo drive systems with optimised prices and sizes • With safety functions • Configuration of standard safety functions without software • MP variant with multi-protocol: the required bus protocol can be selected using the commissioning software Festo Automation Suite or directly on the servo drive • Optimally with servo motor EMMT-AS • Universal applications • Sustainable operation thanks to energy recovery 	<ul style="list-style-type: none"> • Many interfaces and functions for decentralised motion functions (flying saw, flying measurement, modulo function, etc.) • Optional: integrated cam disk controllers and highly dynamic movements • Standardised interfaces allow seamless integration in mechatronic multi-axis modular systems • Reliable and easy commissioning and parameterisation with the Festo Configuration Tool (FCT) • Optionally with 3 slots for extension modules • Variants with safety functions • 255 positioning records
online: →	cmmt-as	cmmp



Product overview

Electric servo drives >



Stepper motor controllers

	 Servo drives CMMT-ST	 Motor controllers CMMS-ST
Nominal current load supply	8 A	8 A
Nominal voltage, load supply DC	24 V, 48 V	48 V
Fieldbus coupling	EtherCAT, Modbus/TCP, EtherNet/IP, PROFINET	CANopen, PROFIBUS DP
Performance level (PL)	STO/Cat. 3, PLd (EC motor without diagnostics), STO/Cat. 3, PLc (stepper motor/EC motor with diagnostics)	Safe Torque Off (STO)/category 3, performance level d
Description	<ul style="list-style-type: none"> • Very efficient for tasks with low power requirements • Ideal for positioning tasks and point-to-point and interpolating motion solutions • 50% more compact than the smallest servo drive CMMT-AS • 150 W at 24 V DC, 300 W at 48 V DC • With safety functions • Optimised for use with stepper motors like the tried-and-tested EMMS-ST 	<ul style="list-style-type: none"> • For controlling stepper motors EMMS-ST and Optimised Motion Series (for electric cylinders EPCO, toothed belt axes ELGR, rotary drives ERMO) • Easy and convenient commissioning and firmware updates via SD card slot • Reliable and easy commissioning and parameterisation with the Festo Configuration Tool (FCT) • Integrated process interface: digital I/O, CAN, RS485 • With safety functions • Optional: PROFIBUS and DeviceNet®
online: →	cmmt-st	cmms

Gear units



	 Gear unit EMGA-A	 Gear units EMGA-P-EAS	 Gear units EMGA-P-SAS
Gear ratio	12:1, 20:1, 3:1, 5:1, 8:1	12:1, 20:1, 3:1, 5:1, 8:1	12:1, 20:1, 3:1, 5:1, 8:1
Continuous output torque	4.5 ... 120 Nm	6 ... 120 Nm	22 ... 450 Nm
Max. drive speed	7000 ... 18000 rpm	7000 ... 18000 rpm	6500 ... 13000 rpm
Torsional rigidity	0.7 ... 5.1 Nm/arcmin	0.85 ... 10.4 Nm/arcmin	2.3 ... 38 Nm/arcmin
Torsional backlash	0.22 ... 0.41 deg	0.12 ... 0.31 deg	0.1 ... 0.17 deg
Mass moment of inertia, gear unit	0.032 ... 1.409 kgcm ²	0.015 ... 0.77 kgcm ²	0.078 ... 12.14 kgcm ²
Max. efficiency	92%, 93%, 94%, 95%	96%, 97%, 98%	96%, 97%, 98%
Description	<ul style="list-style-type: none"> • Bevel gear for servo motors EMME-AS, EMMT-AS, EMMS-AS • Life-time lubrication • Degree of protection IP54 	<ul style="list-style-type: none"> • Planetary gear unit, straight, for servo motors EMME-AS, EMMT-AS • Eco AC synchronous interface • Life-time lubrication • Degree of protection IP54 	<ul style="list-style-type: none"> • Planetary gear unit, straight, for servo motors EMME-AS • AC synchronous interface • Life-time lubrication • Degree of protection IP54
online: →	emga	emga	emga

Gear units

	 Gear units EMGA-P-SST	★	 Gear units EMGCA	 Gear units EMGC-P
Gear ratio	12:1, 3:1, 5:1, 8:1		1:1	10:1, 12:1, 16:1, 20:1, 25:1, 35:1, 3:1, 40:1, 4:1, 5:1, 7:1
Continuous output torque	6 ... 120 Nm		2 Nm	5 ... 44 Nm
Max. drive speed	7000 ... 18000 rpm		4500 rpm	6000 rpm
Torsional rigidity	0.8 ... 10.4 Nm/arcmin		0.105 Nm/arcmin	0.65 ... 2.4 Nm/arcmin
Torsional backlash	0.12 ... 0.31 deg		0.67 deg	0.5 ... 0.67 deg
Mass moment of inertia, gear unit	0.015 ... 0.77 kgcm ²		0.09 kgcm ²	0.04 ... 0.4 kgcm ²
Max. efficiency	96%, 97%, 98%		90%	92%, 94%
Description	<ul style="list-style-type: none"> Planetary gear unit, straight, for stepper motors EMMS-ST Life-time lubrication Degree of protection IP54 		<ul style="list-style-type: none"> Angle gear for integrated drive EMCA Life-time lubrication Degree of protection IP54 	<ul style="list-style-type: none"> Planetary gear units, straight, one-stage or two-stage, for integrated drives EMCA Life-time lubrication Degree of protection IP54
online: →	emga		emgc	emgc

Accessories for open- and closed-loop position controllers >

Accessories for servo drives

	 Safety modules CAMC-G-S1	 Safety modules CAMC-G-S3
Safety function	Safe torque off (STO)	Safe brake control (SBC), Safe Speed Range (SSR), Safe Speed Monitor (SSM), Safe torque off (STO), Safely limited speed (SLS), Safe Operating Stop (SOS), Safe Stop 1 (SS1), Safe Stop 2 (SS2)
Safety integrity level (SIL)	Safe torque off (STO)/SIL 3/SILCL 3	Safe stop 2 (SS2)/SIL 3, Safe stop 1 (SS1)/SIL 3, Safe brake control (SBC)/SIL 3, Safely limited speed (SLS)/SIL 3, Safe operating stop (SOS)/SIL 3, Safe speed monitor (SSM)/SIL 3, Safe Speed Range (SSR)/SIL 3, Safe torque off (STO)/SIL 3
Characteristics of logic inputs	Galvanically isolated	4 safe, 2-channel inputs Equivalent/antivalent switching Test pulses configurable Function configurable, 6 safe, 1-channel inputs Test pulses configurable
No. of digital logic inputs	2	10
Digital output design	Potential-free signal contact	Potential-free signal contact, 3 safe, 2-channel semiconductor outputs
Description	<ul style="list-style-type: none"> With safety functions For motor controller CMMP-AS-M3 Plug-in module 	<ul style="list-style-type: none"> With safety functions For motor controller CMMP-AS-M3 Plug-in module
online: →	camc	camc

Product overview

Accessories for open- and closed-loop position controllers >

Power supply units



Power supply units
CACN

Nominal output voltage DC	24 ... 48 V
Nominal output current	5 ... 20 A
Input voltage range AC	100 ... 500 V
Power failure buffering	15 ... 100 ms
Description	<ul style="list-style-type: none"> • H-rail mounting • Mounting position: free convection
online: →	cacn

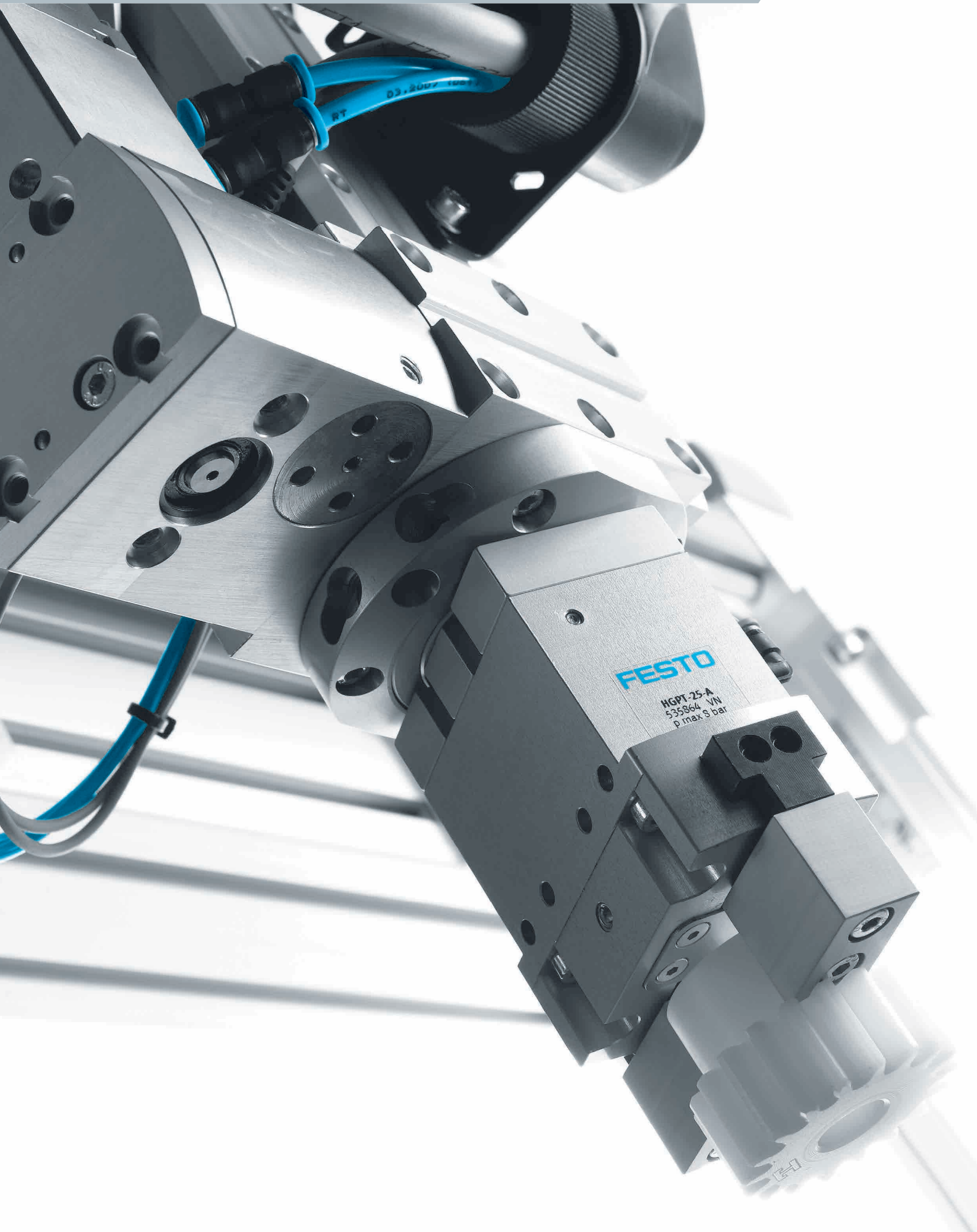

Product overview

Software tools

Product Finder for grippers



A secure grip is a question of the right calculation. In this case, calculation of weight, direction of movement, distances, etc.





The software tool immediately determines which type of gripper – parallel, three-point, angle or swivel gripper – and which size best matches your requirements.

These tools can be found at

- ➔ www.festo.com/x/gripper-parallel
- ➔ www.festo.com/x/gripper-3-point
- ➔ www.festo.com/x/gripper-angle
- ➔ www.festo.com/x/gripper-radial





Mechanical grippers >

Parallel grippers

	 <div style="position: absolute; top: -20px; right: -20px; background-color: #0070C0; color: white; padding: 2px 5px; font-weight: bold;">NEW</div> <p>Parallel gripper DHPC</p>	 <p>Parallel grippers DHPS</p>	 <p>Parallel grippers HGP</p>	 <p>Parallel grippers HGPD</p>
Size	6, 10, 16, 20, 25, 32, 40	6, 10, 16, 20, 25, 35	16, 25	16, 20, 25, 35, 40, 50, 63, 80
Stroke per gripper jaw	2 ... 15 mm	2 ... 12.5 mm	5 ... 7.5 mm	3 ... 20 mm
Total gripping force at 0.6 MPa (6 bar, 87 psi), closing	7.8 ... 717.2 N	25 ... 910 N	160 ... 340 N	94 ... 3716 N
Max. force on gripper jaw Fz, static	5 ... 245 N	10 ... 450 N	90 ... 240 N	150 ... 6000 N
Gripping force backup		During opening, During closing		During opening, During closing
Gripper repetition accuracy	≤0.02 mm	≤0.02 mm	≤0.04 mm	≤0.03 mm, ≤0.04 mm, ≤0.05 mm
Position sensing	Via proximity switch	Via Hall sensor, Via proximity switch	Via proximity switch	Via proximity switch
NEW	<ul style="list-style-type: none"> New for 07/2021: additional versions 			
Description	<ul style="list-style-type: none"> Resilient and precise ball guide High gripping force and compact size Max. repetition accuracy Can be used as a double-acting or single-acting gripper Single-acting variant or with gripping force retention normally open (NO) or normally closed (NC) Suitable for external and internal gripping Wide variety of mounting and attachment options Sustainable in production thanks to reduced use of materials 	<ul style="list-style-type: none"> Sturdy and precise T-slot guidance of the gripper jaws High gripping force and compact size Max. repetition accuracy Can be used as a double- and single-acting gripper Single-acting variant or with gripping force backup, normally open (NO) or normally closed (NC) Suitable for external and internal gripping Wide range of adaptation options on the drives 	<ul style="list-style-type: none"> High gripping force and compact size Self-centring With protective dust cap for use in dusty environments (degree of protection IP54) Max. repetition accuracy Internal fixed flow control Versatile thanks to externally adaptable gripper fingers Double-acting piston drive Suitable for external and internal gripping Wide range of adaptation options on the drives 	<ul style="list-style-type: none"> Ideal for very harsh environments Precise gripping even at high torque load Max. gripping force at optimum installation space/force ratio 8 sizes with total stroke of up to 40 Can be used as a double- and single-acting gripper Single-acting variant or with gripping force backup, normally open (NO) or normally closed (NC) Suitable for external and internal gripping
online: ➔	dhpc	dhps	hgp	hgpd

Mechanical grippers >



Parallel grippers

	 Parallel grippers HGPL-B	 Parallel gripper HPPF	 Parallel gripper DHPL	 Parallel grippers HGPM
Size	14, 25, 40, 63	8, 12, 16, 20	10, 16, 20, 25, 32, 40	8, 12
Stroke per gripper jaw	20 ... 150 mm	4 ... 40 mm	10 ... 100 mm	2 ... 3 mm
Total gripping force at 0.6 MPa (6 bar, 87 psi), closing	158 ... 2742 N	60.32 ... 377 N	38 ... 992 N	16 ... 35 N
Max. force on gripper jaw Fz, static	500 ... 9000 N	58 ... 294 N	40 ... 750 N	10 ... 30 N
Gripping force backup				
Gripper repetition accuracy	0.03 mm	0.02 mm, 0.03 mm, 0.06 mm	0.03 mm	0.05 mm
Position sensing	Via proximity switch	Gripping: slot for proximity switch	Via proximity switch	Without
Description	<ul style="list-style-type: none"> • Space-saving, high forces and torques • Controlled, precise and centred gripping • Long stroke: long guide length for the gripper jaws • Opening stroke can be adjusted to optimise time • Double-acting gripper with two pistons operating in parallel and in opposite directions • Suitable for external and internal gripping 	<ul style="list-style-type: none"> • Double-acting piston drive • Resilient and precise ball guide • High gripping force and compact size • Low height, ideal for applications with limited installation space • Optionally with adjustable stroke 	<ul style="list-style-type: none"> • High torque resistance due to guided gripper jaw • Compact and sturdy design • Ideal for gripping larger parts • Double-acting piston drive • Suitable for external and internal gripping • Mounting: direct fastening via thread, with through-hole • For position sensing with proximity sensor for T-slot and for C-slot • Sustainable in production thanks to reduced use of materials 	<ul style="list-style-type: none"> • Micro gripper: compact, handy design • Versatile thanks to externally adaptable gripper fingers • Single-acting gripper, optionally with open (NO) or closed (NC) gripper jaws • Mounting options with clamping flange, with flange mounting, with Z-stroke compensation
online: ➔	hgpl	hppf	dhpl	hgpm

Product overview



Mechanical grippers >

Parallel grippers

	 <p>Parallel grippers HGPP</p>	 <p>Parallel grippers HGPT-B</p>	 <p>Parallel grippers, electric EHPS</p>
Size	10, 12, 16, 20, 25, 32	16, 20, 25, 35, 40, 50, 63, 80	16, 20, 25
Stroke per gripper jaw	2 ... 12.5 mm	1.5 ... 25 mm	10 ... 16 mm
Total gripping force at 0.6 MPa (6 bar, 87 psi), closing	80 ... 830 N	106 ... 6300 N	Please refer to documentation in the Internet
Max. force on gripper jaw F _z , static	40 ... 720 N	200 ... 7000 N	200 ... 450 N
Gripping force backup	During opening, During closing	During opening, During closing	
Gripper repetition accuracy	0.02 mm	0.03 mm, 0.04 mm, 0.05 mm	0.01 mm, 0.03 mm
Position sensing	Via Hall sensor, Via inductive sensors	Via proximity switch	Via proximity switch, With Hall sensor, With integrated displacement encoder, Via IO-Link interface
Description	<ul style="list-style-type: none"> • High-precision gripper jaw guide • Very flexible thanks to versatile attachment, mounting and application options • Can be used as a double- and single-acting gripper • Single-acting variant or with gripping force backup, normally open (NO) or normally closed (NC) • Suitable for external and internal gripping 	<ul style="list-style-type: none"> • Sturdy and powerful • With T-slot guide • Gripper jaw guide protected by sealing air against dust • High-force variant available • Can be used as a double- and single-acting gripper • Single-acting variant or with gripping force backup, normally open (NO) or normally closed (NC) • Suitable for external and internal gripping 	<ul style="list-style-type: none"> • Electric version of the pneumatically actuated parallel gripper DHPS • Ideal for use as a front-end actuator thanks to its low dead weight • Controller-free actuation using digital signals • Gripping force (4 settings) adjustable via ratchet switch or via IO-Link® interface • RA1 version with robot connection, enables fast integration in lightweight robot environments
online: →	hgpp	hgpt	ehps

Mechanical grippers >



Three-point grippers

	 Three-point grippers DHDS	 Three-point grippers HGDD	 Three-point grippers HGDT
Size	16, 32, 50	35, 40, 50, 63, 80	25, 35, 40, 50, 63
Stroke per gripper jaw	2.5 ... 6 mm	4 ... 12 mm	1.5 ... 10 mm
Total gripping force at 0.6 MPa (6 bar, 87 psi), closing	87 ... 750 N	336 ... 2745 N	207 ... 2592 N
Gripping force backup	During closing	During opening, During closing	During opening, During closing
Gripper repetition accuracy	0.04 mm	0.03 mm, 0.05 mm	0.03 mm
Position sensing	Via Hall sensor, Via proximity switch	Via proximity switch	Via proximity switch
Description	<ul style="list-style-type: none"> Sturdy and precise T-slot guidance of the gripper jaws High gripping force and compact size Max. repetition accuracy Can be used as a double- and single-acting gripper Single-acting variant or with gripping force backup, normally closed (NC) Suitable for external and internal gripping Wide range of adaptation options on the drives 	<ul style="list-style-type: none"> Precise gripping with centric movements despite high torque loads Ideal for very harsh environments 5 sizes with stroke/jaw of up to 12 mm Can be used as a double- and single-acting gripper Single-acting variant or with gripping force backup, normally open (NO) or normally closed (NC) Suitable for external and internal gripping 	<ul style="list-style-type: none"> Synchronous movement of the gripper jaws Gripper jaw guide protected by sealing air against dust High-force variant available With T-slot guide Can be used as a double- and single-acting gripper Single-acting variant or with gripping force backup, normally open (NO) or normally closed (NC) Suitable for external and internal gripping
online: →	dhds	hgdd	hgdt

Product overview



Mechanical grippers >

Angle grippers

	 Angle gripper DHWC	 Angle grippers DHWS	 Angle grippers HGWM
Size	6, 10, 16, 20, 25, 32	10, 16, 25, 32, 40	8, 12
Total gripping torque at 0.6 MPa (6 bar, 87 psi), closing	5.4 ... 578.6 Ncm	30 ... 1362 Ncm	22 ... 64 Ncm
Max. opening angle	30 deg	40 deg	14 ... 18.5 deg
Gripping force backup	During opening, None	During closing	
Gripper repetition accuracy	0.1 mm	0.04 mm	0.02 mm
Position sensing	Via proximity switch	Via Hall sensor, Via proximity switch	Without
NEW	<ul style="list-style-type: none"> New product, 07/2021 		
Description	<ul style="list-style-type: none"> Lateral gripper jaw support for high torque loads Max. repetition accuracy Can be used as a double-acting or single-acting gripper Single-acting variant with gripping force backup, normally open (NO) Suitable for external and internal gripping Wide range of adaptation options on the drives 	<ul style="list-style-type: none"> Improved gripper jaw guide Internal fixed flow control, does away with the need for external flow control in 80% of applications Slotted guide Max. repetition accuracy Can be used as a double- and single-acting gripper Single-acting variant or with gripping force backup, normally closed (NC) Suitable for external and internal gripping Wide range of adaptation options on the drives 	<ul style="list-style-type: none"> Micro gripper: compact, handy design Versatile thanks to externally adaptable gripper fingers Single-acting gripper, optionally with open (NO) or closed (NC) gripper jaws Suitable for external and internal gripping Mounting options with clamping flange, with flange mounting, with Z-stroke compensation
online: →	dhwc	dhws	hgwm

Mechanical grippers >

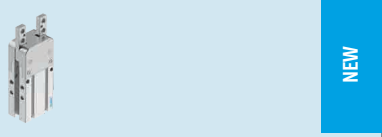
Radial grippers

	 Radial gripper DHRC	 Radial grippers DHRS	 Radial grippers HGRT
Size	6, 10, 16, 20, 25, 32	10, 16, 25, 32, 40	16, 20, 25, 32, 40, 50
Total gripping torque at 0.6 MPa (6 bar, 87 psi), closing	4.8 ... 600.1 Ncm	15 ... 660 Ncm	158 ... 7754 Ncm
Max. opening angle	180 deg	180 deg	180 deg
Gripping force backup	During opening, None	During closing	
Gripper repetition accuracy	0.1 mm	0.1 mm	0.02 mm
Position sensing	Via proximity switch	Via Hall sensor, Via proximity switch	Via proximity switch, Via inductive sensors
NEW	<ul style="list-style-type: none"> • New product, 07/2021 		
Description	<ul style="list-style-type: none"> • Lateral gripper jaw support for high torque loads • Can be used as a double-acting or single-acting gripper • Single-acting variant with gripping force backup, normally open (NO) • Suitable for external and internal gripping • Wide range of adaptation options on the drives 	<ul style="list-style-type: none"> • Lateral gripper jaw support for high torque loads • Self-centring • Internal fixed flow control • Max. repetition accuracy • Slotted guide • Can be used as a double- and single-acting gripper • Single-acting variant or with gripping force backup, normally closed (NC) • Wide range of adaptation options on the drives 	<ul style="list-style-type: none"> • Sturdy and precise kinematics for very high torque resistance and long service life • Secure gripping thanks to precise, polished plain-bearing guide • Slotted guide • Optimum cycle times thanks to freely adjustable opening angle up to a maximum of 90° per gripper finger. This prevents possible collisions due to the gripper jaws opening too far • Can be used as a double- and single-acting gripper • Single-acting variant or with gripping force backup, normally closed (NC) • Suitable for external and internal gripping • Wide range of adaptation options on the drives
online: →	dhrc	dhrs	hgrt

Mechanical grippers >



Swivel/gripper units

	 Swivel/gripper units HGDS
Size	12, 16, 20
Total gripping force at 0.6 MPa (6 bar, 87 psi), closing	74 ... 168 N
Stroke per gripper jaw	2.5 ... 7 mm
Swivel angle	210 deg
Position sensing, gripper	Via proximity switch
Description	<ul style="list-style-type: none"> • Combination of parallel gripper and swivel module • Swivel angle infinitely adjustable • Precise end stop with elastic cushioning or integrated shock absorber
online: →	hgds



Product overview

Bellows gripper

Bellows grippers

	 Adaptive shape gripper DHEF	 Bellows grippers DHEB
Size	20	8, 10, 12, 14, 18, 22, 27, 33, 41, 51, 63
Stroke	66 mm	
Bellows stroke		3.5 ... 25 mm
Max. operating frequency of gripper	1 Hz	≤4 Hz
Min. diameter to be gripped	12 mm	8 ... 66 mm
Max. diameter to be gripped	38 mm	11 ... 85 mm
Position sensing	Via proximity switch	Via proximity switch, Without
Description	<ul style="list-style-type: none"> Gripping of parts with undefined positions and shapes Form-fitting gripping of products with different geometries Form-fitting gripping with suction cup effect Gentle gripping of delicate products of varying sizes RA1 version with robot connection, enables fast integration in lightweight robot environments 	<ul style="list-style-type: none"> 11 sizes for gripping diameter from 8 to 85 mm Direction of movement: bellows upwards or downwards Different bellows materials: EPDM or silicone Air connection on the side or from above Optimised process sequence with increased quality: prevents the workpieces from being scratched Additional reliability: optional sensing via proximity or position sensor For gentle internal gripping of delicate workpieces
online: →	dhef	dheb

Accessories for grippers

	 Adaptive gripper fingers DHAS-GF	 Gripper jaw DHAS-GG
Size	60, 80, 120	16 mm
Description	<ul style="list-style-type: none"> Self-adapting to different workpiece shapes Adaptive gripper fingers for gentle and flexible gripping using the Fin Ray Effect® modelled on a fish's tail fin For workpiece diameters from 6 to 120 mm 	<ul style="list-style-type: none"> Process-reliable gripping, e.g. for microtiter plates in the life sciences sector Easy assembly
online: →	dhas	dhas



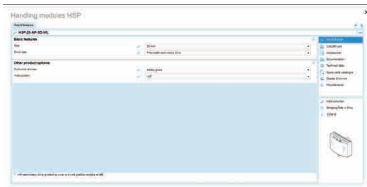

Product overview

Software tools

<p>Configurator</p> 	<p>Design a product with numerous features reliably and quickly with the help of the configurator.</p> <p>Select all the required product features step-by-step. The use of logic checks ensures that only correct configurations are available for selection.</p> <p>You will find the configurator for the required product</p> <ul style="list-style-type: none"> • at www.festo.com/catalogue/handling • Select the product you want • Click on the blue “Configure product” button
---	--

Pneumatic handling systems

		
	Handling modules HSP	Handling modules, pneumatic HSW-AP, HSW-AS
Size	12, 16, 25	10, 12, 16
Y-stroke	52 ... 170 mm	
Z-stroke	20 ... 70 mm	80 ... 100 mm
Repetition accuracy	+/-0.01 mm, +/-0.02 mm	
Min. cycle time	0.6 ... 1 s	0.6 ... 1 s
Theoretical force at 0.6 MPa (6 bar, 87 psi)	40 ... 65 N	30 ... 55 N
Description	<ul style="list-style-type: none"> • Function module for automatically repositioning, feeding and removing small parts in extremely confined spaces • Guided vertical and horizontal motion sequence • High precision and rigidity • Compact design • Extremely short cycle times • Cost-optimised • Stroke adjustment along Y- and Z-axes 	<ul style="list-style-type: none"> • Function module for automatically repositioning, feeding and removing small parts in extremely confined spaces • Guided swivel and linear motion • High precision and rigidity • HSW-AP: pneumatic, with swivel module DSM; HSW-AS: without drive, with drive shaft • Fast and compact • Low cost and ideal for universal use
online: →	hsp	hsw

Software tools

<p>Engineering tool: Handling Guide Online (HGO)</p> 	<p>Planning and designing complex handling systems, e.g. for pick & place applications, generally takes a lot of time.</p> <p>With the innovative Handling Guide Online (HGO) you can design a tailor-made system in just a few steps. Simply enter your application data such as the load mass, travel and cycle time.</p> <p>Benefits:</p> <ul style="list-style-type: none"> • 1D- ... 3D kinematics • Tailor-made system solution within just a few minutes • CAD model available immediately • Fully automatic selection of all relevant components • Fully automatic processing including ordering function • Fully assembled or unassembled systems <p>This tool can be found at → www.festo.com/x/handling-guide-online</p>
--	--



Cartesian robots >

Single-axis robots

 <p>Single-axis systems YXCS</p>	
<p>Description</p>	<ul style="list-style-type: none"> • Ready-to-install single-axis solution including energy chain for cables or tubing as well as suitable motor and servo drive package • For any single-axis movement • For horizontal mounting position • Based on the axis series EGC-TB (toothed belt axis) and EGC-HD-TB (toothed belt axis with heavy-duty guide) • High mechanical rigidity and sturdy design • Ideal for long gantry strokes and heavy loads
<p>online: →</p>	<p>yxcs</p>

Cartesian robots >



Linear gantries

 <p>Linear gantry, highly dynamic YXML</p>	 <p>Two-dimensional linear gantries YXCL</p>	 <p>Linear gantries EXCT</p>
<p>Description</p>	<ul style="list-style-type: none"> • Parallel kinematic drive concept for maximum dynamic response • Ready-to-install complete system including energy chain for cables or tubing as well as suitable motor and servo drive package • For two-dimensional movements in vertical working areas • Flexible working area due to scalable strokes in the Y and Z directions • Based on linear gantry EXCT • Maximum dynamic response and efficient operation up to mx. 95 picks/min. • For rapid processes with high cycle rates like pick & place, feeding parts, stacking, packaging tasks 	<ul style="list-style-type: none"> • Ready-to-install complete system including energy chain for cables or tubing as well as suitable motor and servo drive package • For two-dimensional movements in vertical working areas • Flexible working area due to scalable strokes in the Y and Z directions • Choice of vertical axis – pneumatic or electric • Y-axis based on the toothed belt axis EGC-TB and toothed belt axis with heavy-duty guide EGC-HD-TB. • Z-axis based on mini slide DGSL (pneumatic), EGSL (electromechanical) and spindle axis EGC-BS (electromechanical) • High mechanical rigidity and sturdy design • Ideal for long gantry strokes and heavy loads
<p>online: →</p>	<p>yxml</p>	<p>yxcl</p>

Product overview

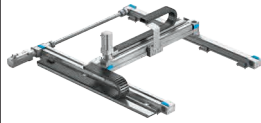

Cartesian robots >

Planar surface gantries

			
	Planar surface gantry, compact YXMF	Planar surface gantry, highly dynamic YXMF	Two-dimensional planar surface gantries YXCF
Description	<ul style="list-style-type: none"> • Parallel kinematic drive concept with minimal space requirements • Ready-to-install complete system including energy chain, suitable motors and dual servo drive • For two-dimensional movements in horizontal working areas • Flexible working area due to scalable strokes in the X and Y directions • Based on the planar surface gantry EXCM • For extremely small working areas • For desktop applications in small parts assembly, electronics manufacturing and laboratory processes 	<ul style="list-style-type: none"> • Parallel kinematic drive concept for maximum dynamic response • Ready-to-install complete system, including energy chain and suitable motor and servo drive package • For two-dimensional movements in horizontal working areas • Flexible working area due to scalable strokes in the X and Y directions • Based on the planar surface gantry EXCH • Maximum dynamic response and efficient operation up to max. 100 picks/min. • For rapid processes with high cycle rates like pick & place, feeding parts, stacking, packaging tasks • Cost-saving alternative to two Scara robots due to large working area and high dynamic response 	<ul style="list-style-type: none"> • Ready-to-install complete system including energy chain for cables or tubing as well as suitable motor and servo drive package • For two-dimensional movements in horizontal working areas • Flexible working area due to scalable strokes in the X and Y directions • X-axis based on toothed belt axis EGC-TB • Y-axis based on the toothed belt axis EGC-TB and toothed belt axis with heavy-duty guide EGC-HD-TB. • Especially suitable for very long strokes
online: →	yxmf	yxmf	yxcf



Cartesian robots >

Planar surface gantries

		
	Two-dimensional planar surface gantries EXCM	Two-dimensional planar surface gantries EXCH
Description	<ul style="list-style-type: none"> • Excellent functionality in small installation spaces • Low moving dead weight • Actuation via two stepper motors with an integrated optical encoder and a two-axis controller • With recirculating ball bearing guide • Sustainable operation due to weight-optimised axes 	<ul style="list-style-type: none"> • Optimal dynamic response when compared with other Cartesian gantry systems • Drive concept with low moving dead weight • Flat system design • High acceleration in both axial directions • Large working space • Sustainable operation due to weight-optimised axes
online: →	excm	exch

Cartesian robots >

Three-dimensional gantries

	 <p>Three-dimensional gantry, compact YXMR</p>	 <p>Three-dimensional gantry, highly dynamic YXMR</p>	 <p>Three-dimensional gantries YXCR</p>
Description	<ul style="list-style-type: none"> • Parallel kinematic drive concept with minimal space requirements • Ready-to-install complete system including energy chain, suitable motors and dual servo drive • For three-dimensional movements in horizontal working areas • Flexible working area due to scalable strokes in the X and Y directions • Based on the planar surface gantry EXCM • Choice of vertical axis – pneumatic or electric • For extremely small working areas • For desktop applications in small parts assembly, electronics manufacturing and laboratory processes 	<ul style="list-style-type: none"> • Parallel kinematic drive concept for maximum dynamic response • Ready-to-install complete system, including energy chain and suitable motor and servo drive package • For three-dimensional movements in horizontal working areas • Flexible working area due to scalable strokes in the X and Z directions • Based on the planar surface gantry EXCH • Maximum dynamic response and efficient operation up to max. 100 picks/min. • Choice of vertical axis – pneumatic or electric • For rapid processes and high cycle rates e.g. assembling, packaging and sorting 	<ul style="list-style-type: none"> • Ready-to-install complete system including energy chain for cables or tubing as well as suitable motor and servo drive package • For three-dimensional movements in vertical working areas • Flexible working area due to scalable strokes in the X, Y and Z directions • Choice of vertical axis – pneumatic or electric • X-axis based on toothed belt axis EGC-TB • Y-axis based on the toothed belt axis EGC-TB and toothed belt axis with heavy-duty guide EGC-HD-TB. • Z-axis based on mini slide DGSL (pneumatic), EGSL (electromechanical) and spindle axis EGC-BS (electromechanical) • High mechanical rigidity and sturdy design • For universal use • Especially suitable for long strokes in all directions
online: →	yxmr	yxmr	yxcr

	 <p>Cantilever system YXCA</p>
NEW	<ul style="list-style-type: none"> • New product, 11/2021
Description	<ul style="list-style-type: none"> • Extremely space-saving 3D system with attractive price-performance ratio • Axial or parallel motor connection freely selectable for optimum use of the installation space • Pneumatic and electric components can be freely combined • For horizontal installation position • For simple assembly tasks and small parts handling in the electronics industry • Ideal for use in line assembly processes or desktop applications
online: →	yxca

NEW

Product overview

Parallel kinematic system robots

	 <p>Parallel kinematic systems, tripod EXPT</p>
Maximum rated load	5 kg
Working space nominal diameter	950 ... 1200 mm
Working space nominal height	100 mm
Max. picking rate	140 picks/min in 12" cycle
Description	<ul style="list-style-type: none"> • Low moving mass – ideal for demanding requirements on dynamic response in three dimensions • High path accuracy with a range of path profiles, even for very dynamic operation • Optional rotary unit as 4th axis, on request with pneumatic rotary through-feed for vacuum or gauge pressure
online: →	expt

Control cabinets

	 <p>Control systems CMCB</p>
Design	Mounting plate, Control cabinet, Built-in safety relay unit
Electrical connection	Spring-loaded terminal, Push-in
Mains voltage AC	
Mains frequency	50 ... 60 Hz
Nominal operating voltage phases	
Performance level (PL)	Category B, Performance Level b, Category 3, Performance Level d
NEW	<ul style="list-style-type: none"> • New product, 11/2021
Description	<ul style="list-style-type: none"> • Ready-to-install control system • Available on a mounting plate with or without control cabinet housing • Variants with safety functions • Adapted for balancer kit YHBP • With connecting cables for balancer kit YHBP connected
online: →	cmcb

Customised components – for your specific requirements



Compact handling system for desktop applications

- Modular system kit comprising operating software and planar surface gantry EXCM-30
- Quick and easy programming and commissioning using the predefined function elements from the Positioning Desktop Lib
- One basic platform for a wide range of applications (screwing in, dispensing, testing, soldering, gripping, machine vision and much more)
- Predefined function elements from the software library make for easy programming and commissioning
- Easy integration, even in the most compact of installation spaces
- Fit for Industry 4.0 thanks to the OPC UA interface at the controller

Many additional variants are possible.

Ask your Festo sales engineer, who will be happy to help you:

→ www.festo.com/contact

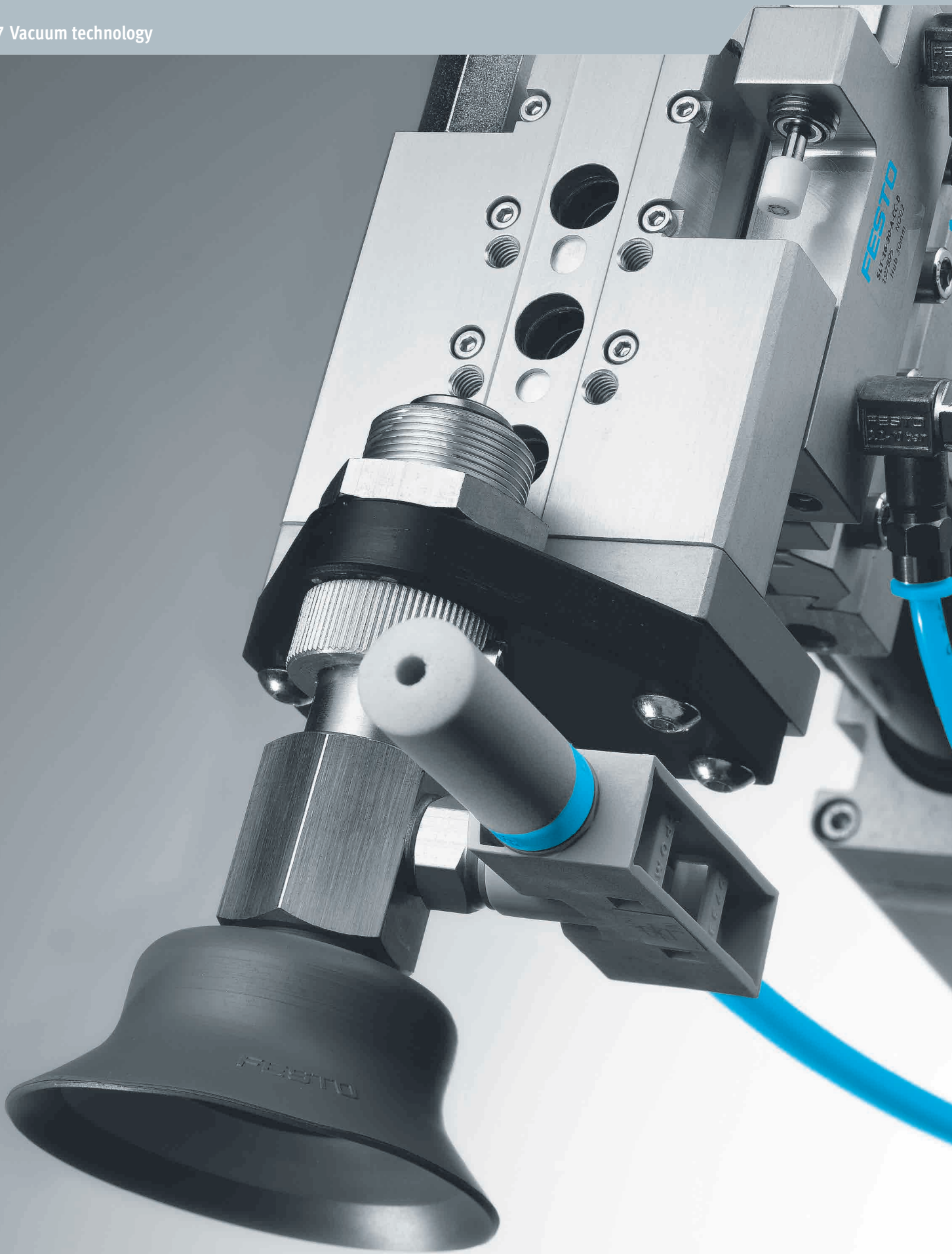



Product overview



Software tools

<p>Vacuum design</p> 	<p>Which suction cup is used for which surface and which movement? Don't experiment – calculate!</p> <p>The vacuum selection program helps you select the right suction cups, tubing and venturi nozzles. It also calculates the distribution of the forces acting on the individual suction cups, as well as the evacuation time.</p> <p>This software tool even enables a distinction to be made between linear and rotary movements.</p> <p>This tool can be found at → www.festo.com/x/vacuum-sizing</p>
--	--

Vacuum generators



	 Vacuum generators OVTL	 Vacuum generators OVEL	 Vacuum generators OVEM
Nominal width of Laval nozzle	0.45 ... 0.95 mm	0.45 ... 0.95 mm	0.45 ... 3 mm
Ejector characteristics	High suction rate, High vacuum, Standard	High suction rate, High vacuum, Standard	High suction rate, High vacuum, Standard
Integrated function	Electric ejector pulse, Flow control, Pressure sensor, Pressure transmitter, Electric on-off valve, Filter, Open silencer	Electric ejector pulse, Flow control, Pressure sensor, Pressure transmitter, Electric on-off valve, Filter, Open silencer, Silencer closed	Electric ejector pulse valve, Flow control, Electric on-off valve, Filter, Air saving function, electrical, Check valve, Open silencer, Vacuum switch
Max. vacuum			
Max. suction rate with respect to atmosphere	4 ... 45 l/min	4 ... 21 l/min	6 ... 348 l/min
Description	<ul style="list-style-type: none"> • Module consisting of vacuum generator OVEL, manifold rail and accessories • Select, size and order quickly, easily and reliably with the configurator • Supplied fully assembled 	<ul style="list-style-type: none"> • Low-cost, compact vacuum generator • Light weight • Various performance levels and vacuum types • Short switching times thanks to integrated solenoid valves • Quick, precise and safe placement of the workpiece via the ejector pulse • Easy assembly • Minimal installation costs • Sustainable operation thanks to reduced pressure level • RA1 version with robot connection, enables fast integration in lightweight robot environments 	<ul style="list-style-type: none"> • Compact design • Monitoring with vacuum sensor with IO-Link® • Central electrical connection via an M12 plug • Maintenance-free operation and reduced noise level through an integrated, open silencer • Integrated filter with inspection window • Optionally with air-saving function and LCD display • Short switching times thanks to integrated solenoid valves • Adjustable ejector pulse: precise and safe depositing of the workpiece • Sustainable operation with air-saving circuit
online: →	ovtl	ovel	ovem

Vacuum generators



	 Vacuum generators, pneumatic VN ★	 Vacuum generators, electropneumatic VN ★	 Vacuum generator cartridges VN
Nominal width of Laval nozzle	0.45 ... 3 mm	0.45 ... 3 mm	0.45 ... 2 mm
Ejector characteristics	High suction rate, High vacuum, Standard, Inline, High negative pressure, High suction volume	Standard, High negative pressure, High suction volume	Standard, High negative pressure, High suction volume
Integrated function	Ejector pulse valve, pneumatic, Open silencer, Vacuum switch	Ejector pulse valve, pneumatic, Electric on-off valve, Open silencer	
Max. vacuum			
Max. suction rate with respect to atmosphere	6.1 ... 339 l/min	7.2 ... 186 l/min	7.2 ... 184.4 l/min
Description	<ul style="list-style-type: none"> • Can be used directly in the work space • Available as straight type (in-line: vacuum port in line with the supply port) or T-shape (standard: vacuum port at 90° to the supply port) • Compact and cost-effective • Maintenance-free operation and reduced noise level through an integrated, open silencer 	<ul style="list-style-type: none"> • Can be used directly in the work space • Low cost • Maintenance-free operation and reduced noise level through an integrated, open silencer • With solenoid valve vacuum on/off 	<ul style="list-style-type: none"> • For fitting into customised housing for decentralised vacuum generation
online: →	vn	vn	vn

Product overview

Suction cup with connection

	 Suction cup OGVM	 Bernoulli grippers OGGB	 Suction grippers ESG
Suction cup size	16x55 mm, 20x65 mm, 30x65 mm, 30x80 mm, 30x95 mm, 40x85 mm, 40x90 mm, 50x105 mm, 55x115 mm, 60x125 mm, 70x145 mm, 20x60 mm		4x20 mm, 6x10 mm, 6x20 mm, 8x20 mm, 8x30 mm, 4x10 mm, 10x30 mm, 15x45 mm, 20x60 mm, 25x75 mm, 30x90 mm
Gripper diameter		60 ... 140 mm	
Suction cup diameter	20 ... 125 mm		2 ... 200 mm
Holding force at nominal operating pressure	15 ... 630 N	6 ... 10 N	
Design			Vacuum port on top, Vacuum port on side, With height compensator, With long height compensator
Information on suction cup materials	HNBR, NBR		BR, FPM, NBR, PUR, VMQ (silicone), Vulkollan
Spacer material		NBR, POM	
Description	<ul style="list-style-type: none"> Extremely energy efficient, very high transverse forces, minimal suction times Optimum suction ergonomics for maximum process reliability Ideal for workpieces with complex contours Accessories available for a wide range of applications 	<ul style="list-style-type: none"> Ideally suited to transporting thin, extremely delicate and brittle workpieces Minimised workpiece contact, gentle workpiece handling Low energy costs thanks to minimised air consumption The ideal solution for low-contact gripping and for gripping pliable, porous and brittle workpieces 	<ul style="list-style-type: none"> Modular system of suction cup holders and suction cups with over 5000 variants Optionally with angle compensator, height compensator, filter 15 suction cup diameters 6 suction cup shapes Suction cup volume: 0.002 ... 245 cm³ Min. workpiece radius: 10 ... 680 mm Vacuum connection: push-in connector or barbed fitting for plastic tubing, threaded connection
online: →	ogvm	oggb	esg

Suction cup with connection

	 Suction cups ESS	 Suction cups ESV	 Suction cups VAS, VASB ★
Suction cup size	4x20 mm, 6x10 mm, 6x20 mm, 8x20 mm, 8x30 mm, 4x10 mm, 10x30 mm, 15x45 mm, 20x60 mm, 25x75 mm, 30x90 mm		
Gripper diameter			
Suction cup diameter	2 ... 200 mm	20 ... 200 mm	2 ... 125 mm
Holding force at nominal operating pressure	0.1 ... 1610 N	8.2 ... 1610 N	0.14 ... 700 N
Design	Round, bell-shaped	Bellows, Round, bell-shaped	
Information on suction cup materials	BR, FPM, NBR, PUR, VMQ (silicone), Vulkollan	BR, FPM, NBR, PUR, VMQ (silicone), Vulkollan	NBR, PUR, TPE-U(PU), VMQ (silicone)
Spacer material			
Description	<ul style="list-style-type: none"> • Suction cup consisting of the suction cup itself, plus the support plate with mounting • Suction cup volume: 0.002 ... 245 cm³ • Min. workpiece radius: 10 ... 680 mm • Mounting for suction cup holder: female thread, male thread, push-in connector • Suction cup with mounting thread 	<ul style="list-style-type: none"> • Wearing part for suction cup • Easily interchangeable • Suction cup volume: 0.318 ... 245 cm³ • Min. workpiece radius: 10 ... 680 mm 	<ul style="list-style-type: none"> • Sturdy and reliable • Suction cups with fixed connecting thread • 11 suction cup diameters • Round suction cup, bellows • Vacuum connection on top, on side • Screw-in thread
online: →	ess	esv	vas

Accessories for vacuum >





Assembly and connecting components

	 Suction cup holders ESH
Design	Vacuum port on top, Vacuum port on side, With height compensator
Description	<ul style="list-style-type: none"> • With or without height compensator • 6 holder sizes • 8 holder types • 3 different types of vacuum connections: push-in connection, barbed fitting, threaded connection
online: →	esh

Product overview



Accessories for vacuum >

Vacuum-specific accessories

	 Length compensator VAL	 Angle compensators ESWA	 Vacuum gauges VAM, FVAM	 Vacuum filters ESF, VAF, OAFF
Vacuum connection	M5, G1/8, G1/4			M4, M6, G1/4, G3/8, G1/2
Pneumatic connection		M10, M4, M6	G1/4, G1/8, R1/4, R1/8	G1/2, G1/4, G3/8, M4, M6, PK-3 Via union nut, PK-4 Via union nut, PK-6 Via union nut
Type of mounting	With male thread M16x1, With male thread M22x1.5, With male thread M26x1.5	Via male thread	Front panel mounting, Screw-in	In-line installation, Push-on, Snapping in, Via male thread, Via wall/surface bracket, Via vacuum port
Grade of filtration				10 µm, 40 µm, 50 µm, 80 µm
Description	<ul style="list-style-type: none"> For suction cup VAS/VASB Vacuum port M5, G1/8, G1/4 To compensate for a possible excess stroke of the handling device To compensate for tolerance differences in the workpiece thickness 	<ul style="list-style-type: none"> For suction gripper ESG Vacuum port M4x0.7, M6x1, M10x1.5 For mounting between suction cup holder and suction cup 	<ul style="list-style-type: none"> Designs based on DIN EN 837-1, available with red-green range Pneumatic connection via R or G thread Double or single scale Display units bar, in Hg, psi 	<ul style="list-style-type: none"> Vacuum filter ESF: for suction gripper ESG Vacuum filter VAF: with transparent housing or bowl to allow users to assess contamination level Vacuum filter OAFF: for vacuum generators OVEL
online: →	val	eswa	vam	vaf

Accessories for vacuum >

Vacuum-specific accessories

	 Vacuum security valves ISV	 Silencers UO	 Silencers UOM, UOMS
Vacuum connection			
Pneumatic connection		G1/4, G1/8, M5, M7	G1/4, G3/8
Type of mounting	Screw-in		Snapping in, Screw-in
Grade of filtration			
Description	<ul style="list-style-type: none"> For maintaining the vacuum when using multiple suction cups and one fails Gripping of randomly placed products Saves compressed air and energy 	<ul style="list-style-type: none"> Special open minimal resistance silencer For vacuum generators Facilitates trouble-free operation of the vacuum generator Operating medium compressed air 	<ul style="list-style-type: none"> Special open minimal resistance silencer For vacuum generators Facilitates trouble-free operation of the vacuum generator Silencer extension for extending the silencer for further noise reduction Operating medium compressed air
online: →	isv	uo	uom

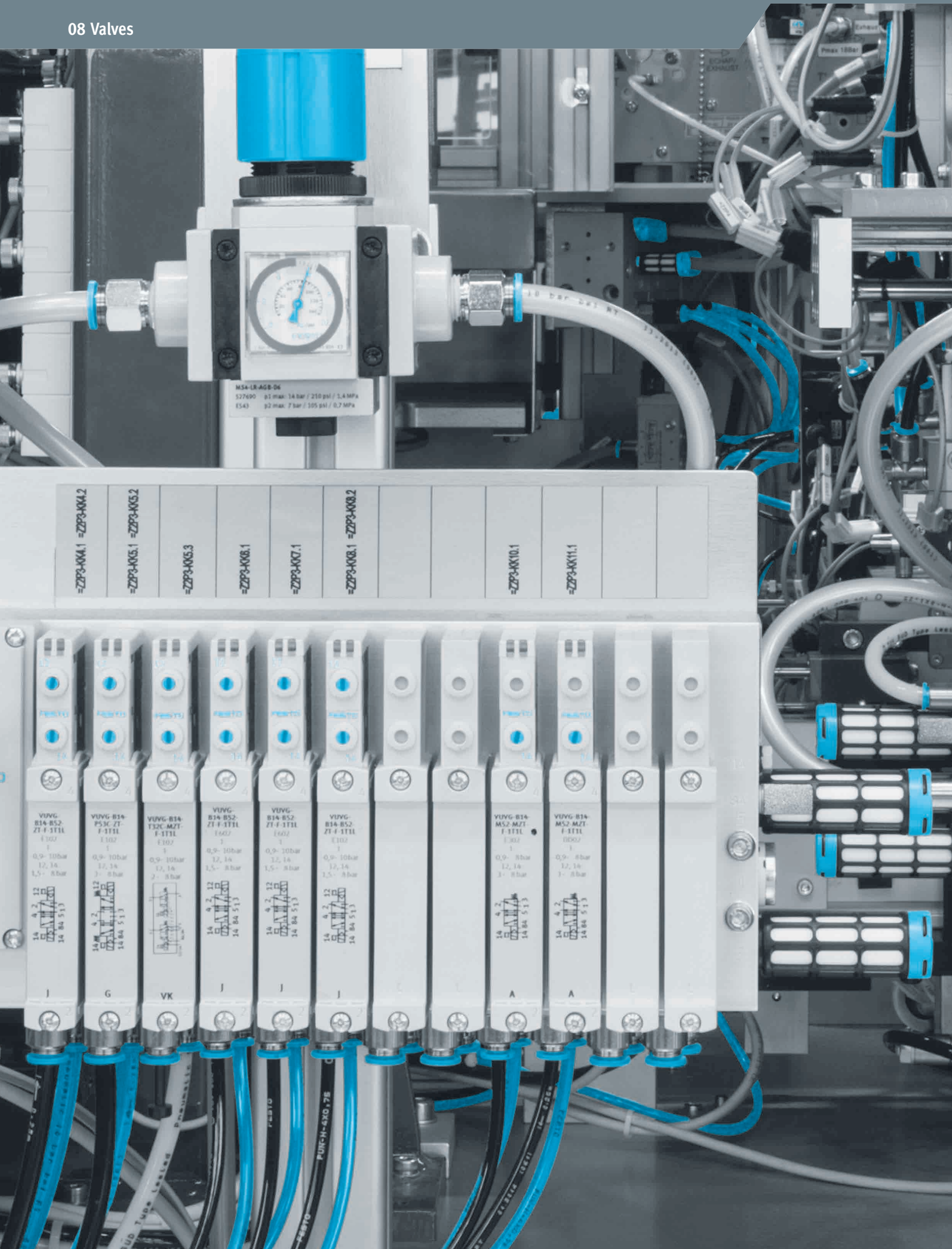

Product overview

Software tools

Pneumatic dimensioning

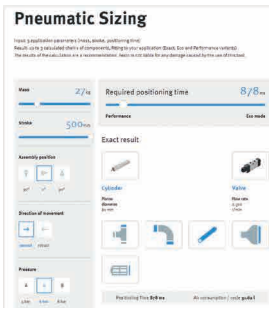

Dimension pneumatic control chains quickly and energy-efficiently.

In order to survive in the tough competitive environment, many companies are looking for potential savings in their production.





They also find these in their compressed air systems and plants, most of which have been in place for years. Up to 60% energy costs can be saved here through optimisation at hall and plant level.

This tool can be found at

➔ www.festo.com/x/pneumatic-sizing

Electrically and pneumatically actuated directional control valves >

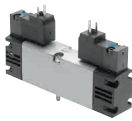

Standards-based directional control valves

	 Solenoid valves VSNC	 Standards-based valves with central plug VSVA-R5, VSVA-R2	 Standards-based valves with individual plug VSVA-C1, VSVA-P1	 Standards-based valves, plug-in VSVA-T1
Actuation type	Electric	Electric	Electric	Electric
Pneumatic connection 1	1/4 NPT, G1/4, QS-1/4, QS-10, QS-3/8, QS-5/16, QS-6, QS-8	Sub-base Size 1 ISO 5599-1, Size 2 ISO 5599-1	Sub-base Size 18 mm ISO 15407-1, Size 26 mm ISO 15407-1	Sub-base Size 1 ISO 5599-2, Size 2 ISO 5599-2, Size 18 mm ISO 15407-2, Size 26 mm ISO 15407-2
Operating pressure [MPa]		-0.09 ... 1.6 MPa	-0.09 ... 1.6 MPa	-0.09 ... 1 MPa
Operating pressure	1.5 ... 10 bar	-0.9 ... 16 bar	-0.9 ... 16 bar	-0.9 ... 10 bar
Standard nominal flow rate	800 ... 1350 l/min	400 ... 2800 l/min	400 ... 1400 l/min	125 ... 2900 l/min
Valve function	5/2 double solenoid, 5/2-way or 3/2-way, convertible, 5/3-way, pressurised, 5/3 exhausted, 5/3 closed	2x2/2-way, monostable, closed, 2x3/2-way, monostable, closed, 2x3/2-way, open, monostable, 2x3/2-way, open/closed, monostable, 5/2 double solenoid, 5/2-way, bistable, dominant, 5/2-way, monostable, 5/3-way, pressurised, 5/3 exhausted, 5/3 closed	2x2/2-way, monostable, closed, 2x3/2-way, monostable, closed, 2x3/2-way, open, monostable, 2x3/2-way, open/closed, monostable, 5/2 double solenoid, 5/2-way, bistable, dominant, 5/2-way, monostable, 5/3-way, pressurised, 5/3 exhausted, 5/3 closed	2x2/2-way, monostable, closed, 2x3/2-way, monostable, closed, 2x3/2-way, open, monostable, 2x3/2-way, open/closed, monostable, 3/2-way, closed, monostable, 5/2 double solenoid, 5/2-way, bistable, dominant, 5/2-way, monostable, 5/3-way, pressurised 1 to 2, 4 to 5 closed, 5/3-way, pressurised, 5/3 exhausted, 5/3 closed, 5/3-way, port 2 pressurised, 4 exhausted, 5/3-way, port 4 pressurised, 2 exhausted
Electrical connection	3-pin, Type A, Type B, Cable connector M20x1.5, Plugs, To EN 175301-803, To industry standard (11 mm)	3-pin, 4-pin, Central plug, Round design, M8x1, M12x1	Type C, With protective earth conductor, To DIN EN 175301-803, To EN 175301-803, Without protective earth conductor	2-pin, 4-pin, Plug-in, Plugs, To ISO 15407-2, To ISO 5599-2
Description	<ul style="list-style-type: none"> Namur connection pattern to VDI/VDE 3845 Rotatable seal for 3/2- or 5/2-way valve Wide choice of EX solenoid systems Sturdy and powerful Extended temperature range Excellent value for money All solenoid coils can be used on an armature tube The VSNC...FN variant achieves greater energy efficiency with reduced power consumption 	<ul style="list-style-type: none"> Conforms to ISO 5599-1 Electrical connection with central plug Robust metal housing Manifold assembly with mixed sizes possible 	<ul style="list-style-type: none"> Corresponds to ISO 15407-1 and to ISO 15218 for pilot valve with interface Electrical connection via plug type C Robust metal housing Manifold assembly with mixed sizes possible 	<ul style="list-style-type: none"> For valve terminal VTSA/VTSA-F Robust metal housing
online: →	VSNC	VSVA	VSVA	VSVA

Product overview



Electrically and pneumatically actuated directional control valves >

Standards-based directional control valves

			
	Pneumatic valves to ISO 15407-1 VSPA	Solenoid valves to ISO 5599-1 MN1H, MFH, MDH, MEBH, JMN1H, JMN1DH, JMFH, JMFDH, JMDH, JMEBH, JMEBDH, JMDDH	Pneumatic valves to ISO 5599-1 VL, J, JD
Actuation type	Pneumatic	Electric	Pneumatic
Pneumatic connection 1	Sub-base Size 18 mm ISO 15407-1, Size 26 mm ISO 15407-1	Sub-base Size 1 ISO 5599-1, Size 2 ISO 5599-1, Size 3 ISO 5599-1, Size 4 ISO 5599-1	Sub-base Size 1 ISO 5599-1, Size 2 ISO 5599-1, Size 3 ISO 5599-1, Size 4 ISO 5599-1
Operating pressure [MPa]			
Operating pressure	-0.9 ... 16 bar	-0.9 ... 16 bar	-0.9 ... 16 bar
Standard nominal flow rate	400 ... 1100 l/min	1200 ... 6000 l/min	1200 ... 6000 l/min
Valve function	2x3/2-way, monostable, closed, 2x3/2-way, open, monostable, 2x3/2-way, open/closed, monostable, 5/2 double solenoid, 5/2-way, bistable, dominant, 5/2-way, monostable, 5/3-way, pressurised, 5/3 exhausted, 5/3 closed	5/2 double solenoid, 5/2-way, bistable, dominant, 5/2-way, monostable, 5/3-way, pressurised, 5/3 exhausted, 5/3 closed	5/2 double solenoid, 5/2-way, bistable, dominant, 5/2-way, monostable, 5/3-way, pressurised, 5/3 exhausted, 5/3 closed
Electrical connection		Central plug, To DIN EN 175301-803, Round design, Via F coil, to be ordered separately, Via N1 coil, to be ordered separately, M12x1	
Description	<ul style="list-style-type: none"> • Conforms to ISO 15407-1 • Pneumatic control • Manifold assembly with mixed sizes possible 	<ul style="list-style-type: none"> • Conforms to ISO 5599-1 • Robust metal housing • Manifold assembly with mixture of ISO sizes 1, 2 and 3 possible • Extensive range of electrical connection options • Wide range of vertical stacking modules: pressure regulator, flow control valve, vertical pressure shut-off plate, etc. • Also available as a valve terminal 	<ul style="list-style-type: none"> • Conforms to ISO 5599-1 • Pneumatic control
online: →	vspa	iso 5599-1	iso 5599-1





Electrically and pneumatically actuated directional control valves >

Standards-based directional control valves

		
	Standards-based valves to ISO 15218 (CNOMO) MDH, MGXDH, MGXIAH, VSCS	Standards-based valves, NAMUR (VDI/VDE 3845) NVF3
Actuation type	Electric	Electric
Pneumatic connection 1	Sub-base	G1/4
Operating pressure [MPa]	-0.09 ... 1.6 MPa	0.2 ... 1 MPa
Operating pressure	-0.9 ... 16 bar	2 ... 10 bar
Standard nominal flow rate	13.5 ... 50 l/min	900 l/min
Valve function	3/2-way, closed, monostable	5/2- or 3/2-way monostable
Electrical connection	Type A, Type C, To DIN EN 175301-803, To IEC 61076-2-101, M12x1	
Description	<ul style="list-style-type: none"> • CNOMO connection pattern, to ISO 15218 • With or without manual override 	<ul style="list-style-type: none"> • Namur connection pattern to VDI/VDE 3845 • Electrically actuated, piloted • Reset via mechanical return • Variants to EU Explosion Protection Directive (ATEX)
online: →	iso 15218	namur

Electrically and pneumatically actuated directional control valves >



Universal directional control valves

	 Solenoid valves, for individual connection VUVG ★	 Solenoid valves, plug-in VUVG-T1	 Solenoid valves, plug-in VUVG-T1-FA1 ★	 Pneumatic valves VUWG
Actuation type	Electric	Electric	Electric	Pneumatic
Pneumatic connection 1	G1/4, G1/8, M3, M5, M7			G1/4, G1/8, M3, M5, M7
Pneumatic working port	G1/4, G1/8, M3, M5, M7, QS-1/4, QS-1/8, QS-10, QS-3, QS-3/16, QS-3/8, QS-4, QS-5/16, QS-5/32, QS-6, QS-8	Flange, G1/4, G1/8, M5, M7	Flange	G1/4, G1/8, M3, M5, M7, QS-1/4, QS-1/8, QS-10, QS-3, QS-3/16, QS-3/8, QS-4, QS-5/16, QS-5/32, QS-6, QS-8
Operating pressure [MPa]	-0.09 ... 1 MPa	-0.09 ... 1 MPa	-0.09 ... 1 MPa	
Operating pressure	-0.9 ... 10 bar	-0.9 ... 10 bar	-0.9 ... 10 bar	-0.9 ... 10 bar
Standard nominal flow rate	80 ... 1380 l/min	130 ... 1200 l/min	130 ... 510 l/min	80 ... 1380 l/min
Valve function	2x3/2-way, monostable, closed, 2x3/2-way, open, monostable, 2x3/2-way, open/closed, monostable, 5/2 double solenoid, 5/2-way, monostable, 5/3-way, pressurised, 5/3 exhausted, 5/3 closed	2x3/2-way, monostable, closed, 2x3/2-way, open, monostable, 2x3/2-way, open/closed, monostable, 3/2-way, closed, monostable, 3/2 open, single solenoid, 5/2 double solenoid, 5/2-way, monostable, 5/3-way, pressurised, 5/3 exhausted, 5/3 closed	2x3/2-way, monostable, closed, 2x3/2-way, open, monostable, 2x3/2-way, open/closed, monostable, 5/2 double solenoid, 5/2-way, monostable, 5/3-way, pressurised, 5/3 exhausted, 5/3 closed	2x3/2-way, monostable, closed, 2x3/2-way, open, monostable, 2x3/2-way, open/closed, monostable, 5/2 double solenoid, 5/2-way, monostable, 5/3-way, pressurised, 5/3 exhausted, 5/3 closed
Electrical connection	2-pin, 3-pin, Plug pattern H, horizontal connection, M8x1, A-coded, to EN 61076-2-104, Plugs, Via electrical sub-base, Via electric pilot valve	Via sub-base	Via sub-base	
Description	<ul style="list-style-type: none"> • Compact universal valve • Connection technology via electrical connection box (E-box) • High flow rate relative to its size • In-line valves can be used as individual valves or manifold valves 	<ul style="list-style-type: none"> • Sub-base valve, semi in-line valve • For valve terminal VTUG with multi-pin, fieldbus interface • Variants to EU Explosion Protection Directive (ATEX) 	<ul style="list-style-type: none"> • Sub-base valve • For valve terminal VTUG with multi-pin, fieldbus interface • Recommended for production systems for manufacturing lithium-ion batteries 	<ul style="list-style-type: none"> • Compact universal valve • Pneumatically actuated • High flow rate relative to its size • In-line valves can be used as individual valves or manifold valves • Can be combined on manifold rail with electric individual valves
online: →	vuvg	vuvg	vuvg	vuwg

Product overview



Electrically and pneumatically actuated directional control valves >

Universal directional control valves

	 Solenoid valves VUVS	 Pneumatic valves VUWS	 Solenoid valves VMPA1, VMPA14, VMPA2
Actuation type	Electric	Pneumatic	Electric
Pneumatic connection 1	1/8 NPT, G1/4, G1/8, G3/8	G1/4, G1/8, G3/8	G1/8, M7
Pneumatic working port	1/8 NPT, 1/4 NPT, 3/8 NPT, G1/4, G1/8, G3/8, QS-1/2, QS-1/4, QS-10, QS-12, QS-3/8, QS-4, QS-5/16, QS-5/32, QS-6, QS-8	1/8 NPT, 1/4 NPT, 3/8 NPT, G1/4, G1/8, G3/8, QS-1/4, QS-10, QS-3/8, QS-4, QS-5/16, QS-5/32, QS-6, QS-8	G1/8, M7
Operating pressure [MPa]	-0.09 ... 1 MPa	-0.09 ... 1 MPa	-0.09 ... 1 MPa
Operating pressure	-0.9 ... 10 bar	-0.9 ... 10 bar	-0.9 ... 10 bar
Standard nominal flow rate	500 ... 2400 l/min	500 ... 2400 l/min	140 ... 870 l/min
Valve function	2x3/2-way, monostable, closed, 2x3/2-way, open, monostable, 2x3/2-way, open/closed, monostable, 3/2-way, closed, monostable, 3/2 open, single solenoid, 5/2 double solenoid, 5/2-way, monostable, 5/3-way, pressurised, 5/3 exhausted, 5/3 closed	2x3/2-way, monostable, closed, 2x3/2-way, open, monostable, 2x3/2-way, open/closed, monostable, 3/2-way, closed, monostable, 3/2 open, single solenoid, 5/2 double solenoid, 5/2-way, monostable, 5/3-way, pressurised, 5/3 exhausted, 5/3 closed	2x2/2-way, monostable, closed, 2x3/2-way, monostable, closed, 2x3/2-way, open, monostable, 2x3/2-way, open/closed, monostable, 3/2-way, closed, monostable, 3/2 open, single solenoid, 5/2 double solenoid, 5/2-way, monostable, 5/3-way, pressurised, 5/3 exhausted, 5/3 closed
Electrical connection	Type B, Type C, To EN 175301-803, To industry standard (11 mm)		4-pin, Plugs, To EN 60947-5-2, M8x1
Description	<ul style="list-style-type: none"> • Universal valve, sturdy and durable • Low cost with no performance limitations • Can be used as individual valves or manifold valves VTUS 	<ul style="list-style-type: none"> • Universal valve, sturdy and durable • Pneumatically actuated • Can be used as individual valves or manifold valves VTUS 	<ul style="list-style-type: none"> • For valve terminal MPA • As individual valve mounted on sub-base • Comprehensive range of valves
online: →	vuvs	vuws	vmpa1

Electrically and pneumatically actuated directional control valves >





Universal directional control valves

			
	Solenoid valves, Tiger 2000 MFH	Solenoid and pneumatic valves, Tiger Classic MFH, MOFH, JMFH, JMFDH, VL/O, VL, JH, JDH	Solenoid valves, supplementary product range BMCH, BMFH, JMC, JMF, MC, MCH, MF, MFH, MOCH, MOFH
Actuation type	Electric	Electric, Pneumatic	Electric
Pneumatic connection 1	G3/8	G1/2, G1/4, G1/8, G3/4	G1/4, G1/8, M5
Pneumatic working port	G3/8	G1/2, G1/4, G1/8, G3/4	G1/8, M5
Operating pressure [MPa]	-0.09 ... 1 MPa	-0.095 ... 1 MPa	-0.095 ... 0.8 MPa
Operating pressure	-0.9 ... 10 bar	-0.95 ... 10 bar	-0.95 ... 8 bar
Standard nominal flow rate	2000 ... 2600 l/min	500 ... 7500 l/min	46 ... 300 l/min
Valve function	5/2-way, monostable, 5/3-way, pressurised	3/2-way, closed, monostable, 3/2 open, single solenoid, 3/2-way, monostable, open/closed, 5/2 double solenoid, 5/2-way, bistable, dominant, 5/2-way, monostable	2/2-way, closed, monostable, 2x3/2-way, monostable, closed, 3/2-way, closed, monostable, 3/2 open, single solenoid, 3x3/2-way, monostable, closed
Electrical connection	Via F coil, to be ordered separately	Via F coil, to be ordered separately	Plugs
Description	<ul style="list-style-type: none"> • Sturdy and reliable • Wide range of voltages thanks to individual coils • Principle with armature tube • To EU Explosion Protection Directive (ATEX) 	<ul style="list-style-type: none"> • Sturdy and reliable • Poppet valve • All-metal version • Principle with armature tube 	<ul style="list-style-type: none"> • Manifold mounting or individual valve • Valves for special applications • With or without manual override
online: →	tiger 2000	tiger classic	bmch

Product overview

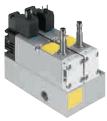



Electrically and pneumatically actuated directional control valves >

Application-specific directional control valves

	 Control blocks VOFA	 Solenoid valves VOFD	 Solenoid valves VOFC	 Solenoid valves VOVG
Design	Piston gate valve	Directly actuated poppet valve	Piston gate valve, Piloted piston poppet valve	Piston gate valve
Valve function	3/2-way, closed, monostable, 5/2-way, monostable	3/2-way, closed, monostable, semi-automatic, 3/2-way, closed, monostable	3/2-way, closed, monostable, 5/2 double solenoid, 5/2-way, monostable	3/2-way, closed, monostable, 3/2 open, single solenoid, 5/2-way, monostable
Operating pressure [MPa]	0.3 ... 1 MPa	0 ... 1.2 MPa	0 ... 1 MPa	-0.09 ... 0.8 MPa
Operating pressure	3 ... 10 bar	0 ... 12 bar	0 ... 10 bar	-0.9 ... 8 bar
Ambient temperature	-5 ... 50°C	-50 ... 60°C	-25 ... 60°C	-5 ... 50°C
Pneumatic connection 1	G1/4	1/4 NPT, NAMUR port pattern, G1/4, G1/2, 1/2 NPT	1/4 NPT, 1/2 NPT, NAMUR port pattern, G1/2, G1/4, M5	Sub-base, M5, M7
Standard nominal flow rate	950 ... 1050 l/min	52 ... 1900 l/min	595 ... 2794 l/min	180 ... 200 l/min
Safety integrity level (SIL)		Up to SIL 3 High Demand mode, To SIL 3 Low Demand mode	Up to SIL 2 High Demand mode, To SIL 2 Low Demand mode, Up to SIL 3 High Demand mode, To SIL 3 Low Demand mode	
Performance level (PL)	Exhausting/up to category 4, performance level e, Protection against manipulation, prevention of unexpected start-up/up to category 4, Performance Level e, Reversing a movement/up to category 4, Performance Level e			
Description	<ul style="list-style-type: none"> • Redundantly designed valve block, can be used for safe reversing of a hazardous movement • Can be selected as a decentralised individual connection variant with electrical and pneumatic individual connection or as a feature integrated in the valve terminal VTSA/VTSA-F • Equipped with valves VSVA • Switching position sensing by sensors • With safety functions • Suitable for use as a press safety valve to EN 692 	<ul style="list-style-type: none"> • Suitable for process automation in the chemical and petrochemical industries • Suitable for outdoor use under harsh ambient conditions • Especially suitable for quarter turn actuators thanks to NAMUR flange pattern • Variants with safety functions • Variants to EU Explosion Protection Directive (ATEX) 	<ul style="list-style-type: none"> • Suitable for process automation in the chemical and petrochemical industries • Suitable for outdoor use under harsh ambient conditions • Especially suitable for quarter turn actuators thanks to NAMUR flange pattern • Valve can switch between internal and external pilot air • Variants with safety functions • Variants to EU Explosion Protection Directive (ATEX) 	<ul style="list-style-type: none"> • Very compact valve for solutions with high component density • Suitable for applications in the electronics and light assembly industry • In-line, semi in-line and sub-base valve • Manifold rail for 2 ... 10 valves
online: →	vofa	vofd	vofc	vofg

Electrically and pneumatically actuated directional control valves >



Application-specific directional control valves

				
	Solenoid valves MHA1, MHP1	Solenoid valves MHE2, MHP2, MHA2, MHE3, MHP3, MHA3, MHE4, MHP4, MHA4	Solenoid valves CDVI5.0	Fast-switching valves MHJ9, MHJ10
Design	Poppet valve with spring return	Pressure-relieved poppet valve	Piston gate valve	Poppet valve without spring return
Valve function	2/2-way, closed, monostable, 2x2/2-way, monostable, closed, 3/2-way, closed, monostable, 3/2 open, single solenoid	3/2-way, closed, monostable, 3/2 open, single solenoid, 5/2-way, monostable	2/2-way, closed, monostable, 2/2 open, single solenoid, 2x3/2-way, monostable, closed, 2x3/2-way, open, monostable, 3/2-way, closed, monostable, 3/2 open, single solenoid, 5/2 double solenoid, 5/2-way, monostable, 5/3-way, pressurised, 5/3 exhausted, 5/3 closed	2/2-way, closed, monostable
Operating pressure [MPa]		-0.09 ... 0.8 MPa		0.05 ... 0.8 MPa
Operating pressure	-0.9 ... 8 bar	-0.9 ... 8 bar	-0.9 ... 10 bar	0.5 ... 8 bar
Ambient temperature	-5 ... 50°C	-5 ... 60°C	-5 ... 50°C	-5 ... 60°C
Pneumatic connection 1	Sub-base, Prepared for QSP10, QS-3, QS-4	Sub-base, G1/4, G1/8, M7, QS-4, QS-6, QS-8	Sub-base	Sub-base, QS-4, QS-6
Standard nominal flow rate	10 ... 30 l/min	90 ... 400 l/min	300 ... 650 l/min	50 ... 160 l/min
Safety integrity level (SIL)				
Performance level (PL)				
Description	<ul style="list-style-type: none"> • Directly actuated poppet valve • Miniature valve: grid dimension 10 mm • Switching times down to 4 ms • Sub-base valve • Manifold block for 2 ... 10 valves • Use as a pilot valve • UL certification; same connections and cables as for the VUVG 	<ul style="list-style-type: none"> • Directly actuated poppet valve • Fast-switching valve: switching times down to 2 ms • Direct mounting, individual sub-base, manifold assembly • Manifold block for 2 ... 10 valves 	<ul style="list-style-type: none"> • Clean design sub-base valve • Easy-to-clean design • Individual valve for clean design • Can be used in the food zone (based on standard EN 1672-2) 	<ul style="list-style-type: none"> • Directly actuated poppet valve • Identical basic valves for direct mounting or manifold installation • Individual valve with integrated plug connection • Switching frequencies up to 1000 Hz • Very good reproducibility • MHJ9: Valve manifold assembly with individual outputs or with air nozzle output • MHJ9: Electrical connection via connecting cable MHJ9-KMH with integrated control electronics • MHJ10: Valve manifold assembly with individual outputs • MHJ10: Electrical connection via moulded-in cable, control electronics included in the valve
online: →	mh1	mh2	cdvi5.0	mhj9

Product overview

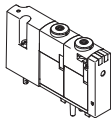

Electrically and pneumatically actuated directional control valves >

Application-specific directional control valves

	 Solenoid valves VOVK	 Solenoid valves VOVC	 Pilot valves VOFX	 Solenoid and pneumatic valves, M5 Compact System J, JD, JMFH, MFH, MUFH, VD, VL, VL/O, VLL
Design	Connection direction downwards, Connection orientation forwards, Poppet valve with spring return	Poppet valve with spring return	Directly actuated poppet valve	Piston gate valve, Poppet seat
Valve function	3/2-way, closed, monostable	2x3/2-way, monostable, closed	3/2-way, closed, monostable	3/2 double solenoid, 3/2 open, single solenoid, 5/2 double solenoid, 5/2-way, bistable, dominant, 5/2-way, monostable
Operating pressure [MPa]	-0.1 ... 0.7 MPa			0.18 ... 0.8 MPa
Operating pressure	-1 ... 7 bar	0 ... 8 bar	-0.9 ... 8 bar	-0.9 ... 8 bar
Ambient temperature	5 ... 50°C	-5 ... 50°C	-10 ... 50°C	-10 ... 60°C
Pneumatic connection 1	Sub-base, For tubing I.D. 1.5 mm, For tubing I.D. 2 mm	Sub-base	G1/8	PK-3
Standard nominal flow rate	5.5 l/min		50 l/min	100 ... 105 l/min
Safety integrity level (SIL)				
Performance level (PL)				
Description	<ul style="list-style-type: none"> • Very narrow: 5.9 mm grid dimension • Extremely small and lightweight • Very low power consumption • Variable connection concepts: flanged connection underneath or at the front, barbed fitting connection at the front • Ideal for control of small air flows 	<ul style="list-style-type: none"> • For valve terminal VTOC • Optimal use of the installation space yet maximum performance • Detenting or non-detenting manual override 	<ul style="list-style-type: none"> • For angle seat valves VZXF and VZXA • For use wherever valve terminals are not economically or technically viable • Manual override, detenting 	<ul style="list-style-type: none"> • Control elements with all functions for pneumatic sequence controls • For control cabinet installation • Fast replacement of components
online: →	vovk	vovc	vofx	m5-compact



Manually actuated directional control valves >

Swivel lever valves

			
	Hand lever valves VHEF-H	Hand lever valves VHER ★	Hand lever valves H-3, H-5
Valve function	3/2 double solenoid, 3/2-way, monostable, open/closed, 5/2 double solenoid, 5/2-way, monostable, 5/3 exhausted, 5/3 closed	4/3-way, pressurised, 4/3 exhausted, 4/3 closed	3/2 double solenoid, 5/2 double solenoid
Type of control	Direct	Direct	Direct
Standard nominal flow rate	530 ... 1200 l/min	170 ... 3800 l/min	550 ... 600 l/min
Pneumatic working port	G1/4, G1/8	G1/2, G1/4, G1/8, M5	G1/4
Operating pressure [MPa]	-0.095 ... 1 MPa		
Operating pressure	-0.95 ... 10 bar	0 ... 10 bar	-0.95 ... 10 bar
Description	<ul style="list-style-type: none"> • With hand lever at the side • Durable thanks to tried-and-tested piston slide and disc seat valve technology • Robust metal housing • Attractive price • Ergonomic and safe operation • Minimal actuating forces • Modern design • Reverse operation possible 	<ul style="list-style-type: none"> • Lever in metal or polymer design • Front panel mounting, through holes or mounting holes 	<ul style="list-style-type: none"> • Die-cast aluminium design
online: →	vhf	vher	n_v14

Manually actuated directional control valves >



Pushbutton valves

			
	Pushbutton valves VHEF-P	Pushbutton valves K/O-3 ★	Pushbutton valves K-3
Valve function	3/2 double solenoid, 3/2-way, monostable, open/closed, 5/2 double solenoid, 5/2-way, monostable	3/2-way, monostable, open/closed	3/2-way, closed, monostable
Type of control	Direct, Pilot actuated	Direct	Direct
Standard nominal flow rate	750 ... 1200 l/min	80 l/min	80 l/min
Pneumatic working port	G1/4, G1/8	PK-3	M5
Operating pressure [MPa]	-0.095 ... 1 MPa		
Operating pressure	-0.95 ... 10 bar	0 ... 8 bar	-0.95 ... 8 bar
Description	<ul style="list-style-type: none"> • With button switch • Durable thanks to tried-and-tested piston slide and disc seat valve technology • Robust metal housing • Attractive price • Ergonomic and safe operation • Minimal actuating forces • Modern design • Reverse operation possible 	<ul style="list-style-type: none"> • With button switch • Polymer design • Ducted exhaust air 	<ul style="list-style-type: none"> • With button switch • Suitable for vacuum operation • Sturdy die-cast zinc design
online: →	vhf	k	k-3

Product overview





Manually actuated directional control valves >

Pushbutton valves

		
Pushbutton valves T-5/3	Pushbutton valves F-3	
Valve function	5/3 closed	3/2-way, closed, monostable
Type of control	Pilot actuated	Direct
Standard nominal flow rate	680 l/min	80 l/min
Pneumatic working port	G1/4	M5
Operating pressure [MPa]	0.2 ... 1 MPa	
Operating pressure	2 ... 10 bar	-0.9 ... 8 bar
Description	<ul style="list-style-type: none"> • With pushbutton • For positioning, for stopping in the event of an emergency stop and for holding double-acting cylinders in any position • Aluminium design 	<ul style="list-style-type: none"> • With pedal • Suitable for vacuum operation • Sturdy die-cast zinc design
online: →	n_msv	f-3-m5



Manually actuated directional control valves >

Finger lever valves

				
Finger lever valves VHEF-L	Finger lever valves TH/O-3	Finger lever valves TH-3, THO-3, TH-5	Finger lever valves H-4/3	
Valve function	3/2-way, monostable, open/closed, 5/2-way, monostable	3/2-way, monostable, open/closed	3/2-way, closed, monostable, 3/2 open, single solenoid, 5/2-way, monostable	4/3 exhausted
Type of control	Direct	Direct	Direct	Pilot actuated
Standard nominal flow rate	750 ... 1200 l/min	80 l/min	80 ... 600 l/min	125 l/min
Pneumatic working port	G1/4, G1/8	PK-3	G1/4, M5	M5
Operating pressure [MPa]	-0.095 ... 1 MPa			
Operating pressure	-0.95 ... 10 bar	0 ... 8 bar	-0.95 ... 10 bar	0 ... 8 bar
Description	<ul style="list-style-type: none"> • With finger lever • Durable thanks to tried-and-tested piston slide and disc seat valve technology • Robust metal housing • Attractive price • Ergonomic and safe operation • Minimal actuating forces • Modern design • Reverse operation possible 	<ul style="list-style-type: none"> • With finger lever • Polymer design • Ducted exhaust air 	<ul style="list-style-type: none"> • With finger lever • Die-cast zinc or die-cast aluminium design 	<ul style="list-style-type: none"> • With detenting finger lever • Front panel mounting or mounting on sub-base • Aluminium design
online: →	vhf	th	th-3-m5	h-4



Manually actuated directional control valves >

Toggle lever valves

	 Toggle lever valves VHEF-V	 Toggle lever valves KH/O-3	 Toggle lever valves H-5/3
Valve function	3/2 double solenoid, 3/2-way, monostable, open/closed, 5/2 double solenoid, 5/2-way, monostable	3/2-way, monostable, open/closed	5/3 closed
Type of control	Direct	Direct	Pilot actuated
Standard nominal flow rate	750 ... 1200 l/min	80 l/min	680 ... 2700 l/min
Pneumatic working port	G1/4, G1/8	PK-3	G1/2, G1/4
Operating pressure [MPa]	-0.095 ... 1 MPa		0.2 ... 1 MPa
Operating pressure	-0.95 ... 10 bar	0 ... 8 bar	2 ... 10 bar
Description	<ul style="list-style-type: none"> • With toggle lever • Durable thanks to tried-and-tested piston slide and disc seat valve technology • Robust metal housing • Attractive price • Ergonomic and safe operation • Minimal actuating forces • Modern design • Reverse operation possible 	<ul style="list-style-type: none"> • With toggle lever • Polymer design • Ducted exhaust air 	<ul style="list-style-type: none"> • With toggle lever • For positioning, for stopping in the event of an emergency stop and for holding double-acting cylinders in any position • Aluminium design
online: →	vhf	kh	n_msv

Manually actuated directional control valves >



Foot valves

	 Foot valves F-3, FO-3, F-5	 Foot valves with detent FP-3, FPB-3, FP-5, FPB-5
Valve function	3/2-way, closed, monostable, 3/2 open, single solenoid, 5/2-way, monostable	3/2 double solenoid, 5/2 double solenoid
Type of control	Direct	Direct
Standard nominal flow rate	550 ... 600 l/min	550 ... 600 l/min
Pneumatic working port	G1/4	G1/4
Operating pressure	-0.95 ... 10 bar	-0.95 ... 10 bar
Description	<ul style="list-style-type: none"> • With foot pedal • Sturdy die-cast zinc design 	<ul style="list-style-type: none"> • With foot pedal with detent • Sturdy die-cast zinc design
online: →	fo-3	fpb-3

Product overview



Manually actuated directional control valves >

Selector switches

	 Selector valves VHEF-ES	 Selector switches HW-6-38
Valve function	3/2 double solenoid, 3/2-way, monostable, open/closed, 5/2 double solenoid, 5/2-way, monostable, 5/3 exhausted, 5/3 closed	8/6 double solenoid
Type of control	Direct	Direct
Standard nominal flow rate	530 ... 1200 l/min	180 l/min
Pneumatic working port	G1/4, G1/8	M5
Operating pressure [MPa]	-0.095 ... 1 MPa	
Operating pressure	-0.95 ... 10 bar	0 ... 8 bar
Description	<ul style="list-style-type: none"> • With selector switch on the side or on top • Durable thanks to tried-and-tested piston slide and disc seat valve technology • Robust metal housing • Attractive price • Ergonomic and safe operation • Minimal actuating forces • Modern design • Reverse operation possible 	<ul style="list-style-type: none"> • With rotary knob and arrow • Front panel mounting or mounting on sub-base • With six switching positions
online: →	vhf	hw-6





Manually actuated directional control valves >

Front panel valves

	 Front panel valves SV/O-3	 Front panel valves SVS-3, SVS-4, SVOS-3	 Front panel valves SV-3, SV-5
Valve function	2x3/2-way, monostable, closed	3/2-way, closed, monostable, 3/2 open, single solenoid, 4/2-way, single solenoid	3/2-way, closed, monostable, 5/2-way, monostable
Type of control	Direct	Direct, Pilot actuated	Direct
Standard nominal flow rate	70 l/min	120 l/min	65 ... 95 l/min
Pneumatic working port	PK-3	G1/8	M5
Operating pressure [MPa]		0.35 ... 0.8 MPa	-0.095 ... 0.8 MPa
Operating pressure	0 ... 8 bar	3.5 ... 8 bar	-0.95 ... 8 bar
Description	<ul style="list-style-type: none"> • For actuator attachments such as toggle and selector switches • Reliable coupling system for quick mounting and dismounting • Polymer design 	<ul style="list-style-type: none"> • For actuator attachments such as pushbutton actuators, mushroom pushbuttons, selector switches, toggle switches, key actuators • Reliable coupling system for quick mounting and dismounting 	<ul style="list-style-type: none"> • For actuator attachments such as pushbutton actuators, mushroom pushbuttons, mushroom pushbuttons with detent, selector switches or toggle switches • Reliable coupling system for quick mounting and dismounting • Polymer design
online: →	sv	svos	sv-3



Mechanically actuated directional control valves >

Stem actuated valves

				
	Stem actuated valves VMEFS ★	Stem actuated valves V/O-3	Stem actuated micro valves S-3, SO-3	Stem actuated valves VS-3, VS-4, VOS-3
Valve function	3/2-way, closed, monostable, 5/2-way, monostable	3/2-way, closed, monostable, 3/2-way, monostable, open/closed	3/2-way, closed, monostable, 3/2 open, single solenoid	3/2-way, closed, monostable, 3/2 open, single solenoid, 4/2-way, single solenoid
Type of control	Direct, Pilot actuated	Direct	Direct	Pilot actuated
Standard nominal flow rate	750 ... 1200 l/min	80 ... 140 l/min	60 l/min	140 ... 161 l/min
Pneumatic working port	G1/4, G1/8	G1/8, M5, PK-3	PK-3	G1/8
Operating pressure [MPa]	-0.095 ... 1 MPa			0.35 ... 0.8 MPa
Operating pressure	-0.95 ... 10 bar	-0.95 ... 8 bar	-0.95 ... 8 bar	3.5 ... 8 bar
Description	<ul style="list-style-type: none"> • Durable thanks to tried-and-tested piston slide and disc seat valve technology • Robust metal housing • Outstanding pneumatic performance • Attractive price • Ergonomic and safe operation • Minimal actuating forces • Modern design • Reverse operation possible 	<ul style="list-style-type: none"> • Through-holes in housing • Polymer, aluminium or die-cast zinc design 	<ul style="list-style-type: none"> • Dimensions to DIN 41635, type A • Polymer design • Various actuator attachments 	<ul style="list-style-type: none"> • Aluminium design • Minimal actuating force with pilot control
online: →	vmef	v/o	s0	vos

Mechanically actuated directional control valves >





Stem actuated valves

			
	Stem actuated valves V-3, V-5, VO-3	Limit switches with push-in connector SDK, SVK	Limit stop signal generators with push-in connector SDV
Valve function	3/2-way, closed, monostable, 3/2 open, single solenoid, 5/2-way, monostable	3/2-way, closed, monostable	3/2-way, closed, monostable
Type of control	Direct	Direct	Direct
Standard nominal flow rate	550 ... 600 l/min	16 ... 50 l/min	8 ... 16 l/min
Pneumatic working port	G1/4	PK-3	PK-3
Operating pressure [MPa]			
Operating pressure	-0.95 ... 10 bar	-0.9 ... 8 bar	0 ... 8 bar
Description	<ul style="list-style-type: none"> • Die-cast aluminium design 	<ul style="list-style-type: none"> • For end-position sensing and position control • High accuracy • Stainless steel design 	<ul style="list-style-type: none"> • For end-position sensing and position control • High precision and low actuating forces • Sturdy design
online: →	vo-3	sdk	sdv

Product overview





Mechanically actuated directional control valves >

Roller lever valves

	 Roller lever valves VMEF-R ★	 Roller lever valves R/O-3-PK-3	 Roller lever valves RS-3, RS-4, ROS-3	 Roller lever valves R-3, R-5, RO-3
Valve function	3/2-way, single solenoid, 5/2-way, monostable	3/2-way, monostable, open/closed	3/2-way, closed, monostable, 3/2 open, single solenoid, 4/2-way, single solenoid	3/2-way, closed, monostable, 3/2 open, single solenoid, 5/2-way, monostable
Type of control	Direct	Direct	Pilot actuated	Direct
Standard nominal flow rate	750 ... 1200 l/min	80 l/min	128 ... 169 l/min	80 ... 600 l/min
Pneumatic working port	G1/4, G1/8	PK-3	G1/8	G1/4, M5
Operating pressure [MPa]	-0.095 ... 1 MPa		0.35 ... 0.8 MPa	
Operating pressure	-0.95 ... 10 bar	0 ... 8 bar	3.5 ... 8 bar	-0.95 ... 10 bar
Description	<ul style="list-style-type: none"> • Durable thanks to tried-and-tested piston slide and disc seat valve technology • Robust metal housing • Outstanding pneumatic performance • Attractive price • Ergonomic and safe operation • Minimal actuating forces • Modern design • Reverse operation possible 	<ul style="list-style-type: none"> • With roller lever • Polymer design • Ducted exhaust air 	<ul style="list-style-type: none"> • With roller lever • Aluminium design • Minimal actuating force with pilot control 	<ul style="list-style-type: none"> • With roller lever • Die-cast aluminium design
online: →	vmef	r/o	ros-3	ro-3



Mechanically actuated directional control valves >

Roller lever valves

	 Roller lever valves VMEF-K	 Toggle lever valves L/O-3	 Roller lever valves LS-3, LS-4, LOS-3	 Roller lever valves L-3, L-5, LO-3
Valve function	3/2-way, single solenoid, 5/2-way, monostable	3/2-way, monostable, open/closed	3/2-way, closed, monostable, 3/2 open, single solenoid, 4/2-way, single solenoid	3/2-way, closed, monostable, 3/2 open, single solenoid, 5/2-way, monostable
Type of control	Direct	Direct	Pilot actuated	Direct
Standard nominal flow rate	750 ... 1200 l/min	80 l/min	128 ... 175 l/min	80 ... 600 l/min
Pneumatic working port	G1/4, G1/8	PK-3	G1/8	G1/4, M5
Operating pressure [MPa]	-0.095 ... 1 MPa		0.35 ... 0.8 MPa	
Operating pressure	-0.95 ... 10 bar	0 ... 8 bar	3.5 ... 8 bar	-0.95 ... 10 bar
Description	<ul style="list-style-type: none"> • Durable thanks to tried-and-tested piston slide and disc seat valve technology • Robust metal housing • Outstanding pneumatic performance • Attractive price • Ergonomic and safe operation • Minimal actuating forces • Modern design • Reverse operation possible 	<ul style="list-style-type: none"> • With roller lever with idle return • Polymer design • Ducted exhaust air 	<ul style="list-style-type: none"> • With toggle lever • Aluminium design • Minimal actuating force with pilot control 	<ul style="list-style-type: none"> • With roller lever • Die-cast aluminium design
online: →	vmef	l/o	los-3	lo-3

Mechanically actuated directional control valves >

Swivel lever valves

			
	Swivel lever valves RW/O-3	Pneumatic limit valves RWN/O-3	Swivel lever valves RW-3
Valve function	3/2-way, monostable, open/closed	3/2-way, monostable, open/closed	3/2-way, closed, monostable
Type of control	Direct		Direct
Standard nominal flow rate	80 ... 140 l/min	120 l/min	80 l/min
Pneumatic working port	G1/8, PK-3	G1/8	M5
Operating pressure	-0.95 ... 8 bar	-0.95 ... 8 bar	-0.95 ... 8 bar
Description	<ul style="list-style-type: none"> • Basic valve for actuator attachments such as short or long swivel lever, swivel lever rod • Aluminium design 	<ul style="list-style-type: none"> • Directly actuated in one direction • Aluminium design 	<ul style="list-style-type: none"> • With swivel lever • Sturdy die-cast zinc design • Various actuator attachments
online: →	rw	rwn	rw-3

Mechanically actuated directional control valves >



Whisker valves

	
	Whisker valves FVS-3, FVSO-3
Valve function	3/2-way, closed, monostable, 3/2 open, single solenoid
Type of control	Pilot actuated
Standard nominal flow rate	146 ... 175 l/min
Pneumatic working port	G1/8
Operating pressure [MPa]	0.35 ... 0.8 MPa
Operating pressure	3.5 ... 8 bar
Description	<ul style="list-style-type: none"> • With whisker • For sensing dissimilar workpieces or workpieces not precisely positioned • Aluminium design • Minimal actuating force with pilot control
online: →	fvs-3

Product overview



Shut-off valves >

Non-return valves and quick exhaust valves

	 Check valves, piloted HGL	 Manual override tools HAB	 Check valves, piloted VBNF
Pneumatic connection 1	G1/2, G1/4, G1/8, G3/8, M5, QS-10, QS-12, QS-4, QS-6, QS-8	G1/2, G1/4, G1/8, G3/8	QS-6, QS-8
Standard nominal flow rate			
Standard nominal flow rate, exhaust 0.6->0.5 MPa (6->5 bar, 87->72.5 psi)		165 l/min	
Standard nominal flow rate, pressurisation 0.6->0.5 MPa (6->5 bar, 87->72.5 psi)			
Standard nominal flow rate 1->2 (0.6->0.5 MPa, 6->5 bar, 87->72.5 psi)	130 ... 1600 l/min		260 ... 620 l/min
Operating pressure [MPa]	0.05 ... 1 MPa		
Operating pressure	0.5 ... 10 bar	0 ... 10 bar	0.2 ... 10 bar
Operating pressure for entire temperature range			0.2 ... 10 bar
Description	<ul style="list-style-type: none"> Valve function: piloted non-return function Screw-in with male thread Pneumatically piloted Pilot air connection: M5, G1/8, G1/4, G3/8, QS-4 Manually actuated exhaust possible with separate accessory 	<ul style="list-style-type: none"> Valve function: exhaust component For check valve HGL For manual exhausting air trapped in a cylinder 	<ul style="list-style-type: none"> Valve function: piloted non-return function Minimal height High flow rate Can be rotated horizontally through 360° in assembled state Manually actuated exhaust possible
online: →	hgl	hab	vbnf

Shut-off valves >





Non-return valves and quick exhaust valves

	 Quick exhaust valves VBQF	 Non-return valves H, HA, HB	 Quick exhaust valves SE, SEU
Pneumatic connection 1	G1/4, G1/8, QS-6, QS-8	G1/2, G1/4, G1/8, G3/4, G3/8, M5, QS-10, QS-12, QS-4, QS-6, QS-8, R1/2, R1/4, R1/8, R3/8	G1/2, G1/4, G1/8, G3/4, G3/8
Standard nominal flow rate		115 ... 2230 l/min	
Standard nominal flow rate, exhaust 0.6->0.5 MPa (6->5 bar, 87->72.5 psi)	850 ... 2500 l/min		550 ... 7500 l/min
Standard nominal flow rate, pressurisation 0.6->0.5 MPa (6->5 bar, 87->72.5 psi)	350 ... 960 l/min		300 ... 4560 l/min
Standard nominal flow rate 1->2 (0.6->0.5 MPa, 6->5 bar, 87->72.5 psi)		1000 ... 5900 l/min	
Operating pressure [MPa]		0.04 ... 1.2 MPa	
Operating pressure	0.2 ... 10 bar	-1 ... 12 bar	0.2 ... 10 bar
Operating pressure for entire temperature range			
Description	<ul style="list-style-type: none"> Minimal height High flow rate Reduced noise emission Available with silencer Available with ducted or unducted exhaust air For higher cycle times 	<ul style="list-style-type: none"> Valve function: non-return function Screw-in or in-line installation With connecting thread at both ends, push-in connector at both ends, thread/push-in connector 	<ul style="list-style-type: none"> Valve function: quick exhaust Shut-off valve, piloted Screw-in With or without silencer
online: →	vbqf	h-gs	se

Product overview





Shut-off valves >

Shut-off valves and ball valves



	 Hand slide valves VBOH	 Shut-off valves HE	 Ball valves QH-QS, QHS-QS	 Ball valves QH
Valve function	3/2 double solenoid	2/2 double solenoid, 3/2 double solenoid	2/2 double solenoid	2/2 double solenoid
Pneumatic connection 1	G1/2, G1/4, G1/8, G3/4, G3/8, M5	QS-10, QS-12, QS-6, QS-8, R1/2, R1/4, R1/8, R3/8	QS-4, QS-6, R1/8	G1, G1 1/2, G1/2, G1/4, G3/4, G3/8
Standard nominal flow rate	236 ... 7691 l/min	256.5 ... 834.3 l/min	148 ... 560 l/min	3400 ... 84000 l/min
Operating pressure [MPa]	-0.095 ... 1.2 MPa	-0.095 ... 1 MPa	-0.1 ... 1 MPa	
Operating pressure	-0.95 ... 12 bar	-0.95 ... 10 bar	-1 ... 10 bar	
Description	<ul style="list-style-type: none"> Used as a shut-off function for pressurising and exhausting compressed air systems, for example upstream of service units, for air guns and also for exhausting pneumatic cylinders Non-overlapping, so no pressure losses when switching Minimal installation effort 	<ul style="list-style-type: none"> Shut-off valve, manually operated Connection: thread at both ends, push-in connector at both ends, thread/push-in connector Different mounting options 	<ul style="list-style-type: none"> Shut-off valve, manually operated In-line installation, can be screwed in, bulkhead fitting Variants: thread at both ends, push-in connector at both ends, thread/push-in connector 	<ul style="list-style-type: none"> Shut-off valve, manually operated In-line installation Female thread at both ends With hand lever Pipe thread to ISO 2281
online: →	vboh	he	qh	qh

Shut-off valves >

Logic valves

	 Logic components OS	 Amplifier modules VK	 NOT modules VLO	 Logic components ZK
Valve function	OR function			AND function
Pneumatic connection 1	G1/2, G1/4, G1/8, PK-3, PK-4	M5	M5	G1/8, PK-3, PK-4
Standard nominal flow rate	100 ... 5000 l/min	80 l/min	80 l/min	100 ... 550 l/min
Operating pressure	0.001 ... 10 bar	0.001 ... 6 bar	0.001 ... 6 bar	0.001 ... 10 bar
Description	<ul style="list-style-type: none"> Pneumatic control system Mounting via through-holes 	<ul style="list-style-type: none"> For pneumatic sensors 	<ul style="list-style-type: none"> For pneumatic sensors 	<ul style="list-style-type: none"> Dual-pressure valve Connects two input signals in the AND function Mounting via through-holes
online: →	os	vk	vlo	zk





Pressure regulators

	 Mini pressure regulating valves LR	 Differential pressure regulators LRL, LRLl	 Pressure regulator VRPA
Design	Diaphragm regulator, With secondary exhausting	Directly actuated piston regulator, With through compressed air supply	
Pressure regulation range		2 ... 6 bar	1 ... 8 bar
Operating pressure	10 bar		
Standard nominal flow rate	150 l/min		80 ... 130 l/min
Nominal flow rate, closed		30 ... 730 l/min	
Nominal flow rate, open		30 ... 760 l/min	
Pneumatic connection 1		G1/2, G1/4, G1/8, G3/8, M5	M5, QS-4, QS-6, QS-8, R1/4, R1/8
Pneumatic connection 2		QS-10, QS-12, QS-4, QS-6, QS-8	QS-4, QS-6, QS-8
Ambient temperature	-10 ... 60°C	0 ... 60°C	0 ... 60°C
Description	<ul style="list-style-type: none"> Regulates the operating pressure independently of the fluctuating inlet pressure Directly actuated diaphragm regulator With secondary exhausting Mounting on sub-base or for front panel mounting 	<ul style="list-style-type: none"> Piston regulator with through pressure supply Constant pressure differential between the input and output Connections: thread/push-in connector on top or on side Without secondary exhaust Without pressure gauge 	<ul style="list-style-type: none"> Regulates the operating pressure independently of the fluctuating inlet pressure With secondary exhaust and with return flow function Piston regulator with through pressure supply Greater energy efficiency thanks to movement-specific pressure adjustment Directly actuated Available with pressure gauge Connections: push-in connector at both ends, thread/push-in connector Sustainable operation thanks to reduced pressure level
online: →	lr	lrl	vrpa

Product overview



Flow control valves >

One-way flow control valves

	 <p>One-way flow control valves VFOE-L</p>	 <p>One-way flow control valves GRLA, GRLZ</p>	 <p>One-way flow control valves VFOH</p>	 <p>One-way flow control valves VFOF</p>
Valve function	Exhaust air one-way flow control function, Supply air one-way flow control function	Exhaust air one-way flow control function, One-way flow control function, Supply air one-way flow control function	Exhaust air one-way flow control function	Exhaust air one-way flow control function
Pneumatic connection 1	QS-10, QS-12, QS-4, QS-6, QS-8	Female thread G1/4, For barbed connector I.D. 4 mm Via union nut, 6 mm Via union nut, G1/2, G1/4, G1/8, G3/4, G3/8, M3, M5, PK-3, PK-3 Via union nut, PK-4, PK-4 Via union nut, PK-6 Via union nut, QS-10, QS-12, QS-3, QS-4, QS-6, QS-8	QS-10, QS-4, QS-6, QS-8	QS-6, QS-8
Standard nominal flow rate in flow control direction	85 ... 1200 l/min	0 ... 4320 l/min	180 ... 530 l/min	240 ... 590 l/min
Adjusting element	Rotary knob with detent	Internal hexagon, Knurled screw, Slotted head screw	External hex	Internal hexagon
Description	<ul style="list-style-type: none"> • Low-cost solution for standard applications • Simple and reliable adjustment of pneumatic cylinder speed • Extremely easy assembly • Fast commissioning • Compact dimensions 	<ul style="list-style-type: none"> • Functional combination of one-way flow control valve and piloted check valve • Flow control valve, flow control at one end • Polymer, metal or stainless steel design • Standard, mini, in-line variants with different flow rates • Connections: thread at both ends, push-in connector at both ends, thread/push-in connector 	<ul style="list-style-type: none"> • Easy-to-clean design • Increased corrosion protection • Can be rotated horizontally through 360° in assembled state 	<ul style="list-style-type: none"> • Functional combination of one-way flow control valve and piloted check valve • High flow rate • Can be rotated horizontally through 360° in assembled state • Compact and can be operated from the side
online: →	vfoe	grla	vfoh	vfof

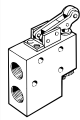

Flow control valves >

One-way flow control valves

			
	One-way flow control valves VFOC	One-way flow control valves GR, GRA	One-way flow control valves GG, GGO, GRR
Valve function	Supply air one-way flow control function	One-way flow control function	One-way flow control function
Pneumatic connection 1	QS-4, QS-6	G1/2, G1/4, G1/8, G3/4, G3/8, M3, M5, QS-3, QS-4, QS-6, QS-8	G1/2, G1/4
Standard nominal flow rate in flow control direction	0 ... 270 l/min	29.5 ... 3300 l/min	870 ... 1300 l/min
Adjusting element	Slotted head screw	Knurled screw	Roller lever
Description	<ul style="list-style-type: none"> Shut-off valve, flow control at one end Metal version Precision adjustment for low and medium speeds Push-in connector/push-in sleeve 	<ul style="list-style-type: none"> Non-return and flow control valve In-line installation 	<ul style="list-style-type: none"> Non-return and flow control valve With roller lever
online: →	vfo	gra	gg

Flow control valves >



One-way flow control valves

		
	Precision one-way flow control valves GRP	One-way flow control valves, M5 Compact System GRF
Valve function	One-way flow control function	One-way flow control function
Pneumatic connection 1	G1/8, PK-3, PK-4	PK-3
Standard nominal flow rate in flow control direction	3.8 ... 75.8 l/min	45 l/min
Adjusting element	Rotary knob with scale	Knurled screw
Description	<ul style="list-style-type: none"> Non-return and flow control valve Mounting on sub-base or for front panel mounting 	<ul style="list-style-type: none"> Complete system offering control components with all the functions required for pneumatic sequence control For control cabinet installation Fast replacement of components
online: →	grp	m5-compact

Product overview



Flow control valves >

Flow control valves

			
	Flow control/silencers VFFK	Flow control valves GRLO	Flow control valves, barbed Y-connector with restrictor GRO, Y-PK3
Valve function	Sound pressure control function	Flow control function	Flow control function
Pneumatic connection 1	M5, M7, R1/4, R1/8	M3, M5	G1/4, G1/8, M5, PK-3, QS-3, QS-4, QS-6
Standard flow rate in flow control direction 6 -> 0 bar		33 ... 169 l/min	
Standard nominal flow rate in flow control direction		18 ... 95 l/min	85 ... 350 l/min
Standard flow rate 0.6->0 MPa (6->0 bar, 87->0 psi)	0 ... 420 l/min		
Adjusting element	Knurled screw	Slotted head screw	Knurled screw
Description	<ul style="list-style-type: none"> With polymer silencer 	<ul style="list-style-type: none"> Flow control valve, flow control at both ends Standard or mini flow control valve Precision adjustment for low and medium speeds Connections: thread at both ends, thread/push-in connector Connections: L-outlet Metal version 	<ul style="list-style-type: none"> Flow control valve, flow control at both ends In-line flow control valve Connections: push-in connector at both ends Connections: in-line, Y-shape Polymer design
online: →	vffk	grlo	gro

Flow control valves >

Flow control valves

		
	Precision flow control valves GRPO	Exhaust air flow control valves, flow control/silencers GRE, GRU
Valve function	Flow control function	Sound pressure control function
Pneumatic connection 1	G1/8, PK-3, PK-4	G1/2, G1/4, G1/8, G3/4, G3/8
Standard flow rate in flow control direction 6 -> 0 bar	5.2 ... 129 l/min	
Standard nominal flow rate in flow control direction	3.8 ... 75.8 l/min	520 ... 3600 l/min
Standard flow rate 0.6->0 MPa (6->0 bar, 87->0 psi)		0 ... 8000 l/min
Adjusting element	Rotary knob with scale	Slotted head screw
Description	<ul style="list-style-type: none"> Connections: threaded connection at both ends, push-in connector at both ends Metal version 	<ul style="list-style-type: none"> Exhaust air flow control valve GRE: sintered metal Flow control/silencer GRU: polymer
online: →	grpo	gre

Flow control valves >

Time delay valves



Time delay valves, M5 Compact System
VLK, VZ, VZO

Pneumatic connection	PK-3
Standard nominal flow rate	60 ... 90 l/min
Adjustable delay time	0.25 ... 5 s
Operating pressure	2.5 ... 8 bar
Type of mounting	Front panel mounting, On mounting frame, Either:
Description	<ul style="list-style-type: none"> • Complete system offering control components with all the functions required for pneumatic sequence control • For control cabinet installation • Fast replacement of components
online: →	m5-compact

Proportional valves >

Flow control valves



Proportional directional control valves
MPYE



Proportional directional control valves
VPWP



Proportional flow control valves
VPCF

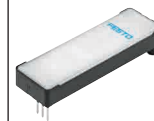





Piezo valves
VEMP

Valve function	5/3 closed	5/3-way proportional directional control valve, closed	3-way proportional flow control valve	2/2-way, closed, monostable, 3/3-way, closed, monostable
Pneumatic connection 1	G1/4, G1/8, G3/8, M5	G1/4, G1/8, G3/8	G3/8	Flange
Flow rate control range			20 ... 1500 l/min	
Operating pressure [MPa]	0 ... 1 MPa	0 ... 1 MPa	0.1 ... 1 MPa	
Operating pressure	0 ... 10 bar	0 ... 10 bar	1 ... 10 bar	0 ... 1.7 bar
Standard nominal flow rate	100 ... 2000 l/min	350 ... 2000 l/min		18 ... 28 l/min
Description	<ul style="list-style-type: none"> • Controlled piston spool valve • Analogue actuation • Setpoint input as analogue voltage signal (0 ... 10 V) • Suitable for servo-pneumatic applications with end-position controller SPC11 	<ul style="list-style-type: none"> • Controlled piston spool valve • Digitally actuated • Integrated pressure sensors for monitoring function and force control • With auto identification • Diagnostic function • Integrated digital output, e.g. for a clamping/brake unit • Suitable for servo-pneumatic applications with axis controller CPX-CMAX and end-position controller CPX-CMPX 	<ul style="list-style-type: none"> • Linear characteristic curve for easy programming • To EU Explosion Protection Directive (ATEX) • Highly dynamic • Piston spool with integrated sensor • Electrical connection via M12x1 plug, 8-pin 	<ul style="list-style-type: none"> • Very low power consumption • No self-heating • Low leakage • Highly precise • Operating medium: air, oxygen, inert gases, nitrogen • Integrated piezo technology • Long service life • Light weight • Mounting: on sub-base, on manifold rail
online: →	mpye	vpwp	vpcf	vemp

Product overview





Proportional valves >

Flow control valves

	 Proportional flow control valves VEMD	 Valve units VPCB	 Proportional directional control valves VPWS	 Piezo valves VEAE
Valve function	2-way proportional flow control valve	3-way proportional pressure regulator	2/2 proportional directional control valve, closed	2/2-way, closed, monostable
Pneumatic connection 1	Female thread M5	G3/8	Cartridge 7.5 mm, Cartridge 15 mm	Flange
Flow rate control range	0 ... 20 l/min			
Operating pressure [MPa]	0 ... 0.25 MPa	0.4 ... 0.8 MPa		0 ... 0.6 MPa
Operating pressure	0 ... 2.5 bar	4 ... 8 bar	0 ... 8 bar	0 ... 6 bar
Standard nominal flow rate		725 l/min		50 ... 81 l/min
Description	<ul style="list-style-type: none"> • Compact module with integrated control electronics • Dynamic regulation with short response time • Mass flow controller (MFC) • Operating medium: air, oxygen, inert gases, nitrogen • Minimal power consumption thanks to piezo technology • Silent: ideal for mobile applications and those close to patients • Direct mounting via thread • Ideal for life sciences applications • Sustainable operation thanks to efficient control 	<ul style="list-style-type: none"> • Valve unit for controlling a pneumatic cylinder in balancer applications • Comprising 3/3-way proportional pressure regulator with special pressure control and shut-off valve actuation as well as two 2/2-way stop valves • Diagnostic display for fast error detection 	<ul style="list-style-type: none"> • Directly actuated poppet valve • Operating medium: air, oxygen, inert gases • Extremely small and lightweight • Compact and cost-effective • Mounting: on sub-base 	<ul style="list-style-type: none"> • Silent operation • Very low power consumption • No self-heating • Integrated piezo technology • Extremely long service life • Operating medium: air, oxygen, inert gases • Small and lightweight • High throughflow • Mounting via through-holes
online: →	vemd	vpcb	vpws	veae

Proportional valves >



Pressure regulators

	 Proportional pressure regulators MPPE	 Proportional pressure regulators MPPES	 NEW Proportional pressure regulators VPPE	 Proportional pressure regulators VPPM
Valve function	3-way proportional-pressure regulator, closed	3-way proportional-pressure regulator, closed	3-way proportional pressure regulator, 3-way proportional-pressure regulator, closed	3-way proportional pressure regulator
Pneumatic connection 1	G1/2, G1/4, G1/8	G1/2, G1/4, G1/8	G1/8	Sub-base, G1/2, G1/4, G1/8
Pressure regulation range [MPa]	0 ... 1 MPa	0 ... 1 MPa	0.002 ... 1 MPa	0.002 ... 1 MPa
Pressure regulation range	0 ... 10 bar	0 ... 10 bar	0.02 ... 10 bar	0.02 ... 10 bar
Operating pressure [MPa]	≤1.2 MPa	≤1.2 MPa	0.8 MPa	
Operating pressure	0 ... 12 bar	≤12 bar	8 bar	
Standard nominal flow rate			310 ... 1250 l/min	380 ... 7000 l/min
NEW			<ul style="list-style-type: none"> • New for 12/2021: additional versions 	
Description	<ul style="list-style-type: none"> • Piloted pressure regulator • Setpoint value input as analogue voltage or current signal • Choice of pressure regulation ranges • Available with setpoint module • Electrical connection via plug, round design to DIN 45326, M16 x 0.75, 8-pin 	<ul style="list-style-type: none"> • Directly actuated (G1/8), pilot actuated (G1/4, G1/2) • Setpoint value input as analogue voltage or current signal • Choice of pressure regulation ranges • Available with setpoint module • Electrical connection via plug, round design to DIN 45326, M16 x 0.75, 8-pin • With proportional solenoid 	<ul style="list-style-type: none"> • Piloted pressure regulator • Setpoint input as analogue voltage signal (0 ... 10 V) • Electrical connection via M12x1 plug, 4 or 5-pin • Available with setpoint module • Variant with display with three retrievable presets and digital controller electronics • For simple control tasks • Variants recommended for production systems for manufacturing lithium-ion batteries 	<ul style="list-style-type: none"> • Piloted pressure regulator • Multi-sensor control (cascade control) • Three default presets for fast commissioning • Integration in valve terminal MPA • User interface with LED displays, LCD display, adjustment/selection buttons • Integrated pressure sensor • Electrical connection via plug connector, round design, 8-pin, M12 or terminal linking
online: →	mppe	mppes	vppe	vppm

Product overview



Proportional valves >

Pressure regulators





			
	Proportional-pressure regulators, NPT VPPM	Proportional pressure regulators VPPX	VPPL
Valve function	3-way proportional pressure regulator	3-way proportional pressure regulator	3-way proportional-pressure regulator, closed
Pneumatic connection 1	1/8 NPT, 1/4 NPT, 1/2 NPT	Sub-base, G1/2, G1/4, G1/8	Flange, G1/4
Pressure regulation range [MPa]	0.006 ... 1 MPa		0.02 ... 4 MPa
Pressure regulation range	0.02 ... 10 bar	0.1 ... 10 bar	0.2 ... 40 bar
Operating pressure [MPa]			≤5 MPa
Operating pressure			≤50 bar
Standard nominal flow rate	380 ... 7000 l/min	1400 ... 7000 l/min	245 l/min
Description	<ul style="list-style-type: none"> • Piloted pressure regulator • Multi-sensor control (cascade control) • Three default presets for fast commissioning • Integration in valve terminal MPA • User interface with LED displays, LCD display, adjustment/selection buttons • Integrated pressure sensor • Electrical connection via plug connector, round design, 8-pin, M12 or terminal linking 	<ul style="list-style-type: none"> • Pressure regulator with additional sensor input • Programmable, freely adjustable PID controller • Multi-sensor control (cascade control) • Control characteristic adjustable via software FCT (Festo Configuration Tool) • Integrated pressure sensor with separate output • Pressure is maintained if the controller fails 	<ul style="list-style-type: none"> • For high-pressure applications • Directly actuated piston regulator • Available in three variants: flanged valve, flanged valve with external pilot air supply, in-line valve
online: →	vppm	vppx	vppl

Proportional valves >

Pressure regulators



			
	Proportional-pressure regulators VEAB	Proportional-pressure regulators VEAA	Proportional-pressure regulators VPPI
Valve function	3-way proportional pressure regulator	3-way proportional pressure regulator	3-way proportional pressure regulator
Pneumatic connection 1	Flange, QS-4	Flange, QS-4	G1/8
Pressure regulation range [MPa]			-0.1 ... 1.2 MPa
Pressure regulation range			-1 ... 12 bar
Operating pressure [MPa]			
Operating pressure			0 ... 13 bar
Standard nominal flow rate	≥4.5 l/min	≥7 l/min	150 ... 1630 l/min
Description	<ul style="list-style-type: none"> • Silent operation • Very low power consumption • Highly precise • Integrated piezo technology • Short switching times • Mounting: using through-holes, H-rail mounting 	<ul style="list-style-type: none"> • Silent operation • Very low power consumption • Highly precise • Integrated piezo technology • Durable • Mounting: via through-holes, H-rail mounting, on mounting plate or sub-base 	<ul style="list-style-type: none"> • Select between three predefined and one customer-specific controller preset • With or without display • Low-noise, flexible and highly dynamic • Precise and stable changeover, rapid switching of setpoint by high-performance moving coil actuator • Control via analogue current or voltage signal, digital pattern for adjustable setpoint values or pulse-width modulation signal
online: →	veab	veaa	vppl

Solenoid-actuated process and media valves





	 Solenoid valves VZWD ★	 Solenoid valves VZWF ★	 Solenoid valves VZWM ★	 Solenoid valves VZWP
Design	Directly actuated poppet valve	Diaphragm valve, Force pilot operated	Diaphragm valve, servo-controlled	Piloted piston poppet valve
Actuation type	Electric	Electric	Electric	Electric
Nominal size	1 ... 6 mm	13.5 ... 50 mm	13 ... 50 mm	13 ... 25 mm
Flow rate Kv	0.06 ... 0.4 m ³ /h	1.8 ... 28 m ³ /h	1.6 ... 39 m ³ /h	1.5 ... 11.5 m ³ /h
Temperature of medium	-10 ... 80°C	-10 ... 80°C	-10 ... 60°C	-10 ... 80°C
Medium pressure	0 ... 90 bar	0 ... 10 bar		0.5 ... 40 bar
Medium pressure of gaseous media			0.5 ... 10 bar	
Medium pressure of liquid media			0.5 ... 6 bar	
Process valve connection	1/4 NPT, 1/8 NPT, G1/4, G1/8, NPT1/4	1 NPT, 1 1/2 NPT, 1 1/4 NPT, 1/2 NPT, 1/4 NPT, 2 NPT, 3/4 NPT, 3/8 NPT, G1, G1 1/2, G1 1/4, G1/2, G1/4, G2, G3/4, G3/8	G1, G1 1/2, G1 1/4, G1/2, G1/4, G2, G3/4, G3/8	1 NPT, 1/2 NPT, 1/4 NPT, 3/4 NPT, 3/8 NPT, G1, G1/2, G1/4, G3/4, G3/8
Description	<ul style="list-style-type: none"> • Extensive pressure range • Directly actuated poppet valve • No differential pressure required • Can also be used in vacuum technology 	<ul style="list-style-type: none"> • High flow rates • Large nominal diameters with relatively small solenoids • No differential pressure required • Can also be used in vacuum technology 	<ul style="list-style-type: none"> • Brass or stainless steel casting design • Electrical connection via solenoid armature tube • Comprehensive range of coils • Coil can be ordered separately 	<ul style="list-style-type: none"> • For all applications with a differential pressure of min. 0.5 bar • For high pressures and high flow rates with relatively small solenoids • For controlling gaseous and liquid media in open circuits
online: →	vzwd	vzwf	vzwm	vzwp

Product overview

Solenoid-actuated process and media valves





	 Solenoid valves MN1H	 Media separated solenoid valves VYKB	 Media separated solenoid valves VYKA
Design	Diaphragm valve	Electrical connection at top, Electrical connection at the side, Rocker valve with diaphragm seal	Rocker valve with diaphragm seal
Actuation type	Electric	Electric	Electric
Nominal size	13 ... 40 mm	1.6 ... 2 mm	1.2 mm
Flow rate Kv		0.034 ... 0.056 m ³ /h	0.013 ... 0.021 m ³ /h
Temperature of medium	-10 ... 60°C	0 ... 50°C	
Medium pressure	0.5 ... 10 bar	-0.75 ... 3 bar	-0.25 ... 2 bar
Medium pressure of gaseous media			
Medium pressure of liquid media			
Process valve connection	G1, G1 1/2, G1/2, G1/4, G3/4, G3/8		
NEW		<ul style="list-style-type: none"> • New product, 5/2021 	
Description	<ul style="list-style-type: none"> • Piloted diaphragm valve • Brass design • Can only be used for gaseous media • Adjustable closing cushioning, in-line mounting or through-hole • Operating voltage 24 V DC, 110/230 V AC (50 ... 60 Hz) 	<ul style="list-style-type: none"> • Compact width of 10 mm or 12 mm • Very easy to clean thanks to media separation • High-quality materials, therefore also suitable for aggressive media • Very flexible in use thanks to 3/2-way or 2/2-way variants as well as 12 or 24 V DC actuation • For dosing, aspirating and for continuous flow applications • Developed according to ISO 13485 • Sustainable operation thanks to efficient control and active air shut-off 	<ul style="list-style-type: none"> • Compact width of 7 mm • Maximum performance and precision in the smallest of spaces • High flow rate with small size • Very easy to clean thanks to media separation • Low media consumption thanks to small internal volume • FDA-listed materials • High-quality materials, therefore also suitable for aggressive media • High repetition accuracy, switching frequency and precision, therefore also suitable for extremely small volumes and dosing tasks • Very flexible in use thanks to 3/2-way and 2/2-way variants as well as 12 ... 26 V DC control • Optionally with slide-on E-box VAVE-K1 with holding current reduction as accessory • Developed according to ISO 13485 • Sustainable operation thanks to efficient control and active air shut-off
online: →	mn1h-2	vykb	vyka

Pneumatically and mechanically actuated process and media valves





	 Angle seat valves VZXF	 Angle seat valves VZXA ★	 Pinch valves VZQA	 Ball valves VZBD
Design	Poppet valve with piston drive	Poppet valve with piston drive, Poppet valve with diaphragm actuator	Pinch valve, pneumatically actuated	2-way ball valve
Valve function	2/2-way, closed, monostable	2/2	2/2-way, closed, monostable, 2/2 open, single solenoid	2/2
Actuation type	Pneumatic	Pneumatic	Pneumatic	Mechanical
Nominal size	12 ... 45 mm			
Nominal size DN	12, 13, 16, 18, 23, 24, 29, 31, 35, 43, 45	13, 20, 25, 32, 40, 50, 65	6, 15, 25	15, 20, 25, 32, 40, 50, 65, 80, 100
Process valve connection			Clamp to ASME-BPE, type A, Clamp to ASME-BPE, type B, Clamp to DIN 32676 series A, 1 NPT, 1/2 NPT, 1/4 NPT, G1, G1/2, G1/4	Clamp to ASME-BPE, Clamp to DIN 32676 series B, Weld-on end to ASME-BPE, Weld-on end to ISO 1127
Flow rate Kv	3.3 ... 43 m ³ /h	4.6 ... 77.9 m ³ /h	0.7 ... 18 m ³ /h	13 ... 1641 m ³ /h
Standard nominal flow rate				
Temperature of medium	-40 ... 200°C	-30 ... 200°C	-5 ... 150°C	-20 ... 200°C
Medium pressure [MPa]	-0.09 ... 4 MPa	0 ... 3 MPa	0 ... 0.6 MPa	
Medium pressure	-0.9 ... 40 bar	0 ... 30 bar	0 ... 6 bar	
Nominal pressure process valve PN	16, 40		10	16
Description	<ul style="list-style-type: none"> Sturdy design Stainless steel and gunmetal process valves with stainless steel, brass or aluminium actuators Different actuator sizes and housing materials Selection of different seat and shaft seals For liquids, gases and other easily contaminated media Easy-to-clean design 	<ul style="list-style-type: none"> Highly flexible, extremely high flow rates Long service life Stainless steel or Ecobross process valves with stainless steel or polymer actuators Modular design Hygienic design, insensitive to dirt Quick and easy maintenance Simple and sturdy: an ideal choice for virtually all media with a viscosity of 600 mm²/s High chemical and thermal resistance Sustainable in production thanks to the use of alternative materials 	<ul style="list-style-type: none"> Modular design Quick and easy replacement of the diaphragm For critical, abrasive and viscous media Easy-to-clean design Flow direction is freely selectable Versions with end-position sensing 	<ul style="list-style-type: none"> Electropolished surfaces SFV4 PTFE seal with little dead space The high-performance ball valve for the pharmaceutical and cosmetics industry FDA-compliant seal to FDA 21 CFR 177.1550
online: →	vzxf	vzxa	vzqa	vzbd

Product overview

Pneumatically and mechanically actuated process and media valves





	 Ball valves VZBE	 Ball valves VZBF	 Ball valves VZBM	 Ball valve actuator units VZBM
Design	2-way ball valve, 2-way ball valve with hand lever, 3-way ball valve, L-hole, T-hole	2-way ball valve	2-way ball valve, 3-way ball valve, L-hole, T-hole	2-way ball valve, 3-way ball valve, Semi-rotary drive
Valve function	2/2, 3/2	2/2	2/2, 3/2	
Actuation type	Mechanical	Mechanical	Mechanical	Pneumatic
Nominal size				
Nominal size DN	8, 10, 15, 20, 25, 32, 40, 50, 65, 80, 100	15, 20, 25, 32, 40, 50, 65, 80, 100, 150, 200	8, 10, 15, 20, 25, 32, 40, 50	8, 10, 15, 20, 25, 32, 40, 50
Process valve connection	1 NPT, 1 1/2 NPT, 1 1/4 NPT, 1/2 NPT, 1/4 NPT, 2 NPT, 2 1/2 NPT, 3 NPT, 3/4 NPT, 3/8 NPT, 4 NPT, Weld-on end according to ASME B16.11	Flange to ANSI B16.5 class 150	Rp1, Rp1 1/2, Rp1 1/4, Rp1/2, Rp1/4, Rp2, Rp3/4, Rp3/8	Rp1, Rp1 1/2, Rp1 1/4, Rp1/2, Rp1/4, Rp2, Rp3/4, Rp3/8
Flow rate Kv	5.1 ... 1637 m ³ /h	8.5 ... 7816 m ³ /h	5.9 ... 243 m ³ /h	5.9 ... 243 m ³ /h
Standard nominal flow rate				
Temperature of medium	-20 ... 200°C	-20 ... 200°C	-20 ... 130°C	-20 ... 130°C
Medium pressure [MPa]				
Medium pressure				
Nominal pressure process valve PN	63	20	25, 40, 50	25, 40
Description	<ul style="list-style-type: none"> • 2-way manual, with lockable hand lever • 2- and 3-way with ISO 5211 head flange, with optional lockable hand lever • Stainless steel design • Pipe thread according to ASME B1.20.1 or welded end according to ASME B16.11 • Optionally with pre-assembled hand lever 	<ul style="list-style-type: none"> • Flanged connections to ANSI B 16.5. class 150 • Static discharge ensured • API 607 Fire Safe certification • Stainless steel design • Easy to service • Optionally with pre-assembled hand lever 	<ul style="list-style-type: none"> • Brass design • Pipe thread to EN 10226-1 	<ul style="list-style-type: none"> • Ball valve actuator unit with double-acting or single-acting quarter turn actuator DFPD • Brass ball valve • 2-way ball valve actuator unit with pipe thread to EN 10226-1 • 3-way ball valve actuator unit with drilled L-hole and pipe thread to EN 10226-1 • 3-way ball valve actuator unit with drilled T-hole and pipe thread to EN 10226-1 • Flow is fully opened or closed in both directions
online: →	vzbe	vzbf	vzbm	vzbm

Pneumatically and mechanically actuated process and media valves



	 Ball valves VAPB	 Ball valves VZBC	 Ball valve actuator units VZBC	 Ball valves VZBA
Design	2-way ball valve	2-way ball valve	2-way ball valve, Semi-rotary drive	2-way ball valve, 3-way ball valve, L-hole, T-hole
Valve function		2/2		2/2, 3/2
Actuation type	Mechanical	Mechanical	Pneumatic	Mechanical
Nominal size				
Nominal size DN	15, 20, 25, 32, 40, 50, 63	15, 20, 25, 32, 40, 50, 65, 80, 100	15, 20, 25, 32, 40, 50, 65, 80, 100	8, 10, 15, 20, 25, 32, 40, 50, 65, 80, 100
Process valve connection	Rp1, Rp1 1/2, Rp1 1/4, Rp1/2, Rp1/4, Rp2, Rp2 1/2, Rp3/4, Rp3/8	Ring housing with threaded flange	Ring housing with threaded flange	Weld-on ends/weld-on ends, Rp1, Rp1 1/2, Rp1 1/4, Rp1/2, Rp1/4, Rp2, Rp2 1/2, Rp3, Rp3/4, Rp3/8, Rp4
Flow rate Kv	5.9 ... 535 m ³ /h	19.4 ... 1414 m ³ /h	19.4 ... 1414 m ³ /h	7 ... 1414 m ³ /h
Standard nominal flow rate				
Temperature of medium	-20 ... 150°C	-10 ... 200°C	-10 ... 200°C	-10 ... 200°C
Medium pressure [MPa]				
Medium pressure				
Nominal pressure process valve PN	25, 40	16, 40	16, 40	63
Description	<ul style="list-style-type: none"> • Automatable 2-way ball valve • Brass design • Blow-out proof shaft • Manual operation possible using hand lever • Connecting thread to EN 10226-1 • Mounting flange to ISO 5211 	<ul style="list-style-type: none"> • Automatable 2-way compact flanged ball valve • Stainless steel design • Short installation length • Blow-out proof shaft • Manual operation possible using hand lever • Flange to DIN 1092-1 • Mounting flange to ISO 5211 • Use in zone 1, 21, 2, 22 	<ul style="list-style-type: none"> • Ball valve actuator unit with double- or single-acting quarter turn actuator DAPS • Stainless steel ball valve in compact design • NAMUR connection pattern for solenoid valves/limit switch attachments to VDI/VDE 3845 • Flow is fully opened or closed in both directions • Use in zone 1, 21, 2, 22 	<ul style="list-style-type: none"> • Automatable 2-way or 3-way ball valve • Stainless steel design • Blow-out proof shaft • Manual operation possible using hand lever • Connecting thread to EN 10226-1 • Mounting flange to ISO 5211 • Use in zone 1, 21, 2, 22
online: →	vapb	vzbc	vzbc	vzba

Product overview



Pneumatically and mechanically actuated process and media valves

	 Ball valve actuator units VZBA	 Ball valve actuator units VZPR	 Pneumatic valves VLX	 Media separated pneumatic valves VZDB
Design	2-way ball valve, 3-way ball valve, L-hole, Semi-rotary drive, T-hole	2-way ball valve, Semi-rotary drive	Diaphragm valve	Rocker valve with diaphragm seal
Valve function			2/2-way, closed, monostable	2/2-way, closed, monostable, 3/2-way, monostable, open/closed
Actuation type	Pneumatic	Electric, Pneumatic	Pneumatic	Pneumatic
Nominal size			13 ... 25 mm	1.6 mm
Nominal size DN	8, 10, 15, 20, 25, 32, 40, 50, 65, 80, 100	15, 20, 25, 32, 40, 50, 63		
Process valve connection	Weld-on ends/weld-on ends, Rp1, Rp1 1/2, Rp1 1/4, Rp1/2, Rp1/4, Rp2, Rp2 1/2, Rp3, Rp3/4, Rp3/8, Rp4	Rp1, Rp1 1/2, Rp1 1/4, Rp1/2, Rp1/4, Rp2, Rp2 1/2, Rp3/4, Rp3/8	G1, G1/2, G1/4, G3/4, G3/8	Male thread/male thread
Flow rate Kv	7 ... 1414 m ³ /h			0.034 m ³ /h
Standard nominal flow rate			2400 ... 14000 l/min	
Temperature of medium	-10 ... 200°C	-20 ... 150°C	-10 ... 80°C	0 ... 50°C
Medium pressure [MPa]				
Medium pressure			1 ... 10 bar	
Nominal pressure process valve PN	63	25, 40		
NEW				• New product, 5/2021
Description	<ul style="list-style-type: none"> • Ball valve actuator unit with double- or single-acting quarter turn actuator DAPS • Stainless steel ball valve • NAMUR connection pattern for solenoid valves/limit switch attachments to VDI/VDE 3845 • Flow is fully opened or closed in both directions • Use in zone 1, 21, 2, 22 	<ul style="list-style-type: none"> • Ball valve actuator unit with double-acting quarter turn actuator DAPS • Brass ball valve • NAMUR connection pattern for solenoid valves/limit switch attachments to VDI/VDE 3845 • Flow is fully opened or closed in both directions 	<ul style="list-style-type: none"> • Poppet valve • Indirectly actuated • Brass design • In-line mounting 	<ul style="list-style-type: none"> • Compact width of 10 mm • Very easy to clean thanks to media separation • High-quality materials, therefore also suitable for aggressive media • For dosing, aspirating and for continuous flow applications • Developed according to ISO 13485
online: →	vzba	vzpr	vlx	vzdb

Pneumatic control systems

			
	Quickstepper FSS	Control blocks for two-hand start ZSB	Pneumatic counters, M5 Compact System PZA, PZV
Design	Sequencer, additive		Mechanical sequence counter with pneumatic drive
Actuation type		Pneumatic	
Pneumatic connection			M5
Pneumatic connection 2		G1/8	
Type of mounting		With through-hole, Via female thread, Either:	Front panel mounting, With through-hole
Operating pressure	2.5 ... 6 bar	4 ... 8 bar	2 ... 8 bar
Performance level (PL)		Two-hand operation/category 1, Performance Level c	
Description	<ul style="list-style-type: none"> • Pneumatic/mechanical sequencer with 12 steps and linked to start • Ready-to-install sequence controller • Feedback-controlled motion sequences • Quick to replace, tubing can be left in place 	<ul style="list-style-type: none"> • Used wherever manual actuation poses a risk of accident to operating personnel • With safety functions 	<ul style="list-style-type: none"> • Complete system offering control components with all the functions required for pneumatic sequence control • For control cabinet installation • Fast replacement of components • Available with protective cap
online: →	fss	zsb	pza



Pneumatic control systems

		
	Timers, M5 Compact System PZVT	Electrical counters CCES
Design	Mechanical sequence counter with pneumatic drive	Electric adding counter with battery
Actuation type		
Pneumatic connection	Female thread M5	
Pneumatic connection 2		
Type of mounting	Front panel mounting	Front panel mounting
Operating pressure	2 ... 6 bar	
Performance level (PL)		
Description	<ul style="list-style-type: none"> • Complete system offering control components with all the functions required for pneumatic sequence control • For control cabinet installation • Fast replacement of components • Mechanical sequence counter with pneumatic drive • Adjustable delay time • Available with protective cap 	<ul style="list-style-type: none"> • 8-digit LCD display • Independent power supply • Connection via terminal strip • Reset button
online: →	pzvt	cces

Product overview

Accessories for valves >

Function components

	 Vacuum blocks VABF-S4-1-V2B1	 Vacuum generators VABF-S4-2-V2B1
Width		35 mm
Nominal width of Laval nozzle	2 mm	1.4 mm, 2 mm, 3 mm
Ejector characteristics	High vacuum, Standard	High suction rate, High vacuum, Standard
Integrated function	Electric ejector pulse valve, Flow control, Electric on-off valve, Air saving function, electrical, Check valve, Open silencer, Vacuum switch	Electric ejector pulse, Flow control, Electric on-off valve, Air saving function, electrical, Power ejector pulse valve, electric, Check valve, Open silencer, Vacuum switch
Max. vacuum		0.092 MPa
Display type		LED, LED indicator, 2-digit
Description	<ul style="list-style-type: none"> • In conjunction with a suction gripper to pick up, hold and place components • Can be integrated in valve terminal VTSA, VTSA-F • With air-saving function and adjustable ejection pulse 	<ul style="list-style-type: none"> • In conjunction with a suction gripper to pick up, hold and place components • Can be integrated in valve terminal VTSA-F-CB • With air-saving function and adjustable ejection pulse • Variants with high vacuum or high suction volume flow • Variants with energy- and air-saving power ejector pulse
online: →	vabf-s4	vabf-s4

Customised components – for your specific requirements

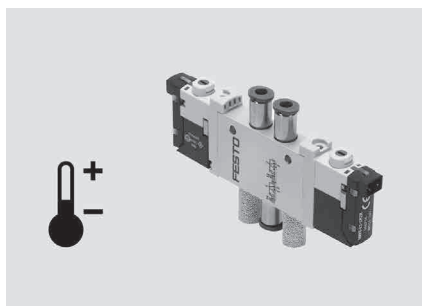

Valves with customised designs

Can't find the valve you need in our catalogue?

We can offer you customised components that are tailored to your specific requirements.

Common product modifications:

- Coatings for special ambient conditions
- Customised cables: length, pin allocation, pre-assembled with plug
- Modified actuating elements
- Modified connecting thread
- Modified valve sub-bases

Many additional variants are possible.

Ask your Festo sales engineer, who will be happy to help you:

→ www.festo.com/contact

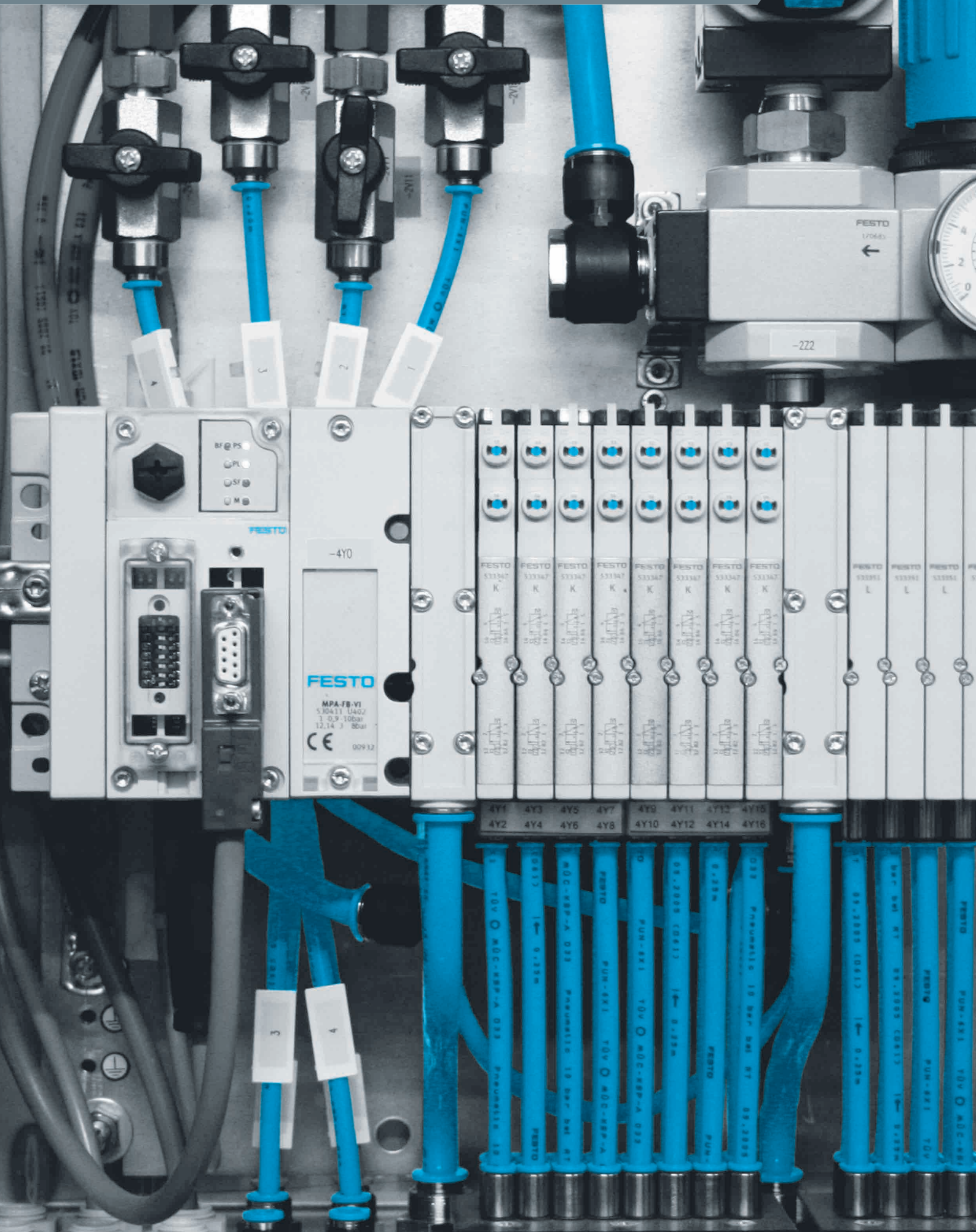

Product overview

Software tools

Configurator for valve terminals



Design a product with numerous features reliably and quickly with the help of the configurator.

Select all the required product features step-by-step. The use of logic checks ensures that only correct configurations are available for selection.

A dynamic graphic generated on the basis of the configuration provides a visual aid for selecting the correct product features.

You can find the configurator for your product

- at www.festo.com/catalogue/ventilinsel
- Select the product you want
- Click on the blue "Configure product" button

Standards-based valve terminals

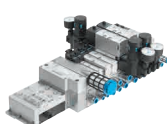

Valve terminals
VTSA





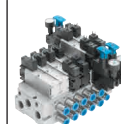

Valve terminals
VTSA-NPT



Valve manifolds to ISO 15407-1
VTIA



	Valve terminals VTSA	Valve terminals VTSA-NPT	Valve manifolds to ISO 15407-1 VTIA
Valve size	18 mm, 26 mm, 42 mm, 52 mm, 65 mm	18 mm, 26 mm, 42 mm, 52 mm, 65 mm	18 mm, 26 mm
Valve function	2x2/2-way, monostable, closed, 2x3/2-way, monostable, closed, 2x3/2-way, open, monostable, 2x3/2-way, open/closed, monostable, 5/2 double solenoid, 5/2-way, bistable, dominant, 5/2-way, monostable, 5/2-way, monostable, safety function, 5/3-way, pressurised, 5/3 exhausted, 5/3 closed, 5/3-way, port 2 pressurised, 4 exhausted	2x2/2-way, monostable, closed, 2x3/2-way, monostable, closed, 2x3/2-way, open, monostable, 2x3/2-way, open/closed, monostable, 5/2 double solenoid, 5/2-way, bistable, dominant, 5/2-way, monostable, 5/2-way, monostable, safety function, 5/3-way, pressurised, 5/3 exhausted, 5/3 closed, 5/3-way, port 2 pressurised, 4 exhausted	2x3/2-way, monostable, closed, 2x3/2-way, open, monostable, 2x3/2-way, open/closed, monostable, 5/2 double solenoid, 5/2-way, bistable, dominant, 5/2-way, monostable, 5/3-way, pressurised, 5/3 exhausted, 5/3 closed
Max. standard nominal flow rate	550 l/min at 18 mm, 1100 l/min at 26 mm, 1300 l/min at 42 mm, 2900 l/min at 52 mm, 4000 l/min at 65 mm	550 l/min at 18 mm, 1100 l/min at 26 mm, 1300 l/min at 42 mm, 2900 l/min at 52 mm, 4000 l/min at 65 mm	550 l/min at 18 mm, 1100 l/min at 26 mm
Max. no. of valve positions	32	32	16
	32	32	3
Electrical actuation	Ethernet, Fieldbus, Multi-pin plug, IO-Link®, Integrated controller	Ethernet, Fieldbus, Multi-pin plug, IO-Link®, Integrated controller	Individual connection
Valve terminal design	Modular, valve sizes can be mixed	Modular, valve sizes can be mixed	Modular, valve sizes can be mixed
Description	<ul style="list-style-type: none"> • Conforms to ISO 15407-2/ISO 5599-2 • Multi-pin plug connection or fieldbus connection via the CPX system • Five valve sizes can be combined on one valve terminal • Integratable safety functions 	<ul style="list-style-type: none"> • Conforms to ISO 15407-2/ISO 5599-2 • Multi-pin plug connection or fieldbus connection via the CPX system • Five valve sizes can be combined on one valve terminal • Integratable safety functions 	<ul style="list-style-type: none"> • Conforms to ISO 15407-1 • Wide range of individual electrical connections • Two valve sizes can be combined • Standardised electrical connection: square plug type C or individual connection with M8/M12 central plug
online: →	vtsa	vtsa	vtia

Universal valve terminals



	 Valve manifolds VTUG-S	 Valve terminals with multi-pin plug/fieldbus connection VTUG	 Valve terminal VTUG-EX with multi-pin, fieldbus interface VTUG-EX	 Valve terminal with multi-pin, fieldbus interface VTUG-F1A
Valve size	10 mm, 14 mm, 18 mm	10 mm, 14 mm, 18 mm	10 mm, 14 mm, 18 mm	10 mm, 14 mm
Valve function	2x3/2-way, monostable, closed, 2x3/2-way, open, monostable, 2x3/2-way, open/closed, monostable, 5/2 double solenoid, 5/2-way, monostable, 5/3-way, pressurised, 5/3 exhausted, 5/3 closed	2x3/2-way, monostable, closed, 2x3/2-way, open, monostable, 2x3/2-way, open/closed, monostable, 3/2-way, closed, monostable, 3/2 open, single solenoid, 5/2 double solenoid, 5/2-way, monostable, 5/3-way, pressurised, 5/3 exhausted, 5/3 closed	2x3/2-way, monostable, closed, 2x3/2-way, open, monostable, 2x3/2-way, open/closed, monostable, 3/2-way, closed, monostable, 3/2 open, single solenoid, 5/2 double solenoid, 5/2-way, monostable, 5/3-way, pressurised, 5/3 exhausted, 5/3 closed	5/3 closed, 2x3/2-way, monostable, closed, 2x3/2-way, open/closed, monostable, 5/3-way, pressurised, 5/2 double solenoid, 2x3/2-way, open, monostable, 3/2 open, single solenoid, 5/2-way, monostable, 3/2-way, closed, monostable, 5/3 exhausted
Max. standard nominal flow rate	380 l/min at 10 mm, 780 l/min at 14 mm, 1380 l/min at 18 mm	330 l/min at 10 mm, 630 l/min at 14 mm, 1200 l/min at 18 mm	330 l/min at 10 mm, 630 l/min at 14 mm, 1200 l/min at 18 mm	330 l/min at 10 mm, 630 l/min at 14 mm
Max. no. of valve positions	16 9	24 13	24 13	24 13
Electrical actuation	Individual connection	Individual connection, Fieldbus, Multi-pin plug, IO-Link®, I-Port, AP interface	Fieldbus, Multi-pin plug, IO-Link®, I-Port	AP interface, Multi-pin plug, IO-Link®, I-Port
Valve terminal design	Fixed grid	Fixed grid	Fixed grid	Fixed grid
Description	<ul style="list-style-type: none"> • Compact with small VUVG valves • Connection technology easy to change via the E-box • Wide range of valve functions • Also with semi in-line valves 	<ul style="list-style-type: none"> • Low-cost fixed grid • Extremely easy assembly • Exchangeable electrical control • IO-Link® capable • Valves VUVG with individual electrical connection can be integrated • Also available with pneumatic multiple connector plate • Part of the VG series • Energy-efficient thanks to reverse operation and targeted pressure reduction • Optimised and space-saving variant available for installation in control cabinets • Variants with hot-swap connections: valves can be replaced during operation • Variants recommended for production systems for manufacturing lithium-ion batteries 	<ul style="list-style-type: none"> • To EU Explosion Protection Directive (ATEX) • Stainless-steel-coated terminal strips for extreme corrosion resistance, suitable for control cabinets and environments up to IP69k 	<ul style="list-style-type: none"> • Recommended for production systems for manufacturing lithium-ion batteries • Low-cost fixed grid • Extremely easy assembly • Exchangeable electrical control • IO-Link® capable • Part of the VG series • Energy-efficient thanks to reverse operation and targeted pressure reduction
online: →	vtug	vtug	vtug	vtug-f1a

Product overview

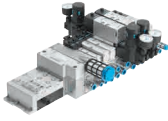
Universal valve terminals

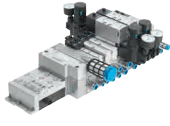

	 Valve manifolds VTUS	 Valve terminals MPA-L	 Valve terminals MPA-S	 Valve terminals VTSA-F
Valve size	21 mm, 26.5 mm, 31 mm	10 mm, 14 mm, 20 mm	10 mm, 14 mm, 20 mm	18 mm, 26 mm, 42 mm, 52 mm, 65 mm
Valve function	2x3/2-way, monostable, closed, 2x3/2-way, open, monostable, 2x3/2-way, open/closed, monostable, 3/2-way, closed, monostable, 3/2 open, single solenoid, 5/2 double solenoid, 5/2-way, monostable, 5/3-way, pressurised, 5/3 exhausted, 5/3 closed	2/2-way, closed, monostable, 2x3/2-way, monostable, closed, 2x3/2-way, open, monostable, 2x3/2-way, open/closed, monostable, 3/2-way, closed, monostable, 3/2 open, single solenoid, 5/2 double solenoid, 5/2-way, monostable, 5/3-way, pressurised, 5/3 exhausted, 5/3 closed	2/2-way, closed, monostable, 2x3/2-way, monostable, closed, 2x3/2-way, open, monostable, 2x3/2-way, open/closed, monostable, 3-way proportional pressure regulator, 3/2-way, closed, monostable, 3/2 open, single solenoid, 5/2 double solenoid, 5/3-way, pressurised, 5/3 exhausted, 5/3 closed	2x2/2-way, monostable, closed, 2x3/2-way, monostable, closed, 2x3/2-way, open, monostable, 2x3/2-way, open/closed, monostable, 5/2 double solenoid, 5/2-way, bistable, dominant, 5/2-way, monostable, 5/2-way, monostable, safety function, 5/3-way, pressurised, 5/3 exhausted, 5/3 closed, 5/3-way, port 2 pressurised, 4 exhausted
Max. standard nominal flow rate		360 l/min at 10 mm, 670 l/min at 14 mm, 870 l/min at 20 mm	360 l/min at 10 mm, 550 l/min at 14 mm, 700 l/min at 20 mm	700 l/min at 18 mm, 1350 l/min at 26 mm, 1860 l/min at 42 mm, 2900 l/min at 52 mm, 4000 l/min at 65 mm
Max. no. of valve positions	16	32	24, 32, 64, 8	32
	9	20	3, 7, 9, 17	16
Electrical actuation	Individual connection	Fieldbus, Multi-pin plug, IO-Link®, I-Port	AS-Interface, Fieldbus, Multi-pin plug	Ethernet, Fieldbus, Integrated controller, Multi-pin plug, IO-Link®
Valve terminal design	Fixed grid	Valve sizes can be mixed	Modular, valve sizes can be mixed	Modular, valve sizes can be mixed
Description	<ul style="list-style-type: none"> Sturdy valves VUVS with long service life Individual electrical connection Pilot air supply in the manifold rail Comprehensive range of accessories 	<ul style="list-style-type: none"> Maximum modularity System can be extended as required with individual sub-bases and modular tie rods Polymer sub-bases 3 valve sizes Tamper-proof fixed flow restrictor Fieldbus interface via CPX IO-Link® capable 	<ul style="list-style-type: none"> Valve terminals for universal applications High-performance valves in a sturdy metal housing Metal linking Two valve sizes can be combined Excellent communication thanks to serial linking Fieldbus interface via CPX Max. 128 valves 	<ul style="list-style-type: none"> Flow rate-optimised valve terminal VTSA Linking with increased flow rates Functions like standard valve manifolds VTSA
online: →	vtus	mpa-l	mpa-s	vtsa

Universal valve terminals

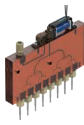

	 Valve terminals VTSA-F-CB	 Valve terminals VTSA-F-NPT	 Valve terminals CPV-SC
Valve size	18 mm, 26 mm, 42 mm, 52 mm	18 mm, 26 mm, 42 mm, 52 mm, 65 mm	10 mm
Valve function	2x2/2-way, monostable, closed, 2x3/2-way, monostable, closed, 2x3/2-way, open, monostable, 2x3/2-way, open/closed, monostable, 5/2 double solenoid, 5/2-way, bistable, dominant, 5/2-way, monostable, 5/3-way, pressurised, 5/3 exhausted, 5/3 closed, 5/3-way, port 2 pressurised, 4 exhausted	2x2/2-way, monostable, closed, 2x3/2-way, monostable, closed, 2x3/2-way, open, monostable, 2x3/2-way, open/closed, monostable, 5/2 double solenoid, 5/2-way, bistable, dominant, 5/2-way, monostable, 5/2-way, monostable, safety function, 5/3-way, pressurised, 5/3 exhausted, 5/3 closed, 5/3-way, port 2 pressurised, 4 exhausted	2/2-way, closed, monostable, 3/2-way, closed, monostable, 3/2 open, single solenoid, 5/2 double solenoid, 5/2-way, monostable
Max. standard nominal flow rate	700 l/min at 18 mm, 1350 l/min at 26 mm, 1860 l/min at 42 mm, 2900 l/min at 52 mm	700 l/min at 18 mm, 1350 l/min at 26 mm, 1860 l/min at 42 mm, 2900 l/min at 52 mm, 4000 l/min at 65 mm	170 l/min at 10 mm
Max. no. of valve positions		32 16	16 8
Electrical actuation	Fieldbus, Ethernet, Integrated controller	Ethernet, Fieldbus, Multi-pin plug, Integrated controller, IO-Link®	CPI installation system, Individual connection, Fieldbus, Multi-pin plug
Valve terminal design	Modular, valve sizes can be mixed	Modular, valve sizes can be mixed	Fixed grid
Description	<ul style="list-style-type: none"> Valve terminal VTSA optimised for flow rate and communication Extended diagnostic functions via CBUS and LED display Previous external cabling is now unnecessary, while the installation space remains the same Up to 96 valve addresses and up to four voltage zones, three of which can be safely shut off For applications with increased safety requirements such as manual work stations Control via CPX pneumatic interface with serial communication Five valve sizes can be combined on one valve terminal 	<ul style="list-style-type: none"> Flow rate-optimised valve terminal VTSA Linking with increased flow rates Functions like standard valve manifolds VTSA 	<ul style="list-style-type: none"> Small and compact High flow rate even with a compact design Suitable for vacuum Multi-pin or fieldbus control
online: →	vtsa-f	vtsa	cpv-sc

Product overview

Application-specific valve terminals

	 Dispense heads VTOE	 Dispense heads VTOI	 Valve terminals MPA-C
Valve size	9 mm	9 mm	14 mm, 26.8 mm
Valve function	2/2-way, closed, monostable	2/2-way, closed, monostable	2/2-way, closed, monostable, 2x3/2-way, monostable, closed, 2x3/2-way, open, monostable, 2x3/2-way, open/closed, monostable, 3/2-way, closed, monostable, 3/2 open, single solenoid, 5/2 double solenoid, 5/2-way, monostable, 5/3-way, pressurised, 5/3 exhausted, 5/3 closed
Nominal size DN	0.8 mm	0.8 mm	
Nominal width of dosing needle	0.32 ... 1 mm	0.3 mm	
Max. standard nominal flow rate			780 l/min at 14 mm
Operating pressure [MPa]	0 ... 0.05 MPa	-0.02 ... 0.1 MPa	-0.09 ... 0.8 MPa
Operating pressure	0 ... 0.5 bar	-0.2 ... 1 bar	-0.9 ... 8 bar
Operating pressure [psi]	0 ... 7.25 psi	-2.9 ... 14.5 psi	-13.05 ... 116 psi
Electrical connection	2-wire, 9-pin, Cable, Plugs, Sub-D, Open end	2-wire, 2x single wires, Open end	
Electrical actuation			Multi-pin plug, IO-Link®, I-Port
Nominal operating voltage DC	24 V	24 V	24 V
Max. no. of valve positions			32
Valve terminal design			Modular and expandable
Description	<ul style="list-style-type: none"> • Basic function: dosing • Ready-to-install dosing solution saves time and costs • Compact 9 mm grid dimension • Suitable for sensitive and aggressive liquids • Ideally suited to non-contact dispensing of liquid media • Maximum dosing precision down to the microlitre range • Small internal volume makes it easy to rinse • 1- or 8-channel dispense head • Typical coefficient variation (CV): < 1% at 10 to 1000 µl 	<ul style="list-style-type: none"> • Basic function: dosing and aspiration • Highly precise • Compact 9 mm grid dimension • Ideal for microwell plates • 8-channel dispense head • Simple design with side-by-side mounting for increased throughput • High-quality materials, therefore also suitable for aggressive media • The complete dispensing system can be designed with just a few components • A 96-way dispense head can be realised using just 12 valves 	<ul style="list-style-type: none"> • Valve terminal in clean design • Easy-to-clean design • High corrosion resistance • Degree of protection IP69K • FDA-compliant materials • Redundant sealing system
online: →	vtoe	vtoi	mpa-c

Application-specific valve terminals





	 Valve terminals VTOC	 Valve terminals MH1
Valve size	10 mm	10 mm
Valve function	2x3/2-way, monostable, closed	2/2-way, closed, monostable, 3/2-way, closed, monostable, 3/2 open, single solenoid
Nominal size DN		0.9 mm
Nominal width of dosing needle		
Max. standard nominal flow rate	10 l/min at 10 mm	10 l/min at 10 mm
Operating pressure [MPa]		
Operating pressure	0 ... 8 bar	-0.9 ... 8 bar
Operating pressure [psi]		
Electrical connection		
Electrical actuation	Multi-pin plug, IO-Link®, I-Port	Individual connection, Multi-pin plug
Nominal operating voltage DC	24 V	5 V, 12 V, 24 V
Max. no. of valve positions	24	24
Valve terminal design	Fixed grid	Fixed grid
Description	<ul style="list-style-type: none"> • Compact pilot valves • Compact assembly • Greater safety thanks to interlock function • Multi-pin or fieldbus control • IO-Link® capable 	<ul style="list-style-type: none"> • Miniaturised poppet valves • Multi-pin or electrical individual connection
online: →	vto	mh1

Software tools



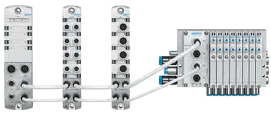

Commissioning software Festo Automation Suite		A quick and reliable way to a ready-to-use drive system, the Festo Automation Suite combines the parameterisation, programming and maintenance of complete drive systems from the mechanics to the control system – and all with just one software. Perfect for making industrial automation simple, efficient and consistent.
<p>Plug-in automation system CPX-E</p> <ul style="list-style-type: none"> • Controller programming in CODESYS as a system expansion for applications ranging from SoftMotion to robotics • Just 2 mouse clicks instead of 100: greatly simplified integration of the servo drive CMMT-AS into the control program with CPX-E-CEC • Conveniently install the plug-in using the software 		
This tool can be found on our website at → www.festo.com/AutomationSuite		

Product overview

Electrical peripherals

	 Automation systems CPX-API	 Terminal CPX	 Fieldbus modules CTEU	 CPI installation systems CTEC
Protocol	IO-Link, PROFIBUS DP, PROFINET, EtherCAT, EtherNet/IP, Modbus@TCP	Interbus, DeviceNet, CANopen, CC-Link, PROFIBUS DP, PROFINET, EtherCAT, EtherNet/IP, Modbus@TCP, SercosIII, Powerlink, IO-Link®, I-Port, HART	AS-Interface, CANopen, CC-LINK, CPI-B, DeviceNet, EtherCAT, EtherNet/IP, PROFINET, Modbus@ TCP, PROFIBUS DP, VARAN, I-Port	Interbus, DeviceNet, CANopen, PROFIBUS DP, PROFINET
Electrical actuation		Fieldbus, Integrated controller		Fieldbus, Integrated controller
Max. address capacity, inputs		64 Byte	2 ... 64 Byte	
Maximum address volume for outputs		64 Byte	2 ... 64 Byte	
Parameterisation		Diagnostic behaviour, Fail-safe response, Forcing of channels, Signal setup	Activate diagnostics, Diagnostic behaviour, Fail-safe and idle response, Fail-safe response, IO-Link mode, Watchdog disable, Watchdog enable	
Degree of protection		IP65, IP67	IP65, IP67	IP65, IP67
Nominal operating voltage DC		24 V	24 ... 30 V	24 V
Operating voltage range DC		18 ... 30 V	18 ... 31.6 V	
Description	<ul style="list-style-type: none"> • Powerful remote I/O system that flexibly links 80 modules at a data rate of 200 Mbaud in real-time • Seamless connectivity along with advanced diagnostics option increase the machine availability and productivity • Simple integration into the controller of your choice: PROFINET, PROFIBUS, EtherCAT®, EtherNet/IP, ModbusTCP • Real-time capability and deterministic system behaviour enable cycle times of up to 250 µs • Cable lengths of up to 50 m between every module enable vast system dimensions • The IO-Link master and parameterisation software enable simple integration of any IO-Link® devices • Ethernet performance up to the valve terminal and digital as well as analogue input/output modules 	<ul style="list-style-type: none"> • Automation platform • Open to all common fieldbus protocols and Ethernet • Integrated diagnostic and maintenance functions • Can be used as stand-alone remote I/O or with valve terminals MPA-S, MPA-L, VTSA/VTSA-F • Choice of polymer or metal interlinking block with individual linking • Analogue inputs and outputs, 2-way/4-way, with optional HART protocol 	<ul style="list-style-type: none"> • For valve terminals VTUG, MPA-L, VTOC • Can be expanded into the installation system CTEL • Fieldbus-typical LEDs, interfaces and switching elements • Isolated power supply for electronics and valves 	<ul style="list-style-type: none"> • CPX master module for four CPI strings • Combination of centralised and decentralised installation possible • Decentralised pneumatic components and sensors for fast processes • Can be connected to valve terminal MPA-S, CPV-SC
online: →	cpx-api	cpx	cteu	ctec

Electrical peripherals

	 Automation systems CPX-E	 Terminal CPX-P	 AS-Interface® module ASI	 Electrical interfaces CPX-CTEL
Protocol	PROFIBUS DP, PROFINET, EtherCAT, EtherNet/IP, Modbus®TCP, IO-Link®	DeviceNet, CANopen, PROFIBUS DP, PROFINET, EtherCAT, EtherNet/IP, Modbus®TCP, IO-Link®, I-Port, HART	AS-Interface®	I-Port, IO-Link®
Electrical actuation	Fieldbus, Integrated controller	Fieldbus, Integrated controller		
Max. address capacity, inputs	64 Byte	64 Byte		32 Byte
Maximum address volume for outputs	64 Byte	64 Byte		32 Byte
Parameterisation		Diagnostic behaviour, Fail-safe response, Forcing of channels, Signal setup		Diagnostic behaviour, Fail-safe per channel, Forcing per channel, Idle mode per channel, Module parameters, Tool-change mode
Degree of protection	IP20	IP20, IP65	IP65/IP67 (when fully plugged-in or fitted with protective cap)	IP65, IP67
Nominal operating voltage DC		24 V	Sensors 24 V	24 V
Operating voltage range DC				18 ... 30 V
Description	<ul style="list-style-type: none"> • Modern control system with high performance • Fieldbus master interfaces, EtherCAT® master, fieldbus slave interfaces, PROFINET, EtherNet/IP, PROFIBUS, EtherCAT® digital input modules (16DI), digital output modules (8DO/0.5A) • Analogue input modules (current, voltage), analogue output modules (current, voltage) • Modern programming with CoDeSys V3 to IEC 61131-3 • Integration of SoftMotion functions (SoftMotion) • Compact I/O assembly • Easy mounting of the control system 	<ul style="list-style-type: none"> • Use of matching remote I/O and valve terminals in a control cabinet • Combination with modules of the electrical terminal CPX, which can then be used for hybrid applications • Unique modular structure • Comprehensive integrated diagnostic and service functions • Analogue inputs and outputs with HART protocol 	<ul style="list-style-type: none"> • Accessories for the AS-Interface installation system • Compact I/O modules (IP65, IP67) 	<ul style="list-style-type: none"> • CPX-CTEL master module with 4 I-Port connections • Decentralised pneumatic components and sensors for fast processes • Standardised M12 connections
online: →	cpx-e	cpx-p	as-interface	cpx-ctel

Product overview

Customised components – for your specific requirements



Valve terminals with customised designs

Can't find the valve terminal you need in our catalogue?

We can offer you customised components that are tailored to your specific requirements.

Common product modifications:

- Coatings for special ambient conditions
- Customised cables: length, pin allocation, pre-assembled with plug
- Modified actuating elements
- Modified connecting thread
- Modified valve sub-bases

Many additional variants are possible.

Ask your Festo sales engineer, who will be happy to help you:

→ www.festo.com/contact



Product overview

Software tools

Configurator

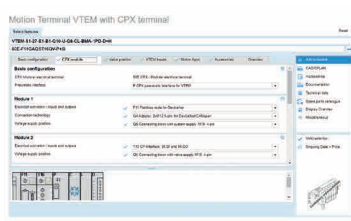

Design a product with numerous features reliably and quickly with the help of the configurator.

Select all the required product features step-by-step. The use of logic checks ensures that only correct configurations are available for selection.

You will find the configurator

- at www.festo.com/catalogue/vtem
- Click on the product
- Click on the blue “Configure product” button

Motion Terminal



Motion Terminal
VTEM

Valve terminal design	Fixed grid
Grid dimension	28 mm
Max. no. of valve positions	8
Valve function	Can be allocated using the Motion App
Standard nominal flow rate, exhaust 6->5 bar	480 l/min
Pneumatic connection 1	G3/8
Operating pressure [MPa]	0.3 ... 0.8 MPa
Operating pressure	3 ... 8 bar
Operating pressure [psi]	43.5 ... 116 psi
Note on operating pressure	0 - 8 bar with external pilot air, Vacuum operation at connection 3 only
Pilot pressure [MPa]	0.3 ... 0.8 MPa
Pilot pressure	3 ... 8 bar
Pilot pressure [psi]	43.5 ... 116 psi
Motion Apps	Leakage diagnostics, Flow control, ECO drive, Positioning, Proportional pressure regulation, Proportional directional control valve, Soft Stop, Presetting of travel time, Directional control valve functions, Selectable pressure head, Supply and exhaust air flow control, Model-based proportional pressure regulation
Actuation type	Electric
Nominal operating voltage DC	24 V
Temperature of medium	5 ... 50°C
Description	<ul style="list-style-type: none"> • Many functions for movement, pressure and flow in one component – thanks to apps • Maximum repeat accuracy thanks to digital parameter sets • Easy to trace – ideal for the Industry 4.0 • Easy to duplicate the parameters • Increased energy efficiency • Reduced complexity and time to market • Increasing profitability and know-how protection • Predictive maintenance • Minimal installation effort • Sustainable operation with pressure-reduced return stroke and leakage detection
online: →	vtem

Motion Apps

	 <p>Motion Apps GAMM</p>
Description	<ul style="list-style-type: none"> • Open and closed-loop control programs for valves VEVM • A new dimension in flexibility thanks to Motion Apps – a single valve with a wide range of different functions • Accelerated engineering processes • Short response times without the need to adapt the hardware • Reduced system complexity • Shorter time to market for your application
online: →	gamm

Product overview



Product overview

Software tools

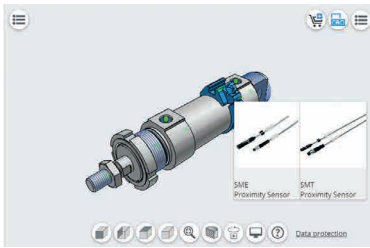

The Festo Design Tool 3D is a 3D product configurator for generating specific CAD product combinations from Festo.





The configurator makes your search for the right accessory easier, more reliable and faster.

You can then order the module that has been created as a single order item, either completely pre-assembled or as individual parts in a single box. This considerably reduces your bill of materials, and downstream processes such as product ordering, order picking and assembly are significantly simplified.

This tool can be found at
[→ www.festo.com/x/festo-design-tool](https://www.festo.com/x/festo-design-tool)





Proximity switches >

Proximity switches for T-slot

	 Proximity sensors SDBT-MSX	 Proximity sensors SMT-8M-A	 Proximity sensors SDBT-MSB	 Proximity sensors SDBT-BSW
Electrical connection				
Electrical connection, connection type	Cable, Cable with plug	Cable, Cable with plug	Cable, Cable with plug	Cable, Cable with plug
Electrical connection, connection technology	M8x1, A-coded, to EN 61076-2-104, Open end	M12x1, A-coded to EN 61076-2-101, M8x1, A-coded, to EN 61076-2-104, Open end	M8x1, A-coded, to EN 61076-2-104, Open end	M12x1, A-coded to EN 61076-2-101, Open end
Operating voltage range DC	10 ... 30 V	5 ... 30 V	10 ... 30 V	10 ... 30 V
Switching element function	N/C or N/O contact, switchable	N/C contact, N/C or N/O contact, switchable, N/O contact	N/O contact	N/O contact
Switching output	PNP/NPN, switchable	NPN, PNP, PNP/NPN, switchable, Non-contacting, 2-wire	NPN, PNP, Non-contacting, 2-wire	NPN, PNP, Non-contacting, 2-wire
NEW	<ul style="list-style-type: none"> • New product, 04/2022 			
Description	<ul style="list-style-type: none"> • Measuring principle: magnetic Hall • Auto teach-in: automatic teach-in of the switching point at system start-up • Programmable: PNP/NPN, NO/NC and switching window range between 2 ... 15 mm • Insertable in the slot from above, screw-clamped • LED status indicator • Cable length 0.3 ... 5 m 	<ul style="list-style-type: none"> • Measuring principle: magneto-resistive • For universal use • Individually configurable or pre-assembled • Inserted in the slot from above, flush with the cylinder profile • LED switching status indication • LED operating reserve indication • Cable length 0.1 ... 30 m 	<ul style="list-style-type: none"> • Measuring principle: magneto-resistive • Insertable in the slot from above, screw-clamped • LED switching status indication • Cable length 0.3, 2 m 	<ul style="list-style-type: none"> • Measuring principle: magneto-resistive • Welding field immune • Resistant to welding spatter • For contactless piston-rod position sensing on Festo pneumatic cylinders, in particular the hinge cylinder DW/DWA/DWB/DWC for AMI • Insertable in the slot from above, screw-clamped • LED switching status indication • Cable length 0.3 ... 5 m
online: →	sdbt	smt-8m	sdbt	sdbt

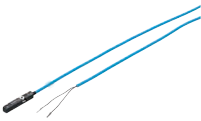
Proximity switches >



Proximity switches for T-slot

	 Proximity sensors SDBT-MS-EX6	 Proximity sensors SMT-8-SL	 Proximity sensors SMT-8-G	 Proximity sensors SMT-8-E
Electrical connection				
Electrical connection, connection type	Cable	Plugs	Cable, Cable with plug	Plugs
Electrical connection, connection technology	Open end	M8x1, A-coded, to EN 61076-2-104	M8x1, A-coded, to EN 61076-2-104, Open end	M12x1, A-coded to EN 61076-2-101, M8x1, A-coded, to EN 61076-2-104
Operating voltage range DC	7.5 ... 18 V	10 ... 30 V	10 ... 30 V	10 ... 30 V
Switching element function	NAMUR	N/O contact	N/O contact	N/O contact
Switching output	NAMUR	PNP	NPN, PNP	NPN, PNP
Description	<ul style="list-style-type: none"> Measuring principle: magneto-resistive To EU Explosion Protection Directive (ATEX) Insertable in the slot from above, screw-clamped LED switching status indication 	<ul style="list-style-type: none"> Measuring principle: magneto-resistive SMT-8-SL: sturdy thanks to long guides and plug directly on the sensor Insertable in the slot lengthwise or from above LED switching status indication Cable length 0.3, 2.5, 5 m 	<ul style="list-style-type: none"> Measuring principle: magneto-resistive SMT-8-G: design ideal for gripper sensing Insertable in the slot lengthwise or from above LED switching status indication Cable length 0.3, 2.5, 5 m 	<ul style="list-style-type: none"> Measuring principle: magneto-resistive Sturdy sensor in block design Plug integrated in housing LED switching status indication Inserted in the slot from above
online: →	sdbt	smt-8	smt-8G	smt-8E

Product overview



Proximity switches >

Proximity switches for T-slot

	 Proximity sensors CRSMT-8M	 Proximity sensors SMPO-8E	 Proximity sensors SMTSO-8E
Electrical connection			
Electrical connection, connection type	Cable, Cable with plug		Plugs
Electrical connection, connection technology	M12x1, A-coded to EN 61076-2-101, M8x1, A-coded, to EN 61076-2-104, Open end		M12x1, A-coded to EN 61076-2-101
Operating voltage range DC	5 ... 30 V		10 ... 30 V
Switching element function	N/O contact		N/O contact
Switching output	PNP		NPN, PNP
Description	<ul style="list-style-type: none"> Measuring principle: magneto-resistive Corrosion-resistant design Food-safe (see www.festo.com/certificates/CRSMT_8M), resistant to acids and cooling lubricants Inserted in the slot from above, flush with the cylinder profile LED switching status indication Cable length 0.3, 5 m, 10 m 	<ul style="list-style-type: none"> Measuring principle: magnetic Pneumatic proximity sensor Function: 3/2-way valve, normally closed Pneumatic connection via female thread M5 Visual switching status indication 	<ul style="list-style-type: none"> Measuring principle: magneto-inductive Welding field resistant design Sturdy sensor in block design Inserted in the slot from above Plug integrated in housing LED switching status indication
online: →	crsmt-8m	smpo	smtso

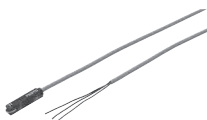

Proximity switches >

Proximity switches for T-slot

	 Proximity switch SME-8M	 Proximity switch SME-8	 Proximity sensors SMEO-8E
Electrical connection			
Electrical connection, connection type	Cable, Cable with plug	Cable, Plugs	Cable, Plugs
Electrical connection, connection technology	M12x1, A-coded to EN 61076-2-101, M8x1, A-coded, to EN 61076-2-104, Open end	M8x1, A-coded, to EN 61076-2-104, Open end	M12x1, A-coded to EN 61076-2-101, M8x1, A-coded, to EN 61076-2-104, Open end
Operating voltage range DC	5 ... 30 V	0 ... 230 V	0 ... 250 V
Switching element function	N/C contact, N/O contact	N/C contact, N/O contact	N/O contact
Switching output	Contacting, bipolar	Contacting, bipolar, Without LED function	Contacting, Contacting, bipolar, Without LED function
Description	<ul style="list-style-type: none"> Measuring principle: magnetic reed Individually configurable or pre-assembled Inserted in the slot from above, flush with the cylinder profile LED switching status indication Cable length 0.3, 2.5, 5, 7.5, 0.2 ... 10 m 	<ul style="list-style-type: none"> Measuring principle: magnetic reed Insertable in the slot lengthwise LED switching status indication Cable length 0.3, 2.5, 5, 7.5, 0.2 ... 10 m 	<ul style="list-style-type: none"> Measuring principle: magnetic reed Sturdy sensor in block design Plug integrated in housing Mounting with accessories LED switching status indication Cable length 2.5 m
online: →	sme-8m	sme-8	smeo

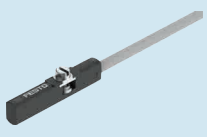

Proximity switches >

Proximity switches for round slot

	 Proximity sensor SDBC-MSB	 Proximity switch SMT-10M	 Proximity switch SMT-10G
Electrical connection			
Electrical connection, connection type	Cable, Cable with plug	Cable, Cable with plug	Cable, Cable with plug
Electrical connection, connection technology	M8x1, A-coded, to EN 61076-2-104, Open end	M12x1, A-coded to EN 61076-2-101, M8x1, A-coded, to EN 61076-2-104, Open end	M8x1, A-coded, to EN 61076-2-104, Open end
Electrical connection, number of pins/wires	2, 3	2, 3	3
Operating voltage range DC	10 ... 30 V	5 ... 30 V	10 ... 30 V
Switching element function	N/O contact	N/O contact	N/O contact
Switching output	NPN, PNP, Non-contacting, 2-wire	NPN, PNP, Non-contacting, 2-wire	NPN, PNP
NEW	<ul style="list-style-type: none"> • New product, 5/2021 		
Description	<ul style="list-style-type: none"> • Measuring principle: magneto-resistive • Insertable in the slot from above, screw-clamped • LED switching status indication • Cable length 0.3, 2 m 	<ul style="list-style-type: none"> • Measuring principle: magneto-resistive • For universal use • Individually configurable or pre-assembled • Inserted in the slot from above, flush with the cylinder profile • LED switching status indication • Cable length 0.3, 2.5 m 	<ul style="list-style-type: none"> • Measuring principle: magneto-resistive • SMT-10G: design ideal for gripper sensing • Insertable in the slot lengthwise or from above • LED switching status indication • Cable length 0.3, 2.5 m
online: →	sdbc	smt-10M	smt-10

Proximity switches >



Proximity switches for round slot

	 Proximity switch SME-10M	 Proximity switch SME-10
Electrical connection		
Electrical connection, connection type	Cable, Cable with plug	Cable, Cable with plug
Electrical connection, connection technology	M12x1, A-coded to EN 61076-2-101, M8x1, A-coded, to EN 61076-2-104, Open end	M8x1, A-coded, to EN 61076-2-104, Open end
Electrical connection, number of pins/wires	2, 3	3
Operating voltage range DC	5 ... 30 V	12 ... 27 V
Switching element function	N/O contact	N/O contact
Switching output	Contacting, bipolar	Contacting, bipolar
Description	<ul style="list-style-type: none"> • Measuring principle: magnetic reed • Individually configurable or pre-assembled • Inserted in the slot from above, flush with the cylinder profile • LED switching status indication • Cable length 0.3, 2.5 m 	<ul style="list-style-type: none"> • Measuring principle: magnetic reed • Insertable in the slot lengthwise • LED switching status indication • Cable length 0.3, 2.5 m
online: →	sme-10m	sme-10

Product overview



Proximity switches >

Proximity switches with block design

			
	Proximity sensors SMT-C1	Proximity sensors SME-1	Proximity sensors SMEO-1
Electrical connection	3-wire, 3-pin, Cable, Cable with plug, Rotatable thread, M8x1, M12x1		
Operating voltage range DC	10 ... 30 V	0 ... 200 V	0 ... 200 V
Switching element function	N/O contact	N/O contact	N/O contact
Switching output	PNP	Contacting, bipolar	Contacting, bipolar
Description	<ul style="list-style-type: none"> Measuring principle: magneto-inductive Easy-to-clean design Food grade see www.festo.com/certificates/SMT_C1 For clean design, standards-based cylinder DSBF with mounting rail for sensors LED switching status indication 	<ul style="list-style-type: none"> Measuring principle: magneto-inductive For mounting kit With or without LED switching status indication 	<ul style="list-style-type: none"> Measuring principle: magnetic reed SMEO-1-S6: heat-resistant design With or without LED switching status indication Cable length 2.5, 5 m
online: →	smt-c1	sme-1	smeo-1

Proximity switches >

Proximity switches with block design



			
	Proximity sensors SMTO-1	Proximity sensors SMTSO-1	Proximity sensors SMPO-1
Electrical connection			
Operating voltage range DC	10 ... 30 V	10 ... 30 V	
Switching element function	N/O contact	N/O contact	
Switching output	NPN, PNP	PNP	
Description	<ul style="list-style-type: none"> Measuring principle: magneto-resistive LED switching status indication Cable length 2.5 m 	<ul style="list-style-type: none"> Measuring principle: magneto-resistive Welding field resistant design LED switching status indication 	<ul style="list-style-type: none"> Measuring principle: magnetic Pneumatic proximity sensor Function: 3/2-way valve, normally closed Pneumatic connection via barbed fitting for tubing I.D. 3 mm Visual switching status indication
online: →	smto-1	smtso-1	smpo

Proximity switches >

Cylinder signal generators



	 <p>Cylinder signal generators PPL</p>
Standard nominal flow rate	48 l/min
Operating pressure [MPa]	0.1 ... 0.8 MPa
Operating pressure	1 ... 8 bar
Pneumatic connection	Barbed connector for 3 mm I.D. plastic tubing
Type of mounting	Hollow bolt G1/8, G1/4
Description	<ul style="list-style-type: none"> • For contactless pneumatic signal generation at the end of cylinder strokes • Function: 3/2-way valve, normally open • Can be screwed directly into the supply port of the cylinder using a hollow bolt
online: →	ppl

Inductive sensors

	 <p>Proximity switch SIEN</p>	 <p>Proximity switch SIED</p>	 <p>Proximity switch SIEF</p>
Size	4 mm, 6.5 mm, M12, M12x1, M18, M18x1, M30, M30x1.5, M5x0.5, M8x1	M12, M18, M30	40x40x65 mm, M12, M18, M30, M8
Switching output	NPN, PNP	Non-contacting, 2-wire	NPN, PNP
Switching element function	N/C contact, N/O contact	N/C contact, N/O contact	Antivalent, N/O contact
Electrical connection	3-wire, 3-pin, Cable, Plugs, M8x1, M12x1	2-wire, 2-pin, Cable, Plugs, M12x1	3-wire, 3-pin, 4-pin, Fixcon, Cable, Plugs, M8x1, M12x1
Operating voltage range DC	10 ... 30 V	10 ... 320 V	10 ... 65 V
Description	<ul style="list-style-type: none"> • With standard switching distance • For DC voltage • Round design • Metric thread • Flush or non-flush mounting • LED switching status indication • Design with metal or polyamide housing 	<ul style="list-style-type: none"> • With standard switching distance • For DC and AC voltage • Metric thread • Flush or non-flush mounting • LED switching status indication • Design with metal or polyamide housing 	<ul style="list-style-type: none"> • Reduction factor 1 for all metals • Welding field immune • Design with housing resistant to welding spatter • Flush, partially flush or non-flush mounting • LED switching status indication
online: →	sien	sied	sief

Product overview



Inductive sensors

			
	Proximity switch SIEH	Proximity switch SIES-Q	Proximity switch SIES-8M
Size	3 mm, M12, M18	8x8x59 mm, 12x26x40 mm, 15x20x30 mm, 40x40x120 mm, 5x5x25 mm, 8x8x40 mm	Slot 8
Switching output	NPN, PNP	NPN, PNP	NPN, PNP
Switching element function	N/C contact, N/O contact	Antivalent, N/C contact, N/O contact	N/C contact, N/O contact
Electrical connection	3-wire, 3-pin, Cable with plug, Plugs, M8x1, M12x1	3-wire, 3-pin, Cable, Screw terminal, Plugs, M8x1	
Operating voltage range DC	10 ... 30 V	10 ... 30 V	10 ... 30 V
Description	<ul style="list-style-type: none"> • With increased sensing distance • Flush mounting • Metric thread • LED switching status indication • Design with stainless steel housing 	<ul style="list-style-type: none"> • Block design • Flush mounting • LED switching status indication 	<ul style="list-style-type: none"> • Ideally suited for position sensing for electric axes and grippers with T-slot • Flush mounting • Switching status indication with 2 LEDs for better visibility regardless of the direction from which it is approached • Single inductive sensor for 8 slot with patented LED status indicator
online: →	sieh	sies	sies

Position sensors



			
	Position transmitters SDAT-MHS	Position transmitters SDAS-MHS	Position transmitter SMAT-8M
Design type	For T-slot	For T-slot	For T-slot
Sensing range	0 ... 160000 µm	≤52000 µm	52000 µm
Analogue output	0 - 10 V, 4 - 20 mA		0 - 10 V
Electrical connection, connection type	Cable with plug	Cable, Cable with plug	Cable with plug
Electrical connection, connection technology	M8x1, A-coded, to EN 61076-2-104	M8x1, A-coded, to EN 61076-2-104, Open end	M8x1, A-coded, to EN 61076-2-104
Electrical connection, occupied pins/wires	4	4	4
Electrical connection			
Description	<ul style="list-style-type: none"> • Measuring principle: magnetic Hall • Analogue output 0 ... 10 V or 4 ... 20 mA • Programmable IO-Link®/switching output • Insertable in the slot from above, screw-clamped • LED status indicator • Cable length 0.3 m • Suitable for T-slot 	<ul style="list-style-type: none"> • Measuring principle: magnetic Hall • IO-Link®, 2 programmable switching outputs • Inserted in the slot from above • Very compact design makes the unit especially well suited to work with grippers, compact cylinders and any application in a tight space • LED status indicator • Cable length 0.3, 2.5 m • Suitable for T-slot 	<ul style="list-style-type: none"> • Measuring principle: magnetic Hall • Analogue output 0 ... 10 V • Insertable in the slot from above, screw-clamped • Very compact design makes the unit especially well suited to work with grippers, compact cylinders and any application in a tight space • LED status indicator • Cable length 0.3 m • Suitable for T-slot
online: →	sdat	sdas	smat-8m

Position sensors

			
	Position sensors SRBS	★ Position sensors SMH-S1	Position transmitters SDAP-MHS
Design type	Round	For grippers	For T-slot
Sensing range	>270 deg		0 ... 160000 µm
Analogue output			4 - 20 mA
Electrical connection, connection type	Cable with plug	Cable with plug	Cable with plug
Electrical connection, connection technology	M8x1, A-coded, to EN 61076-2-104	M8x1, A-coded, to EN 61076-2-104	M8x1, A-coded, to EN 61076-2-104
Electrical connection, occupied pins/wires	4	4	4
Electrical connection			
Description	<ul style="list-style-type: none"> Used to detect rotation of the shaft on rotary drives DRVS and DSM Simple and reliable operation using just one pushbutton directly on the device Switching output 2x PNP or 2x NPN, switchable Sensor can be quickly mounted without having to manually search for switching points 	<ul style="list-style-type: none"> Measuring principle: magnetic Hall 3 gripper positions can be detected using an evaluation unit Freely selectable switching points 	<ul style="list-style-type: none"> Only for use with Festo Motion Terminal VTEM Measuring principle: magnetic Hall Insertable in the slot from above, screw-clamped LED status indicator Cable length 0.3 m Suitable for T-slot
online: →	srbs	smh-s1	sdap





Position sensors

Displacement encoders





			
	Displacement encoders MME-MTS-TLF	Displacement encoders MLO-POT-TLF	Displacement encoders MLO-POT-LWG
Stroke	225 ... 2000 mm	225 ... 2000 mm	100 ... 750 mm
Measuring principle of displacement encoder	Digital	Analogue	Analogue
Output signal	CAN protocol type SPC-AIF	Analogue	Analogue
Displacement resolution	<0.01 mm	0.01 mm	0.01 mm
Electrical connection	6-pin, Plugs, To DIN 45322, Round design	4-pin, Type A, Plugs, To DIN 43650, Square design	4-pin, Plugs, Square design, 16 mm
Description	<ul style="list-style-type: none"> Measuring principle: magnetostrictive Contactless with absolute measurement High travel speed System product for servo-pneumatic positioning technology and Soft Stop Degree of protection IP65 	<ul style="list-style-type: none"> Conductive plastic potentiometer Absolute measurement with high resolution High travel speed and long service life Plug-in connections 	<ul style="list-style-type: none"> Connecting rod potentiometer Absolute measurement with high resolution Long service life Degree of protection IP65 Plug-in connections
online: →	mme	mlo	mlo

Product overview

Pressure and vacuum sensors



	 Pressure sensors SDE5 ★	 Pressure sensors SPAN ★	 Pressure sensors SPAE	 Pressure sensors SPAU
Pressure measuring range [MPa]		-0.1 ... 1.6 MPa	-0.1 ... 1 MPa	
Pressure measuring range	-1 ... 10 bar	-1 ... 16 bar	-1 ... 10 bar	-1 ... 16 bar
Pressure measuring range [psi]		-14.5 ... 232 psi	-14.5 ... 145 psi	
Switching element function	N/C contact, N/O contact, Switchable	N/C or N/O contact, switchable	N/C contact, N/O contact, Switchable	N/C or N/O contact, switchable
Switching output	NPN, PNP	2 x PNP or 2 x NPN, switchable, PNP/NPN, switchable	PNP/NPN, switchable	2 x PNP or 2 x NPN, switchable, 2xPNP
Pneumatic connection	QS-1/4, QS-4, QS-5/32, QS-6	Male thread 1/8 NPT, Female thread G1/8, M5, For tubing O.D. 4 mm, Male thread G1/8, R1/8	Flange, Cartridge 10 mm, Push-in sleeve QS-4, QS-6, QS-3, QS-4	Flange, 1/8 NPT, G1/8, M5, M7, QS-4, QS-5/32, QS-6, R1/4, R1/8
Electrical connection	3-wire, 3-pin, Cable, Plugs, To EN 60947-5-2, Round design, M8x1	Plug 4-pin, square design	3-wire, Cable, Open end	
Display type		Illuminated LCD	LED indicator, 2-digit	Illuminated LCD, LED
Description	<ul style="list-style-type: none"> • Programmable and configurable pressure switch for simple pressure sensing tasks • Threshold/window comparator • Switching point adjustment via teach-in function • Integrated microprocessor • Switching status indicated by an LED visible from all sides • Certification: c UL us listed (OL), C-Tick 	<ul style="list-style-type: none"> • For monitoring compressed air and non-corrosive gases • For network monitoring, regulator monitoring, leak testing, object detection • Relative measurement method based on a piezoresistive measuring cell • Serial communication integrated using IO-Link® 1.1 • Compact design 30x30 mm • High-contrast display with blue backlight 	<ul style="list-style-type: none"> • Electronic pressure sensor with piezoresistive pressure measuring cell, integrated signal processing, numeric pressure indicator in percent, operating key and a switching output, PNP/NPN switchable • Display of minimum and maximum measured value • All parameters entered can be transferred to other SPAEs (replicating function) • Communication interface IO-Link® 	<ul style="list-style-type: none"> • For monitoring compressed air and non-corrosive gases • With or without display • Transfer of the pressure value as switching signal, analogue signal or via IO-Link® to the connected control system • Maximum versatility thanks to a wide range of pneumatic adaptations and switchable electrical outputs
online: →	sde5	span	spae	spau

Pressure and vacuum sensors



	 Pressure sensors SPAW	 Pressure sensors SDE3	 Pressure switches SPBA	 Pressure switches, vacuum switches PEV, VPEV
Pressure measuring range [MPa]				
Pressure measuring range	-1 ... 100 bar	-1 ... 10 bar		
Pressure measuring range [psi]				
Switching element function	Switchable	Switchable	Antivalent, Changeover switch	Changeover switch
Switching output	2xNPN, 2xPNP	2xNPN, 2xPNP	2xPNP, Contacting	
Pneumatic connection	Female thread G1/4, Male thread G1/2	QS-4, QS-5/32	G1/8	G1/4, G1/8, M5
Electrical connection		4-pin, 5-pin, Cable, Cable with plug, Plugs, To EN 60947-5-2, Round design, M8x1, M12x1	4-pin, Plugs, To EN 60947-5-2, Round design, M12x1	4-pin, Type A, Screw terminal, Plugs, To DIN 43650, To EN 60947-5-2, Round design, Square design, M8x1, M12x1
Display type	4-place alphanumeric, LED indicator	Illuminated LCD		
Description	<ul style="list-style-type: none"> Extremely sturdy For liquid and gaseous media Quick and easy adjustment of the switching outputs using three pushbuttons Optimal legibility: display housing rotatable 320°, display at an angle of 45° 	<ul style="list-style-type: none"> 5 pressure measuring ranges Measurement of relative or differential pressure or 2 independent supply ports Switching output 2x PNP or 2x NPN Numerical and graphical pressure indication Mounting: via H-rail, via wall/surface bracket, front panel mounting, with through-holes Certification: C-Tick, ATEX, c UL us Listed (OL) 	<ul style="list-style-type: none"> Pressure sensor with permanently set switching point For solenoid valve VSVA Mounting: screw-in 	<ul style="list-style-type: none"> Mechanical pressure and vacuum switch Adjustable switching point Mounting: screw-in, via through-holes or on an H-rail Visual scale for pressure adjustment Certification: CCC, c UL us – Recognized (OL), RCM
online: →	spaw	sde3	spba	pev

Product overview

Pressure and vacuum sensors



	 Pressure transmitters SPTe	 Pressure transmitters SPTW	 PE converters PEN, PE, VPE
Pressure measuring range [MPa]	-0.1 ... 1 MPa		
Pressure measuring range	-1 ... 10 bar	-1 ... 100 bar	
Pressure measuring range [psi]	-14.5 ... 145 psi		
Switching element function			N/O contact, Changeover switch
Switching output			PNP, Contacting
Pneumatic connection	Flange, Cartridge 10 mm, Push-in sleeve QS-4, QS-6, QS-3, QS-4	G1/4	G1/8, M5, PK-4
Electrical connection	3-wire, Cable, Open end		3 connector leads, 3-wire, 4-wire, Cable, Open end
Display type			
Description	<ul style="list-style-type: none"> • Piezoresistive pressure sensor • Measured variable: relative pressure • Cable length 2.5 m • Compact: 8-bracket wall mount for manifold mounting 	<ul style="list-style-type: none"> • Sensor versions: piezoresistive pressure sensor or metal thin-film pressure sensor • Measured variable: relative pressure • Operating medium: liquid media and gaseous media • Seal-free: pressure measuring cell and interfaces in stainless steel • Degree of protection IP67 	<ul style="list-style-type: none"> • Pneumatic/electric differential pressure switch • Pneumatic/electric pressure transducer • Design for vacuum • Mounting via through-hole, on mounting frame 1n, on mounting frame 2n • Splash-proof design • Certification: CCC, RCM
online: →	spte	sptw	pen

Flow sensors





	 Flow transmitters SFTE	 Flow sensors SFAH	 Flow sensors SFAW
Flow measuring range	0 ... 10 l/min	0.002 ... 200 l/min	1.8 ... 100 l/min
Operating medium	Nitrogen, Compressed air ISO 8573-1:2010 [6:4:4]	Argon, Nitrogen, Compressed air ISO 8573-1:2010 [6:4:4]	Liquid media, Water, Neutral fluids
Operating pressure	-0.9 ... 10 bar	-0.9 ... 10 bar	0 ... 12 bar
Pneumatic connection	Female thread M5, For push-in connector O.D. 3 mm, 4 mm	Female thread G1/4, G1/8, For tubing O.D. 4 mm, 6 mm, 8 mm	
Switching output		2 x PNP or 2 x NPN, switchable	2 x PNP or 2 x NPN, switchable
Electrical connection, connection type	Cable, Cable with plug	Plugs	Plugs
Electrical connection, connection technology	M8x1, A-coded, to EN 61076-2-104, Open end	Connection pattern L1J, M8x1, A-coded, to EN 61076-2-104	M12x1, A-coded to EN 61076-2-101
Electrical connection			
Description	<ul style="list-style-type: none"> • Compact design • Universal flow detection • Simple installation • Reliable pick & place application for extremely small workpieces 	<ul style="list-style-type: none"> • Process air, compressed air, forming gas consumption and pneumatic object monitoring, handling ultra-small parts, leak test • Compact design 20x58 mm • Clear 2-line display • Mounting: H-rail mounting, wall or surface mounting, front panel mounting • Serial communication integrated using IO-Link® 1.1 	<ul style="list-style-type: none"> • Cooling circuit monitoring, leakage or line break monitoring, process water monitoring, fill level monitoring • Input connection: clamped terminal connection DN15, DN20, barbed hose fitting 13 mm, female thread G1/2, G3/4, G1, user-specific connection • With optional integrated temperature sensor • Connection to higher-level systems via 2 switching outputs, an analogue output and/or an IO-Link® interface • Certification: RCM, c UL us Listed (OL) • Rotatable display, 90° anticlockwise and 180° clockwise
online: →	sfte	sfah	sfaw

Product overview

Flow sensors





	 Flow sensors SFAB	 Flow sensors SFAM
Flow measuring range	0.1 ... 1000 l/min	10 ... 15000 l/min
Operating medium	Nitrogen, Compressed air ISO 8573-1:2010 [7:4:4], ISO 8573-1:2010 [6:4:4]	Nitrogen, Compressed air ISO 8573-1:2010 [7:4:4]
Operating pressure	0 ... 10 bar	0 ... 16 bar
Pneumatic connection	For tubing O.D. 1/4", 10 mm, 12 mm, 3/8", 5/16", 6 mm, 8 mm	Manifold module, 1/2 NPT, 1 NPT, 1 1/2 NPT, G1, G1 1/2, G1/2
Switching output	2 x PNP or 2 x NPN, switchable	2x PNP or 2x NPN adjustable
Electrical connection, connection type	Plugs	
Electrical connection, connection technology	M12x1, A-coded to EN 61076-2-101	
Electrical connection		5-pin, Straight plug, M12x1
Description	<ul style="list-style-type: none"> • Flow sensor with integrated digital display • With unidirectional flow input • Mounting: H-rail, wall or surface mounting • Certification: C-Tick • Sustainable operation with system consumption monitoring 	<ul style="list-style-type: none"> • Stand-alone device or combined with MS series service unit components • Supplies absolute flow information and accumulated air consumption measurements • Covers large measuring range with great precision thanks to high dynamic response • Large, illuminated LCD display
online: →	sfab	sfam

Opto-electrical sensors



				
	Retro-reflective sensors, diffuse sensors, light barriers SOOD	Retro-reflective sensors, diffuse sensors, distance sensor, light barriers SOOE	Sensors SOEG-RT, SOEG-RS	Through-beam sensors SOEG-E, SOEG-S
Method of measurement	Retro-reflective sensor, Through-beam sensor, Transmitter, Receiver, Diffuse sensor with background clipping	Retro-reflective sensor, Distance sensor, Through-beam sensor, Transmitter, Receiver, Diffuse sensor with background clipping, Laser contrast sensor, Retro-reflective sensor for transparent objects, Diffuse sensor	Retro-reflective sensor, Diffuse sensor, Diffuse sensor with background suppression	Through-beam sensor, Receiver, Transmitter
Working range	0 ... 10000 mm	0 ... 20000 mm	0 ... 2000 mm	20000 mm
Size			M12, M12x1, M18, M18x1	M18x1
Setting options		IO-Link®, Potentiometer, Teach-in	Potentiometer	
Type of light	Laser, Red, LED	Laser, Red, LED	Red, Red polarised	Red
Switching output	Push-pull	Push-pull	NPN, PNP	NPN, PNP
Description	<ul style="list-style-type: none"> • Simple operation • Fast commissioning • Reliable and stable detection • Attractive price/performance ratio 	<ul style="list-style-type: none"> • Simple operation • Fast commissioning • Reliable and stable detection • Attractive price/performance ratio 	<ul style="list-style-type: none"> • Round design • Electrical connection via open cable end or plug connector 	<ul style="list-style-type: none"> • Round design • Electrical connection via open cable end or plug connector
online: →	sood	sooe	soeg	soeg

Product overview

Opto-electrical sensors

	 Colour sensors SOEC	 Fibre-optic units SOE4	 Fork light barriers SOOF	 Fibre-optic cables SOEZ, SOOC
Method of measurement	Colour sensor	Fibre-optic unit	Fork light barrier	Through-beam sensor, Fork light barrier, Light guide, Diffuse sensor
Working range	12 ... 32 mm			5 ... 400 mm
Size	50x50x17 mm		Clevis 120x60 mm, 30x35 mm, 50x55 mm, 80x55 mm	M4, M6
Setting options	Teach-in, Teach-in via electrical connection	Teach-in, Teach-in via electrical connection	IO-Link®, Potentiometer, Teach-in	
Type of light	White	Red	Red	
Switching output	PNP	NPN, PNP	Push-pull, NPN, PNP	
Description	<ul style="list-style-type: none"> • Diffuse sensor • Block design • Electrical connection via M12x1 plug, 8-pin • Display via 7 LEDs 	<ul style="list-style-type: none"> • Use for precise and space-saving position sensing in the electronics and light assembly industry • Switching frequencies of up to 8000 Hz • Operational with fibre-optic cable SOOC as accessory • Variants: LED or LED display, timer function • Mounting: H-rail mounting or via through-holes • With protection against mutual interference 	<ul style="list-style-type: none"> • Through-beam sensor with minimal installation effort • Design: polymer or metal • Sturdy housing: high shock and vibration resistance • Degree of protection IP67 • Electrical connection via M8x1 plug connector, 3-pin • LED indicators 	<ul style="list-style-type: none"> • Cable connection, push-in connector
online: →	soec	soe4	soof	soez

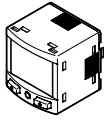
Signal converters





	 Signal converters SCDN	 Signal converters SVE4
Signal range	0 - 10 V, 0 - 20 mA	Adapted for position sensors SMH-S1-HG, 0 - 10 V +/-0.3 V, 0 - 20 mA +/-0.6 mA
Switching output	2 x PNP or 2 x NPN, switchable	2xNPN, 2xPNP
Switching function	Freely programmable	Freely programmable
Electrical connection input		
Electrical connection, connection type	Plugs	
Electrical connection, connection technology	Connection pattern L1J	
Electrical connection, number of pins/wires	4	4
Electrical connection output		
Electrical connection 2, connection type	2x socket	
Electrical connection 2, connection technology	Connection pattern EC	
Electrical connection 2, number of pins/wires	4	4
Description	<ul style="list-style-type: none"> Converts analogue signals into IO-Link® signals Switching function freely programmable with teach-in Mounting: wall or surface mounting, front panel mounting, manifold mounting using mounting brackets Large, illuminated LCD display 	<ul style="list-style-type: none"> Converts analogue signals into switching points Switching function freely programmable with teach-in Threshold value, hysteresis or window comparator Mounting: H-rail mounting or via adapter plate LED switching status indication Certification: c UL us listed (OL), C-Tick
online: →	scdn	sve4

Electromechanical switches

	 Micro switches S-3
Description	<ul style="list-style-type: none"> Electric limit switch N/C contact, N/O contact, changeover switch Actuator attachments: roller lever type AR, one-way roller lever type AL, whisker actuator type AF
online: →	s-3

Product overview

Air gap sensors

	 Air gap sensors SOPA	 Micro reflex sensors, reflex sensors RML, RFL	 Back pressure end stops SD-2, SD-3, SD-3-N	 Air barriers SFL, SML
Sensing range	20 ... 200 µm	Distance between nozzles 4.8 ... 5.1 mm, 4.5 ... 15.5 mm	Distance between nozzles 0 ... 0.5 mm	Distance between nozzles 5 ... 50 mm, up to 100 mm
Operating pressure	4 ... 7 bar			
Display type	Illuminated LCD, multi-colour	Signaldruck ≥0.5 mbar	Pneumatic signal 0 ... 8 bar	Signal pressure
Operating medium	Compressed air ISO 8573-1:2010 [7:4:4]	Filtered, unlubricated compressed air	Filtered, lubricated or filtered, unlubricated compressed air	Filtered, unlubricated compressed air
Description	<ul style="list-style-type: none"> Convenient solution for high-precision contact and distance monitoring Setting option: IO-Link®, teach-in or numerical setting using three buttons Integrated air jet function Multi-coloured LCD display Mounting: H-rail mounting, wall mounting, through-hole Certification: C-Tick 	<ul style="list-style-type: none"> Back pressure actuated valve For contactless sensing of indicating instruments, checking pressing and stamping tools, edge control, magazine control, for measuring and counting Can be used even in very dirty environments, in complete darkness, with translucent or magnetic objects 	<ul style="list-style-type: none"> Can be used for stroke-dependent signal generation as a limit switch and fixed stop Ideal for end-position sensing and position control with high accuracy requirements and small actuating forces SD-3-N for sensing fluid levels and heavily foaming liquids For use in places that are difficult to access 	<ul style="list-style-type: none"> Sender nozzle, receiver nozzle, gap sensor Back pressure actuated valve Functional reliability even in very dirty environments Reliable even at high ambient temperatures Insensitive to mechanical influences and sound waves Reliable even in complete darkness and when sensing translucent objects
online: →	sopa	rfl	sd	sfl

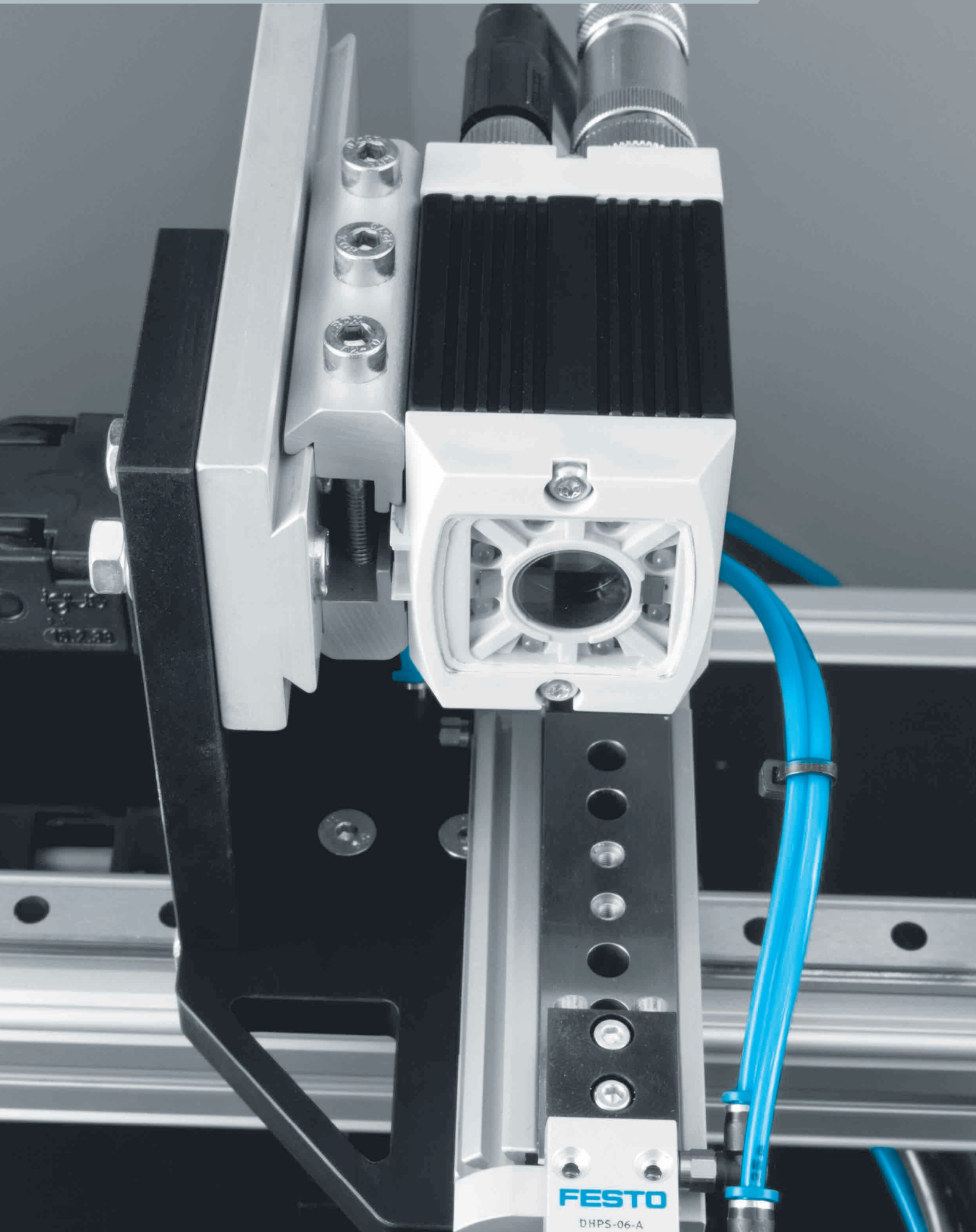

Product overview

Software tools

Camera Configuration Studio

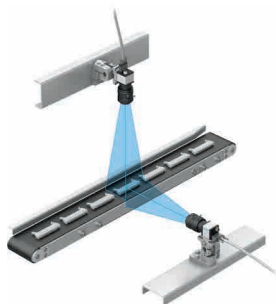

Machine vision engineering software for setting up, adjusting, displaying and logging inspection tasks of the camera system SBRD-Q

This tool can be found at

→ www.festo.com/x/engineering

Controllers



Controllers
SBRD-Q

Nominal operating voltage DC	24 V
Input/output interface, function	10x digital input, 2x digital inputs with integrated pull-up resistor, 8x digital output, Ground, Power supply
Camera interface, connection technology	USB 3.0 type A
Ethernet interface, protocol	TCP/IP
Ethernet interface, transmission rate	10 Mbit/s, 100 Mbit/s, 1000 Mbps
Storage capacity	32000000000 Byte
Description	<ul style="list-style-type: none"> • Space-saving controller with dual-core processor and PROFINET communication • Two camera interfaces for multi-camera tasks • Up to 256 test programs • Individual image recording and inspection or ongoing image recording and inspection • Detection of the position and the rotary orientation of parts, pick & place, quality inspection, measurement, reading barcodes, data matrix codes and optical characters (OCR) • Powerful image processing software for fast and reliable results
online: →	sbrd



Camera heads



Camera heads
SBPB

Sensor resolution	1600 x 1200 pixels (UXGA), 2456 x 2054 pixels (5MPix), 1280 x 1024 Pixels (SXGA)
Lens attachment	C mount
Sensor type	Colour, Monochrome
Frame rate (full image)	36, 60
Exposure time	Via mounting kit
Description	<ul style="list-style-type: none"> • High-quality, sturdy housing
online: →	sbpb

Accessories for vision systems

			
	Surface lights, ring lights SBAL	Mountings, mounting brackets, swivel mountings SBAM	Protective tubes SBAP
Type of mounting	Clamped in dovetail slot, Via mounting bracket, With accessories	Clamped, With through-hole, Via thread, Via dovetail slot	Via thread
Description	<ul style="list-style-type: none"> External lighting for camera head SBPB 	<ul style="list-style-type: none"> Assembly and mounting attachments for camera head SBPB 	<ul style="list-style-type: none"> To protect the sensor against external influences
online: →	sbal	sbam	sbap

Product overview



Product overview

Software tools

Air consumption



Calculate your system's air consumption quickly and conveniently. Simply enter all the drives and tubing, set the cycle times and working pressure and the air consumption per minute and per day will be calculated for you. It includes a feature for exporting the input table together with the result directly to Excel.

This tool can be found at
 → www.festo.com/x/air-consumption

Configurator

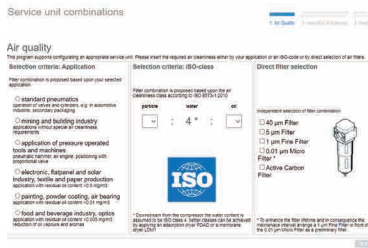

Design a product with numerous features reliably and quickly with the help of the configurator.





Select all the required product features step-by-step. The use of logic checks ensures that only correct configurations are available for selection.

A dynamic graphic generated on the basis of the configuration provides a visual aid for selecting the correct product features.

This tool can be found at
 → www.festo.com/x/service-unit-sizing

Service units >



MS series

				
	Service unit combinations MSB4, MSB6, MSB9 	Energy efficiency modules MSE6-E2M	Energy efficiency modules MSE6-D2M	Energy efficiency modules MSE6-C2M
Pneumatic connection 1	1/2 NPT, 3/4 NPT, 1 NPT, 1 1/4 NPT, 1 1/2 NPT, G1, G1 1/2, G1 1/4, G1/2, G1/4, G1/8, G3/4	G1/2	G1/2	G1/2
Standard nominal flow rate	750 ... 18000 l/min	4500 l/min	4500 l/min	7000 l/min
Flow measuring range		50 ... 5000 l/min	50 ... 5000 l/min	50 ... 5000 l/min
Pressure regulation range	0.5 ... 16 bar			
Operating pressure [MPa]		0.35 ... 1 MPa	0.35 ... 1.3 MPa	0.5 ... 1.1 MPa
Operating pressure	0 ... 20 bar	3.5 ... 10 bar	3.5 ... 13 bar	5 ... 11 bar
Grade of filtration	0.01 ... 40 µm			
Fieldbus interface		2x socket, M12x1, 4-pin, D-coded, 2x RJ45 push-pull socket, AIDA, 2x SCRJ push-pull socket, AIDA, Sub-D socket, 9-pin		2x RJ45 push-pull socket, AIDA
Description	<ul style="list-style-type: none"> • Combination of filter regulator, filter, lubricator, on/off valve, soft-start valve • Grid dimension 40, 62, 90 mm (size 4, 6, 9) 	<ul style="list-style-type: none"> • Intelligent service unit component for optimising the use of compressed air as an energy medium in industrial automation technology • Combination of stop valve, flow sensor, pressure sensor and fieldbus node • Identification of production downtime and leakages • User-controlled shut-off and pressurisation • Equipped with measurement, control and diagnostic functions • Fieldbus connection (PROFIBUS DP, PROFINET IO, EtherNet/IP or EtherCAT®) via integrated fieldbus nodes enables connection to a higher-level controller • Grid dimension 62 mm (size 6) • Sustainable operation with active air shut-off and pressure reduction 	<ul style="list-style-type: none"> • Intelligent service unit component for optimising the use of compressed air as an energy medium in industrial automation technology • Combination of flow sensor and stop valve with pressure sensor • Identification of production downtime and leakages • User-controlled shut-off and pressurisation • Equipped with measurement, control and diagnostic functions • Fieldbus connection (PROFINET IO) via the fieldbus node of the energy efficiency module MSE6-C2M-...-M actuated via the CPX extension or CPX terminal • Grid dimension 62 mm (size 6) • Sustainable operation with active air shut-off and pressure reduction 	<ul style="list-style-type: none"> • Intelligent service unit component for optimising the use of compressed air as an energy medium in industrial automation technology • Combination of fieldbus node, flow sensor, proportional pressure regulator and stop valve with pressure sensor • Identification of production downtime and leakages • User-controlled shut-off and pressure regulation • Configurable rise limit for setpoint pressure • Equipped with measurement, control and diagnostic functions • Fieldbus connection (PROFINET IO) via integrated bus nodes enables connection to a higher-level controller • Two digital inputs and outputs • Grid dimension 62 mm (size 6) • Sustainable operation with active air shut-off and pressure reduction
online: →	msb4	mse6	mse6	mse6

Product overview

Service units >

D series, polymer

	 Service unit combinations with lubricator FRC-K	 Service unit combinations without lubricator LFR-DB
Pneumatic connection 1	G1/4	G1/4
Standard nominal flow rate	400 ... 700 l/min	1900 l/min
Pressure regulation range	0.5 ... 7 bar	0.5 ... 7 bar
Operating pressure [MPa]	0.15 ... 1 MPa	0.15 ... 1 MPa
Operating pressure	1.5 ... 10 bar	1.5 ... 10 bar
Grade of filtration	40 µm	40 µm
Description	<ul style="list-style-type: none"> • Combination of on/off valve, filter regulator, distributor module and lubricator • Size mini 	<ul style="list-style-type: none"> • Combination of on/off valve, filter regulator and distributor module • Size mini
online: →	frc	lfr

Filter regulators/lubricators >

MS series

	 Service unit combinations MSB4-FRC, MSB6-FRC	★
Pneumatic connection 1	G1/2, G1/4, G1/8, G3/8	
Standard nominal flow rate	850 ... 4800 l/min	
Pressure regulation range	0.3 ... 12 bar	
Operating pressure	0.8 ... 20 bar	
Grade of filtration	5 µm, 40 µm	
Description	<ul style="list-style-type: none"> • Filter, regulator and lubricator functions in a single unit • High flow rate and highly efficient in removing contaminants • Good control characteristics with minimal pressure hysteresis • Grid dimension 40, 62 mm (size 4, 6) 	
online: →	msb4-frc	

Filter regulators/lubricators >

D series, polymer

	 <p>Service units FRC-DB</p>
Pneumatic connection 1	G1/4
Standard nominal flow rate	≥550 l/min
Pressure regulation range	0.5 ... 7 bar
Operating pressure [MPa]	0.15 ... 1 MPa
Operating pressure	1.5 ... 10 bar
Grade of filtration	5 µm, 40 µm
Description	<ul style="list-style-type: none"> • Filter, regulator and lubricator functions in a single unit • With manual or semi-automatic condensate drain • Size mini
online: →	frc

Filter regulators >

MS basic series

	 <p>Filter regulators MS2-LFR-B, MS4-LFR-B, MS6-LFR-B</p>	NEW
Pneumatic connection 1	G1/2, G1/4, M5, QS-6	★
Standard nominal flow rate	140 ... 5300 l/min	
Pressure regulation range [MPa]	0.03 ... 0.7 MPa	
Pressure regulation range	0.3 ... 7 bar	
Grade of filtration	5 µm, 40 µm	
Operating pressure [MPa]	0.1 ... 1 MPa	
Operating pressure	1 ... 10 bar	
NEW	<ul style="list-style-type: none"> • New product, 07/2021 	
Description	<ul style="list-style-type: none"> • Competitively priced basic component focused on the most important technical functions • Lightweight and sturdy thanks to modern polymer materials • Compatible with the MS series for the ideal combination of low-cost basic functionality and high-end functional requirements • Stable control response • With or without pressure gauge • Rotary knob with latch • With integrated secondary exhausting and primary exhausting with return flow function • MS2: Directly operated diaphragm regulator • MS4, MS6: directly actuated piston regulator • Grid dimension 25, 40, 62 mm (sizes 2, 4, 6) 	
online: →	ms2-lfr	

Product overview

Filter regulators >

MS series



Filter regulators
MS4-LFR, MS6-LFR, MS9-LFR, MS12-LFR



Pneumatic connection 1	Internal, G1/2, G1/4, G1/8, G3/8
Standard nominal flow rate	850 ... 24000 l/min
Pressure regulation range	0.3 ... 16 bar
Operating pressure	0.8 ... 20 bar
Grade of filtration	5 µm, 40 µm
Description	<ul style="list-style-type: none"> • MS4-LFR, MS6-LFR: directly actuated diaphragm regulator, MS9-LFR: piloted or directly actuated filter-diaphragm regulator, MS12-LFR: piloted diaphragm regulator without internal air consumption • Good control characteristics with minimal pressure hysteresis and primary pressure compensation • Good particle and condensate separation • With or without secondary exhausting • High flow rate • Lockable rotary knob • Return flow option for exhausting from output 2 to input 1 already integrated • Variants to EU Explosion Protection Directive (ATEX) • Grid dimension 40, 62, 90, 124 mm (size 4, 6, 9, 12) • With or without pressure gauge
online: →	ms4-lfr

Filter regulators >

D series, polymer



Filter regulators
LFR-DB

Pneumatic connection 1	G1/4
Standard nominal flow rate	≥1000 l/min
Pressure regulation range	0.5 ... 7 bar
Operating pressure [MPa]	0.15 ... 1 MPa
Operating pressure	1.5 ... 10 bar
Grade of filtration	5 µm, 40 µm
Description	<ul style="list-style-type: none"> • With manual or semi-automatic condensate drain • Size mini • With or without pressure gauge
online: →	lfr

Filter regulators >

D series, metal



Filter regulators
LFR-EX4

Pneumatic connection 1	G1/2, G1/4, NPT1/2-14, NPT1/4-18
Standard nominal flow rate	1150 ... 3400 l/min
Pressure regulation range	0.5 ... 16 bar
Operating pressure [MPa]	0.1 ... 2 MPa
Operating pressure	1 ... 20 bar
Grade of filtration	5 µm, 40 µm
Description	<ul style="list-style-type: none"> • Sturdy thanks to full metal design • High corrosion resistance (corrosion resistance class CRC 3 to Festo standard 940 070) and chemical resistance • Ambient temperature -40 ... +80 °C • Resistant to UV radiation and corrosive environments • With or without pressure gauge • Reliable manual drain • Energy efficient: excellent leakage values • Attractive price • To EU Explosion Protection Directive (ATEX) • Size: Midi
online: →	lfr

Filter regulators >

Individual devices







Filter regulators
PCRP

Pneumatic connection 1	1/4 NPT, 1/2 NPT, G1/2, G1/4, NPT1/2-14, NPT1/4-18
Standard nominal flow rate	1600 ... 4115 l/min
Pressure regulation range	0.5 ... 12 bar
Grade of filtration	5 µm, 40 µm
Operating pressure [MPa]	0.1 ... 2 MPa
Operating pressure	1 ... 20 bar
Description	<ul style="list-style-type: none"> • Robust housing for the specific requirements of the process automation industry • Suitable for use outdoors and at temperatures down to -60 °C • Resistant to UV radiation and corrosive environments • Two pressure gauge connections for different installation options • With manual condensate drain, rotating • Size 44, 64 • Sustainable operation thanks to reduced pressure level
online: →	pcrp

Product overview

Compressed air filters >

MS series

	 Filters MS4-LF, MS6-LF, MS9-LF, MS12-LF	 Fine filters MS4-LFM-B, MS6-LFM-B, MS9-LFM-B, MS12-LFM-B	 Micro filters MS4-LFM-A, MS6-LFM-A, MS9-LFM-A, MS12-LFM-A	 Activated carbon filters MS4-LFX, MS6-LFX, MS9-LFX, MS12-LFX
Pneumatic connection 1	Internal, G1/2, G1/4, G1/8, G3/8	Manifold module, 1/2 NPT, 3/4 NPT, 1 NPT, 1 1/4 NPT, 1 1/2 NPT, G1, G1 1/2, G1 1/4, G1/2, G1/4, G1/8, G3/4, G3/8	Manifold module, 1/2 NPT, 3/4 NPT, 1 NPT, 1 1/4 NPT, 1 1/2 NPT, G1, G1 1/2, G1 1/4, G1/2, G1/4, G1/8, G3/4, G3/8	Manifold module, 1/2 NPT, 3/4 NPT, 1 NPT, 1 1/4 NPT, 1 1/2 NPT, G1, G1 1/2, G1 1/4, G1/2, G1/4, G1/8, G3/4, G3/8
Standard nominal flow rate	1000 ... 16000 l/min			
Operating pressure	0 ... 20 bar	0 ... 20 bar	0 ... 20 bar	0 ... 20 bar
Grade of filtration	5 µm, 40 µm	0.01 µm, 1 µm	0.01 µm, 1 µm	0.01 µm, 1 µm
Description	<ul style="list-style-type: none"> • Good particle and condensate separation • High flow rate performance with minimal pressure drop • Available with manual, semi-automatic, fully automatic or fully automatic, electrically actuated condensate drain • Grid dimension 40, 62, 90, 124 mm (size 4, 6, 9, 12) 	<ul style="list-style-type: none"> • High-efficiency filter for exceptionally clean compressed air • Removing oil aerosols from compressed air • Optionally with differential pressure indicator for indication of contamination • Available with electronic filter contamination indicator • Grid dimension 40, 62, 90, 124 mm (size 4, 6, 9, 12) 	<ul style="list-style-type: none"> • High-efficiency filter for exceptionally clean compressed air • Removing oil aerosols from compressed air • Optionally with differential pressure indicator for indication of contamination • Available with electronic filter contamination indicator • Grid dimension 40, 62, 90, 124 mm (size 4, 6, 9, 12) 	<ul style="list-style-type: none"> • Removal of gaseous oil particles from compressed air using activated carbon • Air quality class at the output [1.4.1] to ISO 8573-1 • Eliminates odours and vapours • Residual oil content = 0.003 mg/m³ • Grid dimension 40, 62, 90, 124 mm (size 4, 6, 9, 12)
online: →	ms4-lf	ms4-lfm-b	ms4-lfm-a	ms4-lfx

Compressed air filters >

Individual devices

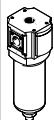
	 Filter silencers LFU	 Micro filters PFML
Size	G1/4, G3/8	90, 186
Grade of filtration	1 µm	0.01 µm
Operating pressure [MPa]	0 ... 1.6 MPa	0 ... 5 MPa
Operating pressure	0 ... 16 bar	0 ... 50 bar
Operating pressure [psi]	0 ... 232 psi	0 ... 725 psi
Flow rate with respect to atmosphere	4000 ... 12500 l/min	
Noise reduction	Reduction by 40 dB	
Description	<ul style="list-style-type: none"> • Removes up to 99.99% of oil and other contaminants from the exhaust air • Manual rotary condensate drain • Exhaust noise reduced regardless of frequency 	<ul style="list-style-type: none"> • For high-pressure applications • Food grade www.festo.com/certificates/PFML
online: →	lfu	pfml



Pressure regulators >

MS basic series

	 <p>Pressure regulators MS2-LR-B, MS4-LR-B, MS6-LR-B</p> <p style="text-align: right;">NEW</p>
Pneumatic connection 1	G1/2, G1/4, M5, QS-6
Standard nominal flow rate	170 ... 6000 l/min
Pressure regulation range	0.3 ... 7 bar
Operating pressure [MPa]	0.1 ... 1 MPa
Operating pressure	1 ... 10 bar
NEW	<ul style="list-style-type: none"> • New product, 07/2021
Description	<ul style="list-style-type: none"> • Competitively priced basic component focused on the most important technical functions • Lightweight and sturdy thanks to modern polymer materials • Compatible with the MS series for the ideal combination of low-cost basic functionality and high-end functional requirements • Stable control response • With or without pressure gauge • Rotary knob with latch • With integrated secondary exhausting and primary exhausting with return flow function • MS2: Directly operated diaphragm regulator • MS4, MS6: directly actuated piston regulator • Grid dimension 25, 40, 62 mm (sizes 2, 4, 6) • Sustainable operation thanks to reduced pressure level
online: →	ms-lr-b

Pressure regulators >



MS series

	 <p>Pressure regulators MS4-LR, MS6-LR, MS9-LR</p>	 <p>Pressure regulators MS12-LR</p>	 <p>Pressure regulators MS4-LRB, MS6-LRB</p>
Pneumatic connection 1	G1/2, G1/4, G1/8, G3/8	Sub-base	G1/2, G1/4
Standard nominal flow rate	1000 ... 30000 l/min	12000 ... 22000 l/min	300 ... 7300 l/min
Pressure regulation range	0.3 ... 16 bar	0.15 ... 16 bar	0.3 ... 16 bar
Operating pressure	0.8 ... 20 bar	0.8 ... 21 bar	0.8 ... 20 bar
Operating pressure [MPa]	0.1 ... 1 MPa		
Description	<ul style="list-style-type: none"> • High flow rate performance with minimal pressure drop • Good control characteristics with minimal pressure hysteresis and primary pressure compensation • With or without secondary exhausting • Lockable rotary knob • Optional pressure sensor and rotary knob pressure gauge • Grid dimension 40, 62, 90 mm (size 4, 6, 9) 	<ul style="list-style-type: none"> • High flow rate performance with minimal pressure drop • Good control characteristics with minimal pressure hysteresis and primary pressure compensation • With secondary exhausting • Lockable rotary knob • With or without pressure gauge • MS12-LR-...-PO: pneumatically actuated (pressure range determined by pilot regulator) • MS12-LR-...-PE6: electrically actuated (pilot control by proportional pressure regulator) • Grid dimension 124 mm (size 12) • Sustainable operation thanks to reduced pressure level 	<ul style="list-style-type: none"> • To build a regulator manifold with through air supply for pressure ranges that can be adjusted independently of one another • Good control characteristics with minimal pressure hysteresis and primary pressure compensation • Lockable rotary knob • With or without secondary exhausting • Integrated return flow option for exhausting from output 2 to input 1 • Optional pressure sensor and rotary knob pressure gauge • Variants to EU Explosion Protection Directive (ATEX) • Grid dimension 40, 62 mm (size 4, 6)
online: →	ms4-lr	ms12-lr	ms4-lrb

Product overview



Pressure regulators >

MS series

	 Precision pressure regulators MS6-LRP, MS6-LRPB	 Electrical pressure regulators MS6-LRE
Pneumatic connection 1	G1/2, G1/4, G3/8	G1/2, G1/4
Standard nominal flow rate	800 ... 5000 l/min	2200 ... 7500 l/min
Pressure regulation range	0.05 ... 12 bar	0.3 ... 16 bar
Operating pressure	1 ... 14 bar	0.8 ... 20 bar
Operating pressure [MPa]	0.1 ... 1.4 MPa	0.08 ... 2 MPa
Description	<ul style="list-style-type: none"> • As individual device and for manifold assembly • Manifold assembly with through air supply • Good control characteristics with minimal pressure hysteresis and primary pressure compensation • High secondary exhausting • Lockable rotary knob • Optional pressure sensor and rotary knob pressure gauge • Grid dimension 62 mm (size 6) 	<ul style="list-style-type: none"> • With integrated electric drive unit for remotely setting the outlet pressure • Constant output pressure even in the event of a power cut thanks to the fail-safe function • Available with control unit with display • Optional pressure sensor • With or without secondary exhausting • Grid dimension 62 mm (size 6)
online: →	ms6-lrp	ms6-lre



Pressure regulators >

D series, polymer

	 Pressure regulators LR-DB	 Pressure regulator manifolds LRB-DB
Pneumatic connection 1	G1/4	G1/2
Standard nominal flow rate	≥1300 l/min	≥1000 l/min
Pressure regulation range	0.5 ... 7 bar	0.5 ... 7 bar
Operating pressure [MPa]	0.1 ... 1 MPa	0.15 ... 1 MPa
Operating pressure	1.5 ... 10 bar	1.5 ... 10 bar
Description	<ul style="list-style-type: none"> • Setting values secured by locking the rotary knob • Available with pressure gauge • Size mini 	<ul style="list-style-type: none"> • Regulator manifold with through air supply for pressure ranges that can be adjusted independently of one another • Setting values secured by locking the rotary knob • Without pressure gauge • Size mini
online: →	lr-db	lrb-db

Pressure regulators >

Individual devices

		
	Precision pressure regulators LRP, LRPS	Electrical pressure regulators PREL
Pneumatic connection 1	For sub-base Ø 7 mm, G1/4, G1/8	G1
Standard nominal flow rate	240 ... 2300 l/min	
Pressure regulation range	0.05 ... 10 bar	0.4 ... 40 bar
Operating pressure [MPa]	0.1 ... 1.2 MPa	0 ... 5 MPa
Operating pressure	1 ... 12 bar	0 ... 50 bar
Description	<ul style="list-style-type: none"> • Lockable design • Good control characteristics with minimal pressure hysteresis and primary pressure compensation • High secondary exhausting • Variants to EU Explosion Protection Directive (ATEX) 	<ul style="list-style-type: none"> • For high-pressure applications • Food grade see www.festo.com/certificates/PREL • Size 90 mm, 186 mm
online: →	lrp	prel

Lubricators >



MS series

	
	Lubricators MS4-LOE, MS6-LOE, MS9-LOE, MS12-LOE
Pneumatic connection 1	Internal, G1/2, G1/4, G1/8, G3/8
Standard nominal flow rate	1100 ... 27000 l/min
Operating pressure	1 ... 16 bar
Minimum flow rate for lubricator function	40 ... 400 l/min
Description	<ul style="list-style-type: none"> • Proportional lubricator with precision oil metering • Quick and easy top-up even under pressure • Oil capacity 30 ... 1500 cm³ • Grid dimension 40, 62, 90, 124 mm (size 4, 6, 9, 12)
online: →	ms4-loe

Product overview



On/off and soft-start valves >

MS basic series

	 Soft-start valves MS4-EDE, MS6-EDE NEW	 On/off valves MS4-EE, MS6-EE NEW
Design	Poppet valve, electrically actuated	Poppet valve, electrically actuated
Pneumatic connection 1	G1/2, G1/4	G1/4
Operating pressure [MPa]	0.3 ... 0.7 MPa	0.3 ... 0.7 MPa
Operating pressure	3 ... 7 bar	3 ... 7 bar
Standard nominal flow rate	2000 ... 5000 l/min	2000 l/min
Exhaust air function	Without flow control option	
Electrical connection	Type C, To EN 175301-803	Type C, To EN 175301-803
NEW	<ul style="list-style-type: none"> • New product, 04/2022 	<ul style="list-style-type: none"> • New product, 04/2022
Description	<ul style="list-style-type: none"> • Very compact and extremely lightweight series for use close to the process directly in the machine • Electrically operated 3/2-way valve for slowly pressurising and exhausting pneumatic systems • The switching pressure can be precisely controlled with a solenoid valve • Adjustable switching time delay • Built-in connections into which the tubing can be directly inserted • Detenting and non-detenting manual override • Supply voltage 24 V DC • With solenoid coil, without plug socket • Grid dimension 40, 62 mm (size 4, 6) 	<ul style="list-style-type: none"> • Very compact and extremely lightweight series for use close to the process directly in the machine • Electrically operated 3/2-way valve for pressurising and exhausting pneumatic systems • Ducted exhaust air possible via threaded connection with silencer • Detenting and non-detenting manual override • Supply voltage 24 V DC • With solenoid coil, without plug socket • Grid dimension 40, 62 mm (size 4, 6)
online: →	ms-ed-e-b	ms-ee-b

On/off and soft-start valves >

MS series

			
	Soft-start/quick exhaust valves MS6-SV-E, MS6-SV-D	Soft-start/quick exhaust valves MS6-SV-C, MS9-SV-C	On/off valves MS4-EM1, MS6-EM1, MS9-EM, MS12-EM ★
Pneumatic connection 1	G1/2	G1/2	Manifold module, G1/2, G1/4, G1/8, G3/8
Standard nominal flow rate	4300 ... 5700 l/min	4300 ... 16550 l/min	1200 ... 32000 l/min
Operating pressure	3 ... 10 bar	3 ... 16 bar	0 ... 20 bar
Actuation type	Electric	Electric	Manual
Safety integrity level (SIL)	Exhaust/SIL 3, Prevention of unexpected start-up (pressurisation)/SIL 3		
Performance level (PL)	Exhaust/category 3, performance level d, Exhausting/up to category 4, performance level e, Prevention of unexpected start-up (pressurisation)/category 3, performance level d, Prevention of unexpected start-up (pressurisation)/up to category 4, performance level e	Exhausting/category 1, performance level c, Exhausting/up to category 1, performance level c, Prevention of unexpected start-up (pressurisation)/category 1, performance level c	
Description	<ul style="list-style-type: none"> • With safety functions • For reducing pressure quickly and reliably and for building up pressure gradually • Adjustable pressure build-up time • Available with silencer • Supply voltage 24 V DC • Grid dimension 62 mm (size 6) 	<ul style="list-style-type: none"> • With safety functions • For reducing pressure quickly and reliably and for building up pressure gradually • Adjustable pressure build-up time • Adjustable switch-through pressure • Supply voltage 24 V DC • Grid dimension 62, 90 mm (size 6, 9) 	<ul style="list-style-type: none"> • Manual 3/2-way valve for pressurising and exhausting pneumatic systems • A silencer can be attached or the exhaust air ducted at port 3 • Switching position is immediately recognisable • Optionally with pressure gauge and pressure sensor • Variants to EU Explosion Protection Directive (ATEX) • Grid dimension 40, 62, 90, 124 mm (size 4, 6, 9, 12)
online: →	ms6-sv-e	ms6-sv-c	ms4-em1

Product overview

On/off and soft-start valves >

MS series

	 On/off valves MS4-EE, MS6-EE, MS9-EE, MS12-EE ★	 Soft-start valves MS4-DL, MS6-DL, MS12-DL ★	 Soft-start valves MS4-DE, MS6-DE, MS12-DE
Pneumatic connection 1	Manifold module, G1/2, G1/4, G1/8, G3/8	Manifold module, G1/2, G1/4, G1/8, G3/8	Manifold module, G1/2, G1/4, G3/8
Standard nominal flow rate	1000 ... 32000 l/min	1000 ... 42000 l/min	1000 ... 42000 l/min
Operating pressure	3 ... 18 bar	2 ... 20 bar	3 ... 18 bar
Actuation type	Electric	Pneumatic	Electric
Safety integrity level (SIL)			
Performance level (PL)			
Description	<ul style="list-style-type: none"> • Electric 3/2-way valve for pressurising and exhausting pneumatic installations • A silencer can be attached or the exhaust air ducted at port 3 • Supply voltage 24 V DC, 110, 230 V AC • Optionally with pressure gauge and pressure sensor • With solenoid coil, without plug socket • Variants to EU Explosion Protection Directive (ATEX) • Grid dimension 40, 62, 90, 124 mm (size 4, 6, 9, 12) 	<ul style="list-style-type: none"> • 2/2-way valve for slowly pressurising pneumatic systems (for use with on/off valves EM(1) and EE) • For building up pressure gradually • Adjustable pressure build-up time • Variants to EU Explosion Protection Directive (ATEX) • Grid dimension 40, 62, 124 mm (size 4, 6, 12) 	<ul style="list-style-type: none"> • 2/2-way valve for slowly pressurising pneumatic installations with electrically switchable pressure switchover point • Supply voltage 24 V DC, 110, 230 V AC • Switchable pressure switching point • For advancing the drives slowly and reliably into the initial position • For avoiding sudden and unexpected movements • Adjustable pressure build-up time • Variants to EU Explosion Protection Directive (ATEX) • Grid dimension 40, 62, 124 mm (size 4, 6, 12)
online: →	ms4-ee	ms4-dl	ms4-de

On/off and soft-start valves >

D series, polymer

	 On/off valves HE-DB
Pneumatic connection 1	G1/4
Standard nominal flow rate	2300 l/min
Operating pressure [MPa]	0 ... 1 MPa
Operating pressure	0 ... 10 bar
Actuation type	Manual
Description	<ul style="list-style-type: none"> • 3/2-way shut-off valve • Switching position is immediately recognisable • Commercially available padlock for security
online: →	he-db

On/off and soft-start valves >

Individual devices

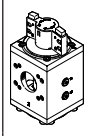
	 Shut-off valves HE-LO	 On/off valves PVEL
Pneumatic connection 1	G1, G1/2, G3/4, G3/8	
Standard nominal flow rate	5200 ... 10000 l/min	
Nominal size DN		54
Operating pressure [MPa]		0 ... 5 MPa
Operating pressure	1 ... 10 bar	0 ... 50 bar
Actuation type	Manual	Manual, Pneumatic
Description	<ul style="list-style-type: none"> • For shutting off the compressed air supply whilst simultaneously exhausting systems powered by compressed air • Can be locked in the closed position • Screwed into piping, through-holes for wall mounting • To OSHA 29 CFR 147 	<ul style="list-style-type: none"> • Food grade see www.festo.com/certificates/PVEL • For high-pressure applications
online: →	he-lo	pvel

Air dryers >

MS series

	 Membrane air dryers MS4-LDM1, MS6-LDM1
Pneumatic connection 1	G1/2, G1/4
Standard nominal flow rate	50 ... 400 l/min
Operating pressure	3 ... 12.5 bar
Pressure dew point reduction	Please refer to documentation in the Internet
Description	<ul style="list-style-type: none"> • Final dryer with excellent operational reliability • Suitable for use as an individual device or for integration into existing service unit combinations • Flow rate-dependent dew point reduction • Wear-free function requiring no external energy • Grid dimension 40, 62 mm (size 4, 6)
online: →	ms4-ldm1

Product overview



Air dryers >

Air dryers: individual devices

	 <p>Adsorption dryers PDAD</p>
Pneumatic connection 1	G1/2, G3/8
Inlet pressure 1	4 ... 16 bar
Pressure dew point	-40°C
Description	<ul style="list-style-type: none"> • Ideal for decentralised compressed air drying • Integrated filtering of oil and particulates • Defined pressure dew point • Low purge air consumption
online: →	pdad

Compressed air distributors >

MS series

	 <p>Branching modules MS4-FRM, MS6-FRM, MS9-FRM, MS12-FRM ★</p>		 <p>Distributor blocks MS4-FRM-FRZ, MS6-FRM-FRZ ★</p>
Pneumatic connection 1	G1/4, G1/2, G1, G2, Manifold module, 1/2 NPT, 3/4 NPT, 1 NPT, 1 1/4 NPT, 1 1/2 NPT, G1, G1 1/2, G1 1/4, G1/2, G1/4, G1/8, G3/4, G3/8		G1/4, G1/2
Standard nominal flow rate in main flow direction 1->2	1200 ... 50000 l/min		4050 ... 14600 l/min
Operating pressure	0 ... 20 bar		0 ... 20 bar
Description	<ul style="list-style-type: none"> • Optionally with integrated non-return function and pressure switch • Outlet at top and bottom • Can be used as an intermediate distributor for varying air qualities • Optionally with pressure sensor • Grid dimension 40, 62, 90, 124 mm (size 4, 6, 9, 12) 		<ul style="list-style-type: none"> • Slim compressed air distributor • Outlet at top and bottom • Can be used as an intermediate distributor for varying air qualities • Can be used as an adapter between two pressure regulators size 4 with pressure gauge with large rotary knob • Grid dimension 40, 62 mm (size 4, 6)
online: →	ms*-frm		ms*-frm-frz

Compressed air distributors >

Individual devices

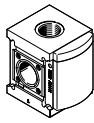

Branching modules
PMBL

Pneumatic connection 3	G1
Pneumatic connection 4	G1
Operating pressure [MPa]	0 ... 5 MPa
Operating pressure	0 ... 50 bar
Description	<ul style="list-style-type: none"> • For high-pressure applications • Food grade see www.festo.com/certificates/PMBL • Size 90 mm, 186 mm
online: →	pmb

Condensate drain >

MS series



Water separators
MS6-LWS, MS9-LWS, MS12-LWS

Pneumatic connection 1	G1/2, G1/4, G3/8
Operating pressure	0.8 ... 16 bar
Description	<ul style="list-style-type: none"> • No replacement of filter cartridges necessary • Constantly high condensate separation (99%) up to the maximum flow rate • Available with fully automatic or fully automatic, electrically actuated condensate drain
online: →	ms6-lws

Condensate drain >

Individual devices



Condensate drains, electrical
PWEA



Condensate drains, automatic
WA

Pneumatic connection	G1/2	M9
Operating pressure	0.8 ... 16 bar	1.5 ... 16 bar
Description	<ul style="list-style-type: none"> • Fully automatic condensate drain with independent electric controller • Interface available for communicating with master control device • Reliable thanks to contactless capacitive sensor • Can be used with service units or simply in piping systems • Ready status and switching status indicated via LEDs and electrical interface 	<ul style="list-style-type: none"> • For attaching to service units and compressed air networks/systems • Automatic emptying after the max. fill level has been reached • Automatic emptying after the operating pressure $p < 0.5$ bar is switched off • Manual actuation during operation is possible
online: →	pwea	wa

Product overview

Pressure amplifiers

Pressure boosters



Pressure boosters
DPA

Pneumatic connection 1	G1/2, G1/4, G3/8, QS-10, QS-12, QS-16
Outlet pressure 2	4 ... 16 bar
Inlet pressure 1	2 ... 10 bar
Description	<ul style="list-style-type: none"> • Pneumatic pressure increase up to double the input pressure • Available as pressure booster/air pressure reservoir combinations • Any mounting position • Short filling times • Long service life • Compact design • Available with sensing option
online: →	dpa

Pressure gauges



Pressure gauges
PAGN



Pressure gauges
MA





Flanged pressure gauges
FMA



Flanged precision pressure gauges, precision pressure gauges
FMAP, MAP

Type of mounting	In-line installation	In-line installation	Front panel mounting	Front panel mounting, In-line installation
Indicating range [MPa]	0 ... 1.6 MPa	0 ... 1.6 MPa		
Display range	0 ... 16 bar	0 ... 25 bar	0 ... 16 bar	0 ... 16 bar
Display range [psi]	0 ... 232 psi	0 ... 362.5 psi	0 ... 232 psi	0 ... 232 psi
Pneumatic connection	G1/8 with sealing ring, Cartridge 10 mm, G1/4, R1/8	G1/4, G1/8, M5, QS-4, QS-6, QS-8, R1/4, R1/8	G1/4	G1/4, R1/8
Operating pressure [MPa]	0 ... 1.6 MPa	0 ... 2.5 MPa	0 ... 1.6 MPa	0 ... 1.6 MPa
Operating pressure	0 ... 16 bar	0 ... 25 bar	0 ... 16 bar	0 ... 16 bar
Operating pressure [psi]	0 ... 232 psi	0 ... 362.5 psi	0 ... 232 psi	0 ... 232 psi
Measurement accuracy class	1.6, 2.5, 4, 5	1.6, 2.5, 4, 5	1.6, 2.5	1, 1.6
Description	<ul style="list-style-type: none"> • Designs based on EN 837-1 • Display units bar, psi, MPa 	<ul style="list-style-type: none"> • Designs based on DIN EN 837-1, available with red-green range • Pneumatic connection via R, G or metric thread, push-in connector • Display units bar, psi, MPa 	<ul style="list-style-type: none"> • Designs based on EN 837-1 • Pneumatic connection via G thread • Display units bar, psi 	<ul style="list-style-type: none"> • Designs based on EN 837-1 • Pneumatic connection via R or G thread • Display units bar, psi
online: →	pagn	ma	fma	fmap

Pressure gauges

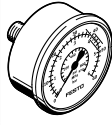
	 Pressure gauge kits DPA	 Vacuum gauges VAM, FVAM	 Pressure gauges PAGL
Type of mounting	Via male thread	Front panel mounting, Screw-in	In-line installation
Indicating range [MPa]			0 ... 6 MPa
Display range		-1 ... 9 bar	0 ... 60 bar
Display range [psi]		0 ... 130 psi	0 ... 870 psi
Pneumatic connection	G1/4, G1/8, R1/8	G1/4, G1/8, R1/4, R1/8	G1/4
Operating pressure [MPa]			0 ... 6 MPa
Operating pressure	10 ... 16 bar	-1 ... 9 bar	0 ... 60 bar
Operating pressure [psi]			0 ... 870 psi
Measurement accuracy class	2.5, 4	2.5	1.6
Description	<ul style="list-style-type: none"> • For pressure booster DPA • For monitoring the supply and output pressure • Pneumatic connection via R or G thread 	<ul style="list-style-type: none"> • Designs based on DIN EN 837-1, available with red-green range • Pneumatic connection via R or G thread • Double or single scale • Display units bar, in Hg, psi 	<ul style="list-style-type: none"> • For high-pressure applications • Display units bar, psi, MPa
online: →	dpa	vam	pagl

Customised components – for your specific requirements

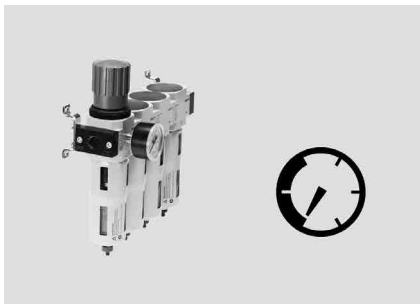

Components for compressed air preparation with customised designs

Can't find the compressed air preparation components you need in our catalogue?

We can offer you customised components that are tailored to your specific requirements.

Common product modifications:

- Modified pressure range
- Rotary knob: in a special colour, with protection against rotation
- Fitting: integrated throttling port, special thread
- Tubing with special printing
- Pressure gauge with red-green range

Many additional variants are possible.

Ask your Festo sales engineer, who will be happy to help you:

→ www.festo.com/contact

Product overview



Product overview

Software tools

Configurator for connecting cable NEBU



Design a product with numerous features reliably and quickly with the help of the configurator.





Select all the required product features step-by-step. The use of logic checks ensures that only correct configurations are available for selection.

A dynamic graphic generated on the basis of the configuration provides a visual aid for selecting the correct product features.

- You will find the configurator
- at www.festo.com/catalogue/nebu
 - Click on the product
 - Click on the blue “Configure product” button





Connecting cables >

Connecting cables, universal

	 Connecting cables NEBU	 Connecting cables NEBB	 Connecting cables/plug sockets with cable SIM	 Connecting cables KM12
Electrical connection, connection type	Socket, Cable, Plugs	Socket, Cable	Socket, Cable	Socket, Plugs
Electrical connection, cable outlet	Straight, Angled, Angled, can be aligned in increments of 15°	Straight, Angled	Straight, Angled	Straight
Electrical connection, design	Round	Round	Round	Round
Electrical connection, connection technology	G7/8 coded to NFPA/T3.5.29 R1-2007, M12x1, A-coded to EN 61076-2-101, M8x1, A-coded to EN 61076-2-104, Open end, M8x1, A-coded, to EN 61076-2-104	M12x1, A-coded to EN 61076-2-101, Open end, M8x1, A-coded, to EN 61076-2-104	M12x1, A-coded to EN 61076-2-101, Open end, M8 snap-locking A-coded to EN 61076-2-104	M12x1, A-coded to EN 61076-2-101
Electrical connection, number of pins/wires	3, 4, 5, 8	3, 4, 5	3, 4, 8	8
Cable length	0.1 ... 30 m	2.5 ... 10 m	2 ... 25 m	2 m
Description	<ul style="list-style-type: none"> • For thread M8x1 A-coded according to EN 61076-2-104 • For thread M12x1 A-coded according to EN 61076-2-101 • Pre-assembled at one or both ends • Designs for static, standard, energy chain and robot applications • Cable length 0.1 ... 30 m • With PVC or PUR cable • Ambient temperature -25 ... +80 °C 	<ul style="list-style-type: none"> • For thread M8x1 A-coded according to EN 61076-2-104 • For thread M12x1 A-coded according to EN 61076-2-101 • Pre-assembled at one end • With PVC cable • Ambient temperature -25 ... +70 °C 	<ul style="list-style-type: none"> • For thread M8 grid locking A-coded according to EN 61076-2-104 • For thread M12x1 A-coded according to EN 61076-2-101 • Pre-assembled at one end • With PVC or PUR cable • Ambient temperature -25 ... +80 °C 	<ul style="list-style-type: none"> • For thread M12x1 A-coded according to EN 61076-2-101 • Pre-assembled at both ends • With PUR cable • Ambient temperature -25 ... +80 °C
online: →	nebu	nebb	sim	km12

Connecting cables >

Connecting cables for control systems

	 Connecting cables NEBC ★	 Connecting cables NEBP	 Connecting cables NEBL ★	 Diagnostic cable SBOA
Electrical connection	25-pin, 5-pin, Straight plug, Straight plug connector/open at one end, Sub-D/-, Sub-D/Sub-D, Square design/angled, M12x1			
Electrical connection, connection type	Socket, Hybrid plug, Cable, Plugs, Plug and socket strip	Socket, Plugs	Socket, Cable, Plugs	
Electrical connection, cable outlet	Straight, Angled	Angled	Straight, Angled	
Electrical connection, design	Angular, Round	Round	Round	
Electrical connection, connection technology	Plug pattern P1, M12x1, A-coded to EN 61076-2-101, M12x1, Festo-specific coding, Plug pattern type A to EN 175301-803, HR25, M8x1, D-coded according to EN 61076-2-114, M12x1, D-coded to EN 61076-2-101, M9x0.5, RJ45 to IEC 60603-7-3, USB 2.0 type A, USB 3.0 type A, Open end, M8x1, A-coded, to EN 61076-2-104, RJ45, RJ45 and socket strip 12 pins, 2 rows, Sub-D, USB 2.0 type B, USB 3.0 type B micro	M9x0.5, M16x0.75	M8x1, A-coded to EN 61076-2-104, M12x1, T-coded according to EN 61076-2-111, Open end, M8x1, A-coded, to EN 61076-2-104	
Electrical connection, number of pins/wires	3, 4, 5, 8, 9, 10, 15, 17, 20, 25, 26	5, 6	4	
Cable length	0.2 ... 50 m	2 m	0.3 ... 15 m	
Description	<ul style="list-style-type: none"> • Variants in easy-to-clean design • Standard variants, variants with shielding or as a hybrid cable • Variants suitable for energy chains • Variants with Ethernet, CANopen, I-Port or RS232 	<ul style="list-style-type: none"> • Connection between displacement encoder MME and measuring module CPX-CMIX 	<ul style="list-style-type: none"> • For power supply • Suitable for use with energy chains 	<ul style="list-style-type: none"> • Ethernet diagnostic cable
online: →	nebc	nebp	nebl	sboa

Product overview

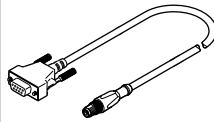

Connecting cables >

Connecting cables for motors

	 Motor, encoder, resolver cables NEBM	 Fieldbus adapters FBA
Electrical connection, connection type	Socket, Hybrid socket, Cable, Plugs, Plugs and cables	Socket, Plugs
Electrical connection, cable outlet	Straight, Angled	Straight
Electrical connection, design	Angular, Round	Angular, Round
Electrical connection, connection technology	Connection pattern F1, Connection pattern H6, coded for motor, Connection pattern H7, coded for motor brake, Connection pattern L4, Connection pattern L5, Connection pattern RE, ITT M3, M12x1, A-coded to EN 61076-2-101, RJ45, RJ45 and open end, Sub-D, Sub-D and open end, M16x0.75, M23x1, M40x1, Open end	M12x1, A-coded to EN 61076-2-101, Sub-D
Electrical connection, number of pins/wires	2, 4, 6, 8, 9, 12, 14, 15, 18, 21, 28, 31	5, 9
Cable length	0.2 ... 100 m	0.1 m
Description	<ul style="list-style-type: none"> • For servo motors EMMB-AS, EMME-AS, EMMT-AS and stepper motor EMMS-ST • For motor controllers CMMS-ST, CMMP-AS • Can be used in a wide temperature range • Suitable for use with energy chains 	<ul style="list-style-type: none"> • 9-pin Sub-D plug to 5-pin round plug/M12 socket • For CANopen and DeviceNet
online: →	nebm	fba

Connecting cables >

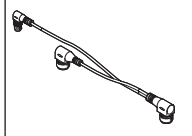

Connecting cables for valves

				
	Connecting cables/plug sockets with cable NEBV ★	Plug sockets with cable KMEB-1, KMEB-2, KMEB-3 ★	Plug sockets with cable KMF ★	Connecting cables NEDV
Electrical connection	4-pin/2-wire, 4-pin/3-pin, 44-pin, Socket, Angled socket/cable, Angled socket/straight plug connector, M8x1/M8x1, Sub-D, M8x1	4-pin, 5-pin, Angled socket, Type C, To DIN EN 175301-803	Socket	
Electrical connection, connection type	2x single wires, Socket, Socket, narrow, Cable with socket, Cable, Plugs, Twin wire	Socket		
Electrical connection, cable outlet	Straight, Angled	Angled		
Electrical connection, design	Angular, Round	Angular		
Electrical connection, connection technology	Connection pattern ZB, self-tapping screw, Connection pattern ZC, self-tapping screw, Plug pattern ZC, metric screw, Connection pattern H, Connection pattern HP, Connection pattern Q7, M12x1, A-coded to EN 61076-2-101, Connection pattern S, Connection pattern type A based on EN 175301-803, Plug pattern type B to industry standard, 11 mm, Plug pattern type C to EN 175301-803, M8x1, A-coded to EN 61076-2-104, Open end, Sub-D	Open end		
Electrical connection, number of pins/wires	2, 3, 4, 5, 8, 10, 25, 26, 27, 36, 37, 44	2, 3		
Cable length	0.1 ... 30 m	0.5 ... 10 m	2.5 ... 10 m	0.2 m
Description	<ul style="list-style-type: none"> • For solenoid coils form A, form B or form C • For solenoid coils with thread M8x1 or M12x1 A-coded • For solenoid coils ZC or various special connection patterns • Pre-assembled at one or both ends • Cable length 0.1 ... 30 m • With PUR cable • Ambient temperature -25 ... +80 °C 	<ul style="list-style-type: none"> • For solenoid coils with plug pattern type C according to EN 175301-803 • For EB solenoid coils • With PVC or PUR cable • Ambient temperature -20 ... +80 °C 	<ul style="list-style-type: none"> • For solenoid coils with plug pattern type B as per industrial standard, 11 mm • For F solenoid coils • With PVC cable • Ambient temperature -20 ... +80 °C 	<ul style="list-style-type: none"> • For proportional valves VPWP • For connecting to sub-base VABP-S3 • Pre-assembled • With PUR cable • Ambient temperature -25 ... +80 °C
online: →	nebv	kmeb-1	kmf	nedv

Product overview

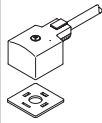
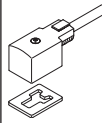

Connecting cables >

Connecting cables for valves

	 Connecting cables/plug sockets with cable KMYZ-2, KMYZ-4	 Plug sockets with cable KME	 Connecting cables KMC	 Plug sockets with cable KMV
Electrical connection	2-pin/2-wire, 2-pin/3-pin, Angled socket/cable, Angled socket/straight plug connector, Angled socket, Cable, Square design/M8x1, Square design/open end, Square design MSZB, Square design MSZC		Socket, Type A	Socket, Type B
Electrical connection, connection type				
Electrical connection, cable outlet				
Electrical connection, design				
Electrical connection, connection technology				
Electrical connection, number of pins/wires				
Cable length	0.5 ... 10 m	2.5 ... 10 m	2.5 ... 10 m	2.5 ... 10 m
Description	<ul style="list-style-type: none"> • For solenoid coils with plug pattern ZB • For solenoid coils with plug pattern ZC • With PVC or PUR cable • Ambient temperature -10 ... +50 °C 	<ul style="list-style-type: none"> • For solenoid coils with plug pattern type C as per industrial standard, 9.4 mm • For E solenoid coils • With PVC cable • Ambient temperature -20 ... +80 °C 	<ul style="list-style-type: none"> • For solenoid coils with plug pattern type A according to EN 175301-803 • For D solenoid coils • For N1 solenoid coils • With PVC cable • Ambient temperature -20 ... +80 °C 	<ul style="list-style-type: none"> • For solenoid coils with plug pattern type B according to EN 175301-803 • For V solenoid coils • With PVC cable • Ambient temperature -20 ... +80 °C
online: →	kmyz-2	kme	kmc	kmv



Connecting cables >

Connecting cables for valves

	 Connecting cables KRP	 Electrical plug-in bases MHAP-PI	 Plug sockets with cable KMPPE
Electrical connection	2-pin, Angled socket	2-pin, Socket	
Electrical connection, connection type			Socket, Cable
Electrical connection, cable outlet			Angled
Electrical connection, design			Round
Electrical connection, connection technology			M16x0.75 to EN 61076-2-106, Open end
Electrical connection, number of pins/wires			8
Cable length	2.5 ... 5 m	0.5 ... 1 m	2.5 ... 5 m
Description	<ul style="list-style-type: none"> For solenoid coil with plug pattern ZC, self-tapping screw Pre-assembled With PVC cable Ambient temperature -10 ... +50 °C 	<ul style="list-style-type: none"> Electrical plug-in base with plug pattern H For sub-base valves and semi in-line valves MHA1-...-PI and MHP1-...-PI Pre-assembled Ambient temperature -20 ... +80 °C 	<ul style="list-style-type: none"> For solenoid coils with thread M16x0.75 For proportional pressure regulators MPPE/MPPEs With PVC cable Ambient temperature -30 ... +80 °C
online: →	krp	mhap	kmppe

Connecting cables >



Connecting cables for valves

	 Connecting/plug sockets with cable KMPYE-AIF, KMPYE-5	 Connecting cables MHJ9-KMH
Electrical connection		2-pin/2-pin/4-wire, Straight socket/straight socket/cable
Electrical connection, connection type	Socket, Cable, Plugs	
Electrical connection, cable outlet	Straight	
Electrical connection, design	Round	
Electrical connection, connection technology	M12x1, A-coded to EN 61076-2-101, M9x0.5, Open end	
Electrical connection, number of pins/wires	4, 7	
Cable length	0.3 ... 5 m	0.5 ... 2.5 m
Description	<ul style="list-style-type: none"> For solenoid coils with thread M12x1 A-coded according to EN 61076-2-101 For connecting proportional directional control valves MPYE with end-position controller SPC11 Cable length 0.3 ... 5 m With PVC or PUR cable Ambient temperature -25 ... +80 °C 	<ul style="list-style-type: none"> With control electronics for solenoid valves MHJ9 With plug sockets KMH With PVC cable Ambient temperature -5 ... +50 °C
online: →	kmpye	mhj9-kmh

Product overview



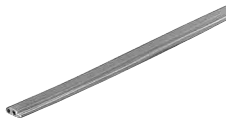

Connecting cables >

Connecting cables for valve terminals

	 Connecting cables NEBVS1	 Flat cables KASI	 Addressing cables KASI-ADR	 Connecting cables KMP3, KMP4, KMP6
Electrical connection	44-pin, Socket, Sub-D			
Electrical connection, connection type	Socket, Cable		Socket	Socket, Cable
Electrical connection, cable outlet	Straight, Angled		Straight, Angled	Straight, Angled
Electrical connection, design	Angular		Angular, Round	Angular
Electrical connection, connection technology	Open end, Sub-D		AS-Interface, M12x1, A-coded to EN 61076-2-101	Open end, Sub-D
Electrical connection, number of pins/wires	10, 25, 26, 27, 37, 44		2, 4	9, 10, 15, 18, 20, 25, 26
Cable length	2.5 ... 10 m	100 m		1 ... 99 m
Description	<ul style="list-style-type: none"> • For multi-pin plug connection Sub-D • Connecting cable between valve terminal and controller • Variants in easy-to-clean design • With PVC or PUR cable • Pre-assembled at one end • Ambient temperature -5 ... +50 °C 	<ul style="list-style-type: none"> • For AS-Interface • Reverse polarity protected • Contact using insulation displacement technology • No need to strip cable and wire insulation • Two different colours: yellow (preferred for the AS-Interface® network) and black (for auxiliary power supply) 	<ul style="list-style-type: none"> • For AS-Interface • For any slaves such as individual valve interface, valve terminal with AS-Interface® connection • Reverse polarity protected 	<ul style="list-style-type: none"> • For multi-pin plug connection Sub-D • Connecting cable between valve terminal and controller • Pre-assembled • With PVC or PUR cable • Ambient temperature -40 ... +70 °C
online: →	nebv	kasi	kasi-adr	kmp

Connecting cables >



Connecting cables for valve terminals

				
	Connecting cables KV-M12	Connecting cables KMPV-SUB	Connecting cables KVI	Connecting cables VMPA-KMS1, VMPA-KMS2, VMPAL-KM, VMPAL-KMSK
Electrical connection		15-pin, Socket, Sub-D		Cable with plug
Electrical connection, connection type	Socket, Plugs		Socket, Plugs	Socket, Cable
Electrical connection, cable outlet	Straight		Straight, Angled	Angled
Electrical connection, design	Round		Round	Angular
Electrical connection, connection technology	M12x1, A-coded to EN 61076-2-101		M9x0.5	Open end, Sub-D
Electrical connection, number of pins/wires	5		5	10, 25
Cable length	1.5 ... 3.5 m	5 ... 10 m	0.25 ... 8 m	2.5 ... 10 m
Description	<ul style="list-style-type: none"> • Plug socket with cable for diagnostic interface (to CPX terminal) • Pre-assembled at both ends • With PUR cable • Ambient temperature -25 ... +70 °C 	<ul style="list-style-type: none"> • For multi-pin plug connection Sub-D • Pre-assembled at one end • With PUR cable • Ambient temperature -20 ... +80 °C 	<ul style="list-style-type: none"> • For fieldbus connection with thread M9x0.5 • Connecting cable between valve terminal and controller • Connecting cable between valve terminal and input/output modules • Connecting cable between controller and input/output modules • Pre-assembled at both ends • Suitable for use with energy chains • With PUR cable • Ambient temperature -20 ... +80 °C 	<ul style="list-style-type: none"> • For multi-pin plug connection Sub-D • Connecting cable between valve terminal MPA and controller • Variants suitable for energy chains • Pre-assembled at one end • With PVC or PUR cable • Ambient temperature -40 ... +80 °C
online: →	kv-m12	kmpv	kvi	vmpa-kms

Product overview



Connecting cables >

Connecting cables for sensors

	 Connecting cables NEBB	 Connecting cables NEBS ★	 Connecting cables NEBU ★
Electrical connection, connection type	Socket, Cable	Socket, Cable, Plugs	Socket, Cable, Plugs
Electrical connection, cable outlet	Straight, Angled	Straight	Straight, Angled, Angled, can be aligned in increments of 15°
Electrical connection, design	Round	Angular, Round	Round
Electrical connection, connection technology	M12x1, A-coded to EN 61076-2-101, Open end, M8x1, A-coded, to EN 61076-2-104	Connection pattern L1J, M12x1, A-coded to EN 61076-2-101, M16x0.75, Open end	G7/8 coded to NFPA/T3.5.29 R1-2007, M12x1, A-coded to EN 61076-2-101, M8x1, A-coded to EN 61076-2-104, Open end, M8x1, A-coded, to EN 61076-2-104
Electrical connection, number of pins/wires	3, 4, 5	4, 5, 12, 24, 25	3, 4, 5, 8
Cable length	2.5 ... 10 m	0.3 ... 15 m	0.1 ... 30 m
Description	<ul style="list-style-type: none"> • For thread M8x1 A-coded according to EN 61076-2-104 • For thread M12x1 A-coded according to EN 61076-2-101 • Pre-assembled at one end • With PVC cable • Ambient temperature -25 ... +70 °C 	<ul style="list-style-type: none"> • For connection with rectangular design L1, grid dimension 5.8 mm • For thread M12x1 A-coded according to EN 61076-2-101 • For thread M16x0.75 • Connecting cable for pressure sensor SPAN • Degree of protection IP40, IP65, IP67, IP69K, when mounted • With PVC or PUR cable • Ambient temperature -40 ... +70 °C 	<ul style="list-style-type: none"> • For thread M8x1 A-coded according to EN 61076-2-104 • For thread M12x1 A-coded according to EN 61076-2-101 • Pre-assembled at one or both ends • Designs for static, standard, energy chain and robot applications • Cable length 0.1 ... 30 m • With PVC or PUR cable • Ambient temperature -25 ... +80 °C
online: →	nebb	nebs	nebu

Connecting cables >





Connecting cables for sensors

		
	Connecting cables/plug sockets with cable SIM	Connecting cables KM12
Electrical connection, connection type	Socket, Cable	Socket, Plugs
Electrical connection, cable outlet	Straight, Angled	Straight
Electrical connection, design	Round	Round
Electrical connection, connection technology	M12x1, A-coded to EN 61076-2-101, Open end, M8 snap-locking A-coded to EN 61076-2-104	M12x1, A-coded to EN 61076-2-101
Electrical connection, number of pins/wires	3, 4, 8	8
Cable length	2 ... 25 m	2 m
Description	<ul style="list-style-type: none"> • For thread M8 grid locking A-coded according to EN 61076-2-104 • For thread M12x1 A-coded according to EN 61076-2-101 • Pre-assembled at one end • With PVC or PUR cable • Ambient temperature -25 ... +80 °C 	<ul style="list-style-type: none"> • For thread M12x1 A-coded according to EN 61076-2-101 • Pre-assembled at both ends • With PUR cable • Ambient temperature -25 ... +80 °C
online: →	sim	km12

Product overview



Plugs >

Universal plug connectors

	 T-distributors NEDY	 Cable sockets NEFU	 Plugs, power supply sockets NECU, NECU-HX	 Push-in T-connectors NEDU
Electrical connection			3-pin, 4-pin, 7-pin, 8-pin, A-coded, Spring-loaded terminal, Screw terminal, Straight plug/insulation displacement connector, Straight plug, Square design, M8x1, M12x1	4-pin/4-pin/4-pin, A-coded/A-coded/A-coded, Socket/socket/plug connector, M12x1/M12x1/M12x1
Electrical connection, connection type	2x socket, 2x cable, Cable, Plugs		2x cable, Socket, Cable, Plugs	
Electrical connection, design	Angular, Round		Angular, Round	
Electrical connection, connection technology	Connection pattern ZB, self-tapping screw, Connection pattern ZC, self-tapping screw, Plug pattern ZC, metric screw, Connection pattern H, Plug pattern type A to EN 175301-803, Plug pattern type B to EN 175301-803, Plug pattern type B to industry standard, 11 mm, Plug pattern type C to EN 175301-803, Plug pattern type C to industry standard, 9.4 mm, M12x1, A-coded to EN 61076-2-101, M8x1, A-coded to EN 61076-2-104, M8x1, A-coded, to EN 61076-2-104, Open end		Connection pattern FC, Spring-loaded terminal, Connection pattern PP, coding on pins 2 and 5, M12x1, A-coded to EN 61076-2-101, Insulation displacement connector, Screw terminal, M8x1, A-coded, to EN 61076-2-104	
Electrical connection, number of pins/wires	2, 3, 4, 5		4, 5, 40	
Degree of protection	IP65, IP67, IP68, IP69K	IP20, IP65, IP67, In assembled state, To IEC 60529	IP20, IP40, IP65, IP67	IP65, IP67
Connection cross section			0.08 ... 2.5 mm ²	
Description	<ul style="list-style-type: none"> Collecting signals between field devices (sensors) and double-assigned controller inputs Distributing signals between double-assigned controller outputs and field devices (actuators, e.g. valves) 	<ul style="list-style-type: none"> Cable socket for branching the AS-Interface network at any required point Reconnecting AS-Interface flat cable to 5-pin M12 socket Reverse polarity protected 	<ul style="list-style-type: none"> Power supply socket for fieldbus connection NECU-HX: reconnectable M8 and M12 round plug connector with Harax® quick connection technology for low-voltage applications Plug and socket for power supply Can be assembled with any cable lengths 	<ul style="list-style-type: none"> For fieldbus interface Branch line for connecting and disconnecting fieldbus components
online: →	nedu	nefu	necu	nedu



Plugs >

Universal plug connectors

	 Multi-pin plug distributors NEDU	 Multi-pin plug distributors MPV-E/A	 Plug connectors SEA
Electrical connection			3-pin, 4-pin, 5-pin, Type A, Straight plug/ soldered connection, Straight plug connector/screw terminal, M8x1, M12x1, M12x1 Round plug connector
Electrical connection, connection type			Plugs
Electrical connection, design			Round
Electrical connection, connection technology			M12x1, A-coded to EN 61076-2-101, Screw terminal, M8x1, A-coded, to EN 61076-2- 104
Electrical connection, number of pins/wires			3, 4, 8
Degree of protection	IP68	IP65, In assembled state, To IEC 60529	IP65, IP67
Connection cross section			0.14 ... 0.75 mm ²
Description	<ul style="list-style-type: none"> Particularly compact LED switching status indication 	<ul style="list-style-type: none"> Mounting: H-rail mounting or via through-holes LED switching status indication 	<ul style="list-style-type: none"> Sensor plug for inputs/outputs Can be assembled with any cable lengths
online: →	nedu	mpv	sea

Plugs >



Universal plug connectors

	 Cable distributors ASI-KVT	 Cable sockets ASI-SD
Electrical connection		2-pin, 4-pin, Straight socket, Screw terminal
Electrical connection, connection type		
Electrical connection, design		
Electrical connection, connection technology		
Electrical connection, number of pins/wires		
Degree of protection	IP65	IP65, IP67
Connection cross section	1.5 mm ²	0.75 ... 1.5 mm ²
Description	<ul style="list-style-type: none"> Flat cable distributor for branching or for reconnecting AS-Interface flat cables Reverse polarity protected 	<ul style="list-style-type: none"> For AS-Interface Flat-cable socket for connecting AS-Interface stations to the AS-Interface bus system M12 connection Reverse polarity protected Detachable connection
online: →	asi-kvt	asi-sd

Product overview

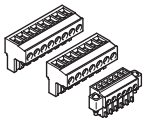
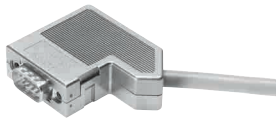

Plugs >

Plug connectors for control systems

	 Assortments of plugs NEKM ★	 Plug connectors NECC	 Plug connectors PS1-SAC, PS1-ZC	 Plug connectors FBS-SUB-9-WS
Electrical connection		9-pin/9-pin, Sub-D/screw terminal	10-pin/30-pin, Socket/terminal strip	
Electrical connection, connection type		Socket		
Electrical connection, design		Angular		
Electrical connection, connection technology		Spring-loaded terminal, Connection pattern L8		
Electrical connection, number of pins/wires		5		
Degree of protection		IP20, IP40		IP40
Connection cross section			0.08 ... 0.75 mm ²	
Description	<ul style="list-style-type: none"> • For motor controllers CMMS-ST, CMMP-AS • For servo drive CMMT-AS 	<ul style="list-style-type: none"> • Encoder plug for motor controller CMMS-ST • For controllers CECC • 2-pin, 4-pin, 6-pin, 8-pin, 11-pin, 18-pin 	<ul style="list-style-type: none"> • For power supply • Cable connection using clamping technology • Individually or as a set 	<ul style="list-style-type: none"> • Plug connector for CAN bus and PROFIBUS bus connection • Cable connection 2x horizontal or 2x vertical • PCB terminal block with screw connector
online: →	nekm	necc	ps1	fbs-sub-9-ws

Plugs >

Plug connectors for control systems

	 Plug connectors FBS-RJ45	 Plug socket NEFF	 Plug, adapter, manifold block NEFC
Electrical connection			5-pin, Plugs, M12x1
Electrical connection, connection type			Socket, Plugs
Electrical connection, design			Round
Electrical connection, connection technology			M12x1, A-coded to EN 61076-2-101
Electrical connection, number of pins/wires			5, 8
Degree of protection	IP65, IP67, To IEC 60529	IP40	IP20, IP65, IP67
Connection cross section			
Description	<ul style="list-style-type: none"> • Ethernet plug with 8-pin RJ45 connection • High transmission quality • Detachable connection 	<ul style="list-style-type: none"> • For operation of an interlock-capable valve terminal interface in pure I-Port mode 	<ul style="list-style-type: none"> • Adapter, 5-pin M12, for mini USB socket with controller software for CPX terminal • Adapter for rotary drive unit ERMS which forms a connection between the motor and IO-Link master • Plug and manifold block for motor controller CMMO-ST to form a connection from the I/O interface to the controller
online: →	fbs-rj	neff	nefc

Plugs >

Plugs for motors







Adapter
NEFM

Electrical connection 1, connection type	Socket, Plugs
Electrical connection, design	Angular
Electrical connection, connection technology	Connection pattern RE, RJ45, Sub-D
Electrical connection, number of pins/wires	6, 8, 9
Degree of protection	IP20
Description	<ul style="list-style-type: none"> • Pre-assembled • For the encoder connection of the servo motor EMMB to the servo drive CMMT-AS • With PVC cable • Ambient temperature -40 ... +80 °C
online: →	nefm

Product overview





Plugs >

Plug connectors for valves

	 Plug sockets MSSD	 Electrical plug-in base, adapter NEFV	 Soldering bases PCBC	 Multi-pin plug sockets NECA
Electrical connection	3-pin, 4-pin, Socket, Angled socket, Type A, Type B, Type C, To DIN EN 175301-803, To DIN EN 61984, Square design, Square design MSC, Square design MSEB, Square design MSF, Square design MSN1, Square design MSN2, Square design MSV		2-pin	
Electrical connection, connection type	Socket	Socket, 4x plug connectors		
Electrical connection, design	Angular	Angular, Round		
Electrical connection, connection technology	Plug pattern type A to EN 175301-803, Plug pattern type B to industry standard, 11 mm, Screw terminal	M12x1, A-coded to EN 61076-2-101, ZIF		
Electrical connection, number of pins/wires	3	5, 8, 12		
Connection cross section	0.25 ... 1.5 mm ²			0.34 ... 1 mm ²
Degree of protection	IP50, IP65, IP67, To IEC 60529	IP40, IP65, IP67	IP40	IP65, To IEC 60529
Description	<ul style="list-style-type: none"> For valves with F, D, N1, V, E, EB, N2, Y, Z, ZB, ZC, MD-2 and MH-2 solenoid coils For connecting individual valves Available with LED display 	<ul style="list-style-type: none"> Adapter for connecting the piezo valves to the electronics module VAVE-P12 	<ul style="list-style-type: none"> For mounting miniature valves MHA1 and MHP1 on a PCB with plug connection underneath (-PI) 	<ul style="list-style-type: none"> For soft-start/quick exhaust valves MS6-SV, MS series Electrical connection via 9-pin Sub-D, 9-pin screw terminal
online: →	mssd	nefv	pcbc	neca

Plugs >

Plug connectors for valves

	 Angled plug sockets MPPE-3-B	 Time delay inserts MFZ	 Illuminating seals MC-LD, ME-LD, MEB-LD, MF-LD, MV-LD	 Indicating inserts MCL, MCLZ, MFL, MFLZ
Electrical connection	8-pin, Angled socket, Solderable		Type A, Type B, Type C, To DIN EN 175301-803, Square design MSC, Square design MSE, Square design MSEB, Square design MSF, Square design MSV	Plugs, To DIN 43650
Electrical connection, connection type				
Electrical connection, design				
Electrical connection, connection technology				
Electrical connection, number of pins/wires				
Connection cross section	0.75 mm ²			
Degree of protection	IP67	IP64	IP65	IP65
Description	<ul style="list-style-type: none"> • For proportional pressure regulators MPPE and MPPES • Mounting via union nut 	<ul style="list-style-type: none"> • Electronic timer with adjustable delay time of between 0 ... 10 s • For mounting between the solenoid coil and connector socket or device plug 	<ul style="list-style-type: none"> • The seal lights up yellow when the power is switched on • For mounting between the solenoid coil and connector socket or device plug • For F, D, N1, V, E and EB solenoid coils 	<ul style="list-style-type: none"> • Variant with integrated protective circuit • For mounting between the solenoid coil and connector socket or device plug • With yellow LED display
online: →	mppe-3-b	mfz	mc-ld	mcl

Product overview



Plugs >

Plug connectors for valve terminals

	 Plug sockets FBSD-GD, FBSD-WD	 Plug sockets NTSD-GD, NTSD-WD	 Bus connections FBA-1, FBA-2	 Plug connectors FBS-SUB, FBS-SCRJ, FBS-M12
Electrical connection	4-pin, 5-pin, 5-pin/5-pin, Straight socket/screw terminal, Angled socket/screw terminal, Type A, M12x1	4-pin, 5-pin, Straight socket, Angled socket, Screw terminal, Straight plug connector/screw terminal	9-pin/5-pin, Straight socket/straight plug connector, Straight socket/plug connector and socket, Sub-D/-, Sub-D/M12x1	5-pin, Type A, Straight plug connector/screw terminal, M12x1
Fieldbus interface			Socket and plug, M12x1, 5-pin, B-coded	1x 5 spring-loaded terminals, 1x 9 spring-loaded terminals, 2x 2 spring-loaded terminals, 2x 4 spring-loaded terminals, 2x 5 spring-loaded terminals
Degree of protection	IP20, IP67	IP67	IP40, IP65, To IEC 60529	IP65, IP67, In assembled state, To IEC 60529
Connection cross section	0.2 ... 2.5 mm ²	0.75 ... 2.5 mm ²		0.75 mm ²
Description	<ul style="list-style-type: none"> For fieldbus interface Straight or angled design Can be assembled with any cable lengths 	<ul style="list-style-type: none"> Straight or angled design For power supply Can be assembled with any cable lengths 	<ul style="list-style-type: none"> Can be assembled with any cable lengths 	<ul style="list-style-type: none"> Variants for different fieldbus systems Position of DIL switches can be read externally Easy assembly
online: →	fbs	ntsd	fba	fbs-sub



Plugs >

Plug connectors for valve terminals

	 Sensor sockets, angled plug sockets SIE-GD, SIE-WD	 Cover caps ISK	 Plug sockets, plug connectors SD-SUB
Electrical connection	4-pin, Straight socket/screw terminal, Angled socket/screw terminal, M12x1		25-pin, Plugs, Sub-D
Fieldbus interface			
Degree of protection	IP67	IP65	IP65
Connection cross section	0.25 ... 0.75 mm ²		
Description	<ul style="list-style-type: none"> For customised fabrication of cables Pin adapter for fieldbus interface With screw terminals Straight or angled design 	<ul style="list-style-type: none"> For sealing unused ports/openings Thread M8, M12 	<ul style="list-style-type: none"> Plug socket for multi-pin plug connection Plug for inputs/outputs Can be assembled with any cable lengths
online: →	sie-gd	isk	sd-sub



Plugs >

Plug connectors for valve terminals

	 Bus connections FBSD-KL	 T adapter FB-TA
Electrical connection	5-pin/5-pin, Angled socket/screw terminal	5-pin, M12x1/M12x1, Plug connectors/sockets
Fieldbus interface		
Degree of protection	IP20	IP67
Connection cross section	0.2 ... 2.5 mm ²	
Description	<ul style="list-style-type: none"> • 5-pin angled socket, 5-pin screw terminal 	<ul style="list-style-type: none"> • Branch line for connecting and disconnecting fieldbus components • For fieldbus connection with thread M12x1 A-coded according to EN 61076-2-101 • Cable length 150 mm
online: →	fbbsd-kl	fb-ta

Plugs >

Plug connectors for sensors

	 Angled plug sockets PEV-...WD	 Plug sockets SD-4-WD
Electrical connection	4-pin, Angled socket	
Degree of protection	IP65	IP65, To IEC 60529
Description	<ul style="list-style-type: none"> • For pressure switch PEV • 15 ... 30, 180 V DC, 230 V AC • Available with LED display • Angled design 	<ul style="list-style-type: none"> • For swivel module DSMI • Angled design
online: →	pev*wd	sd-4-wd

Product overview

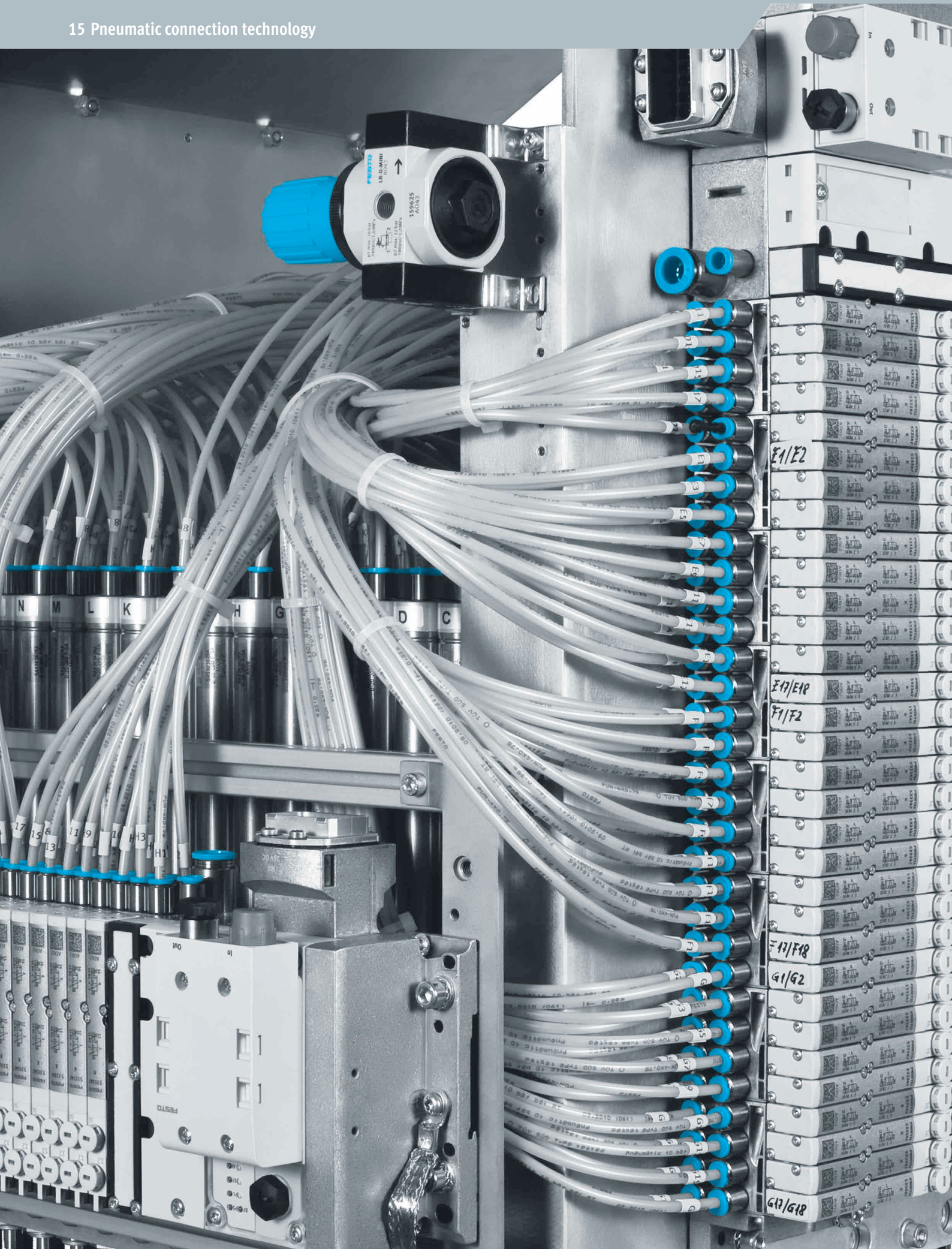



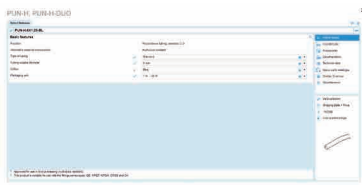
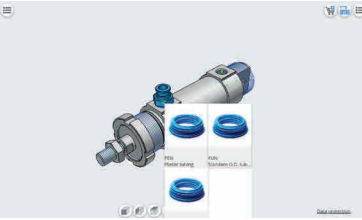

Product overview

Software tools

Configurator for tubing		<p>Design a product with numerous features reliably and quickly with the help of the configurator.</p> <p>Select all the required product features step-by-step.</p> <p>The use of logic checks ensures that only correct configurations are available for selection.</p> <p>You will find the configurator for your desired product</p> <ul style="list-style-type: none"> • at www.festo.com/catalogue/tubing • Select your desired product • Click on the blue “Configure product” button
Festo Design Tool 3D		<p>The Festo Design Tool 3D is a 3D product configurator for generating specific CAD product combinations from Festo.</p> <p>The configurator makes your search for the right accessory easier, more reliable and faster.</p> <p>You can then order the module that has been created as a single order item, either completely pre-assembled or as individual parts in a single box.</p> <p>This considerably reduces your bill of materials, and downstream processes such as product ordering, order picking and assembly are significantly simplified.</p> <p>This tool can be found at www.festo.com/x/festo-design-tool</p>





Tubing >

Standard O.D. tubing

				
	Plastic tubing PUN-H, PUN-H-DUO	Plastic tubing PUN-H-F	Plastic tubing PUN, PUN-DUO	Plastic tubing PTFEN
Outside diameter	2 ... 16 mm	4 ... 16 mm	3 ... 16 mm	4 ... 16 mm
Inside diameter	1.2 ... 11 mm	2.6 ... 11 mm	2.1 ... 11 mm	2.9 ... 11 mm
Temperature-dependent operating pressure [MPa]	-0.095 ... 1 MPa	-0.095 ... 1 MPa	-0.095 ... 1 MPa	
Temperature-dependent operating pressure	-0.95 ... 10 bar	-0.95 ... 10 bar	-0.95 ... 10 bar	-0.95 ... 15 bar
Temperature-dependent operating pressure [psi]	-13.775 ... 145 psi	-13.775 ... 145 psi	-13.775 ... 145 psi	
Ambient temperature	-35 ... 60°C	-35 ... 60°C	-35 ... 60°C	-20 ... 150°C
NEW		• New product, 04/2022		
Description	<ul style="list-style-type: none"> • Polyurethane • High resistance to microbes and hydrolysis • Food grade see www.festo.com/certificates/PUN_H • Suitable for use with energy chains • Clean room-compatible combination with fitting NPKA • Also available as DUO plastic tubing • Operating medium: compressed air, vacuum, water 	<ul style="list-style-type: none"> • Polyurethane • High resistance to microbes and hydrolysis • For food safety certificates, see www.festo.com/certificates/PUN_H_F • Clean room-compatible combination with fitting NPKA • Operating medium: compressed air, vacuum, water 	<ul style="list-style-type: none"> • Polyurethane • High resistance to stress cracks • Suitable for use with energy chains • Also available as DUO plastic tubing • Operating medium: compressed air, vacuum 	<ul style="list-style-type: none"> • Polytetrafluoroethylene • Food grade see www.festo.com/certificates/PTFEN • High resistance to chemicals • High temperature resistance • Operating medium: compressed air, vacuum
online: →	pun-h	pun-h-f	pun	ptfen



Tubing >

Standard O.D. tubing

				
	Plastic tubing PUN-CM	Plastic tubing PUN-V0	Plastic tubing PEN	Plastic tubing PAN
Outside diameter	4 ... 12 mm	4 ... 16 mm	4 ... 16 mm	4 ... 16 mm
Inside diameter	2.5 ... 8 mm	2 ... 11.8 mm	2.7 ... 10.8 mm	2.9 ... 12 mm
Temperature-dependent operating pressure [MPa]	-0.095 ... 1 MPa	-0.095 ... 3 MPa	-0.095 ... 1 MPa	-0.095 ... 1.9 MPa
Temperature-dependent operating pressure	-0.95 ... 10 bar	-0.95 ... 30 bar	-0.95 ... 10 bar	-0.95 ... 19 bar
Temperature-dependent operating pressure [psi]	-13.775 ... 145 psi	-13.775 ... 435 psi	-13.775 ... 145 psi	-13.775 ... 275.5 psi
Ambient temperature	-35 ... 60°C	-35 ... 60°C	-30 ... 60°C	-30 ... 80°C
Description	<ul style="list-style-type: none"> • Polyurethane • Plastic tubing, antistatic, electrically conductive • Suitable for use with energy chains • Operating medium: compressed air, vacuum 	<ul style="list-style-type: none"> • Polyurethane • Flame retardant to UL 94 V0 ... V2 • For use in the immediate vicinity of welding applications • High resistance to microbes and hydrolysis • Suitable for use with energy chains • Operating medium: compressed air, vacuum, water 	<ul style="list-style-type: none"> • Polyethylene • High resistance to chemicals and very high resistance to hydrolysis • Resistant to most cleaning agents and lubricants • Suitable for use with energy chains • Operating medium: compressed air, vacuum, water 	<ul style="list-style-type: none"> • Polyamide • High thermal and mechanical load capacities • Highly resistant to microbes • Operating medium: compressed air, vacuum
online: →	pun-cm	pun-v0	pen	pan

Tubing >



Standard O.D. tubing

			
	Customised tubing PAN, PEN, PLN, PUN	Plastic tubing PAN-MF	Heavy-duty tubing PAN-R
Outside diameter	3 ... 16 mm	4 ... 16 mm	4 ... 28 mm
Inside diameter	2 ... 12 mm	2.5 ... 12 mm	2.5 ... 23 mm
Temperature-dependent operating pressure [MPa]		-0.095 ... 3.1 MPa	-0.095 ... 3.5 MPa
Temperature-dependent operating pressure	-0.95 ... 35 bar	-0.95 ... 31 bar	-0.95 ... 35 bar
Temperature-dependent operating pressure [psi]		-13.775 ... 449.5 psi	-13.775 ... 507.5 psi
Ambient temperature	-60 ... 100°C	-60 ... 100°C	-30 ... 80°C
Description	<ul style="list-style-type: none"> • Individual lengths: delivered in units of 25, 50, 100, 200 ... 500 m • Minimum quantity: 3000 m • Individual design: labelled with your company name and/or your part number • Easy to recognise and handle: individual colour selection • Choose from 9 basic colours; further colours available on request • Select, size and order quickly, easily and reliably with the configurator 	<ul style="list-style-type: none"> • Polyamide • High thermal and mechanical load capacities • Meets the requirements to DIN 73378 "Polyamide tubing for use in motor vehicles" • Operating media: compressed air, mineral oil 	<ul style="list-style-type: none"> • Polyamide • For applications with high pressure ranges • Highly resistant to microbes • Operating medium: compressed air, vacuum
online: →	pan	pan-mf	pan-r

Product overview

Tubing >

Standard O.D. tubing

	 Plastic tubing PAN-V0	 Plastic tubing PLN	 Plastic tubing PFAN
Outside diameter	6 ... 14 mm	4 ... 16 mm	3 ... 12 mm
Inside diameter	2.5 ... 9 mm	2.9 ... 12 mm	2.3 ... 8.4 mm
Temperature-dependent operating pressure [MPa]	-0.095 ... 1.2 MPa	-0.095 ... 1.4 MPa	
Temperature-dependent operating pressure	-0.95 ... 12 bar	-0.95 ... 14 bar	-0.95 ... 16 bar
Temperature-dependent operating pressure [psi]	-13.775 ... 174 psi	-13.775 ... 203 psi	
Ambient temperature	-30 ... 90°C	-30 ... 80°C	-20 ... 150°C
Description	<ul style="list-style-type: none"> • Polyvinyl chloride, polyamide • Flame retardant according to UL 94 V0 • High resistance to microbes and UV radiation • Double-sheath tubing • Operating medium: compressed air, vacuum, water, mineral oil • Resistant to welding spatter 	<ul style="list-style-type: none"> • Polyethylene • High resistance to chemicals, microbes and hydrolysis • Food grade see www.festo.com/certificates/PLN • Resistant to most cleaning agents and lubricants • Operating medium: compressed air, vacuum, water 	<ul style="list-style-type: none"> • Perfluoroalkoxy alkane • Pneumatic tubing with resistance to high temperatures and chemicals • Food grade see www.festo.com/certificates/PFAN • High resistance to chemicals, microbes, UV radiation, hydrolysis and stress cracks • Operating medium: compressed air, vacuum, water
online: →	pan-v0	pln	pfan



Tubing >

Standard I.D. tubing

	 Plastic tubing PU
Outside diameter	11.6 ... 17.6 mm
Inside diameter	9 ... 13 mm
Operating pressure for entire temperature range	-0.95 ... 10 bar
Ambient temperature	-35 ... 60°C
Description	<ul style="list-style-type: none"> • Polyurethane with fabric • High resistance to abrasion and kinks • Operating media: compressed air, vacuum (PU-13)
online: →	pu

Tubing >



Spiral tubing

	 Spiral plastic tubing PUN-S, PUN-S-DUO	 Spiral plastic tubing PUN-SG	 Spiral plastic tubing PPS
Outside diameter	4 ... 12 mm	9.5 ... 11.7 mm	6.3 ... 7.8 mm
Inside diameter	2.6 ... 8 mm	6.4 ... 7.9 mm	4.7 ... 6.2 mm
Working length	0.5 ... 6 m	2.4 ... 6 m	7.5 ... 15 m
Temperature-dependent operating pressure	-0.95 ... 10 bar	-0.95 ... 15 bar	-0.95 ... 21.2 bar
Ambient temperature	-35 ... 60°C	-40 ... 60°C	-30 ... 80°C
Description	<ul style="list-style-type: none"> • Polyurethane • Also available as DUO plastic tubing • Operating medium: compressed air, vacuum • High resistance to UV radiation and stress cracks 	<ul style="list-style-type: none"> • Polyurethane, nickel-plated brass, polyacetal • Pre-assembled with captive rotatable fittings • High resistance to microbes and hydrolysis • Operating medium: compressed air, vacuum 	<ul style="list-style-type: none"> • Polyamide, brass, galvanised steel • Pre-assembled with 2 rotatable connectors and captive sealing rings OL • Highly resistant to microbes • Operating medium: compressed air, vacuum
online: →	pun-s	pun-sg	pps

Product overview



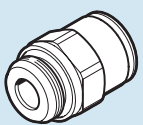

Fittings >

Push-in fittings

				 NEW
	Push-in fittings/connectors, mini series QSM, QSMC, QSMF, QSML, QSMP, QSMS, QSMT, QSMX, QSMY ★	Push-in fittings/connectors, standard series QS, QSC, QSF, QSH, QSL, QSS, QST, QSW, QSX, QSY ★	Push-in fittings/connectors NPQH	Push-in fittings/connectors NPQE-F1A
Pneumatic connection 1	Male thread M8x1.25, Female thread M3, M5, For tubing O.D. 2 mm, 3 mm, 4 mm, 6 mm, Male thread G1/8, M3, M5, M6, M6x0.75, M7, M8x0.75, R1/8, Push-in sleeve QS-2, QS-3, QS-4, QS-6	Female thread G1/2, G1/4, G1/8, G3/8, For tubing O.D. 10 mm, 12 mm, 16 mm, 4 mm, 6 mm, 8 mm, Male thread G1/2, G1/4, G1/8, G3/4, G3/8, M5, R1/2, R1/4, R1/8, R3/8, Push-in sleeve QS-10, QS-12, QS-16, QS-4, QS-6, QS-8	Female thread G1/4, G1/8, For tubing O.D. 10 mm, 12 mm, 14 mm, 4 mm, 6 mm, 8 mm, Male thread G1/2, G1/4, G1/8, G3/8, M5, M7, Push-in sleeve QS-10, QS-12, QS-14, QS-4, QS-6, QS-8	For tubing O.D. 10 mm, 12 mm, 4 mm, 6 mm, 8 mm, Male thread G1/4, G1/8, M3, M5, M7, R1/4, R1/8
Pneumatic connection 2	For tubing O.D. 2 mm, 3 mm, 4 mm, 6 mm	Female thread G1/2, G1/4, G1/8, G3/8, For tubing O.D. 10 mm, 12 mm, 16 mm, 22 mm, 4 mm, 6 mm, 8 mm, Push-in sleeve QS-10, QS-12, QS-16, QS-4, QS-6, QS-8	For tubing O.D. 10 mm, 12 mm, 14 mm, 4 mm, 6 mm, 8 mm, Push-in sleeve QS-10, QS-12, QS-14, QS-4, QS-6, QS-8	For tubing O.D. 10 mm, 12 mm, 4 mm, 6 mm, 8 mm
Temperature-dependent operating pressure	-0.95 ... 14 bar	-0.95 ... 14 bar		
Operating pressure for entire temperature range	-0.95 ... 6 bar	-0.95 ... 14 bar	-0.95 ... 20 bar	-0.95 ... 8 bar
Ambient temperature	-10 ... 80°C	-20 ... 80°C	0 ... 150°C	-5 ... 60°C
NEW				<ul style="list-style-type: none"> • New product, 11/2021
Description	<ul style="list-style-type: none"> • Mini series • Compact for maximum component density in confined installation spaces • PBT and nickel-plated brass • Operating medium: compressed air, vacuum 	<ul style="list-style-type: none"> • Standard series • Wide range of variants: wide selection for maximum flexibility in standard applications • PBT and nickel-plated brass • Operating media: compressed air, vacuum, (water) 	<ul style="list-style-type: none"> • Solid-metal brass, chemically nickel-plated • High corrosion and chemical resistance • Highly resistant to temperatures and pressure • Food grade see www.festo.com/certificates/NPQH • Operating medium: compressed air, vacuum, water 	<ul style="list-style-type: none"> • Economical push-in fittings for pneumatic applications • Recommended for production facilities for manufacturing of lithium-ion batteries • Tapered thread in accordance with JIS B0203 and compatible with pressure-tight media to DIN EN 10226 • Operating medium: compressed air, vacuum
online: →	qsm	qs	npqh	npqe

Fittings >





Push-in fittings

	 NEW Push-in fittings/connectors NPQR	 Push-in fittings/connectors, metal, standard series NPQM	 Push-in fittings/connectors, resistant to media NPQP	 Cartridges, polymer, black QSPK, QSPLK
Pneumatic connection 1	For tubing O.D. 10 mm, 12 mm, 14 mm, 16 mm, 4 mm, 6 mm, 8 mm, Male thread G1/2, G1/4, G1/8, G3/8, M5, M7	For tubing O.D. 10 mm, 12 mm, 14 mm, 4 mm, 6 mm, 8 mm, Push-in sleeve QS-10, QS-12, QS-14, QS-4, QS-6, QS-8, G1/2, G1/4, G1/8, G3/8, M5, M7	For tubing O.D. 10 mm, 12 mm, 4 mm, 6 mm, 8 mm, Push-in sleeve QS-10, QS-12, QS-4, QS-6, QS-8, R1/2, R1/4, R1/8, R3/8	Cartridge 10 mm, 18 mm
Pneumatic connection 2	For tubing O.D. 10 mm, 12 mm, 14 mm, 16 mm, 4 mm, 6 mm, 8 mm	For tubing O.D. 10 mm, 12 mm, 14 mm, 3 mm, 4 mm, 6 mm, 8 mm	For tubing O.D. 10 mm, 12 mm, 4 mm, 6 mm, 8 mm	For tubing O.D. 10 mm, 3 mm, 4 mm, 6 mm, 8 mm
Temperature-dependent operating pressure			-0.95 ... 10 bar	
Operating pressure for entire temperature range	-0.95 ... 16 bar	-0.95 ... 16 bar		-0.95 ... 10 bar
Ambient temperature	-20 ... 150°C	-20 ... 70°C	-20 ... 60°C	-5 ... 60°C
NEW	<ul style="list-style-type: none"> New for 02/2022: additional versions 			
Description	<ul style="list-style-type: none"> Very easy to clean thanks to chamfered O-ring and fewer edges where dirt can accumulate Optimal price/performance ratio, perfect for applications from a single source Maximum corrosion resistance (corrosion resistance class CRC 4 to Festo standard 940 070) and chemical resistance High temperature resistance Stainless steel Operating media: compressed air, vacuum, (water) 	<ul style="list-style-type: none"> Solid-metal brass, nickel-plated Attractively priced metal push-in fitting Sturdy Operating medium: compressed air, vacuum 	<ul style="list-style-type: none"> Polypropylene Low-cost alternative to stainless steel: resistant to most cleaning agents in combination with tubing PLN For use with extreme media influences Food grade see www.festo.com/certificates/NPQP Operating medium: compressed air, vacuum 	<ul style="list-style-type: none"> Compact installation space Threadless mounting
online: →	npqr	npqm	npqp	qsp

Product overview



Fittings >

Push-in fittings

				
	Cartridges QSPK, QSPLK, NPT	Cartridges, polymer, grey QSPKG, QSPLKG	Cartridges QSPKG, QSPLKG, NPT	Push-in fittings, stainless steel CRQS, CRQSL, CRQSS, CRQST, CRQSY
Pneumatic connection 1	QSP...18	Cartridge 10 mm, 14 mm, 18 mm, 20 mm	QSP...10, QSP...14, QSP...18, QSP...20	For tubing O.D. 10 mm, 12 mm, 16 mm, 4 mm, 6 mm, 8 mm, Male thread M5, R1/2, R1/4, R1/8, R3/8
Pneumatic connection 2	For tubing O.D. 3/8 in "	For tubing O.D. 10 mm, 12 mm, 3 mm, 4 mm, 6 mm, 8 mm	For tubing O.D. 1/2 in ", 1/4 in ", 1/8 in ", 3/8 in ", 5/16 in ", 5/32 in "	For tubing O.D. 10 mm, 12 mm, 16 mm, 4 mm, 6 mm, 8 mm
Temperature-dependent operating pressure				
Operating pressure for entire temperature range	-0.95 ... 10 bar	-0.95 ... 10 bar	-0.95 ... 10 bar	-0.95 ... 10 bar
Ambient temperature	-5 ... 60°C	-5 ... 60°C	-5 ... 60°C	-15 ... 120°C
Description	<ul style="list-style-type: none"> • Compact installation space • Threadless mounting 	<ul style="list-style-type: none"> • Compact installation space • Threadless mounting 	<ul style="list-style-type: none"> • Compact installation space • Threadless mounting 	<ul style="list-style-type: none"> • Maximum corrosion resistance (corrosion resistance class CRC 4 to Festo standard 940 070) and chemical resistance • Food grade see www.festo.com/certificates/CRQS • Operating media: compressed air, vacuum, (water) • Stainless steel
online: →	qsp	qsp	qsp	crqs

Fittings >

Push-in fittings

			
	Push-in fittings, resistant to welding spatter QS-V0, QSL-V0, QST-V0	Self-sealing push-in fittings/connectors QSK, QSKL, QSMK, QSMKL, QSSK	Push-in fittings, rotatable QSR, QSRL
Pneumatic connection 1	For tubing O.D. 10 mm, 12 mm, 4 mm, 6 mm, 8 mm, G1/2, G1/4, G1/8, G3/8, R1/2, R1/4, R1/8, R3/8	For tubing O.D. 10 mm, 12 mm, 4 mm, 6 mm, 8 mm, Male thread G1/2, G1/4, G1/8, G3/8, M5, R1/2, R1/4, R1/8, R3/8	Male thread G1/2, G1/4, G1/8, G3/8, M5, R1/2, R1/4, R1/8, R3/8
Pneumatic connection 2	For tubing O.D. 10 mm, 12 mm, 4 mm, 6 mm, 8 mm	For tubing O.D. 10 mm, 12 mm, 4 mm, 6 mm, 8 mm	For tubing O.D. 10 mm, 12 mm, 4 mm, 6 mm, 8 mm
Temperature-dependent operating pressure		-0.95 ... 14 bar	-0.95 ... 14 bar
Operating pressure for entire temperature range	-0.95 ... 10 bar	-0.95 ... 6 bar	-0.95 ... 6 bar
Ambient temperature	0 ... 60°C	-10 ... 80°C	0 ... 60°C
Description	<ul style="list-style-type: none"> • PBT, reinforced • Resistant to welding spatter • For use in all areas where there is a risk of fire • Reliable even for applications in close proximity to welding spatter • Operating medium: compressed air, vacuum, water 	<ul style="list-style-type: none"> • Standard series • Self-sealing push-in fitting blocks the air flow after the tubing is disconnected • PBT and nickel-plated brass • Operating medium: compressed air, vacuum 	<ul style="list-style-type: none"> • Push-in fitting, rotatable with swivel connection, rotatable by 360° with max. 500 rpm • Compact installation space
online: →	qs-v0	qsk	qsr

Fittings >

Push-in fittings



Push-in fittings
CQA







Cartridges
QSP

Pneumatic connection 1	For pipe and tubing O.D. 22 mm, Push-in sleeve CQ-28	Cartridge 10 mm
Pneumatic connection 2	For pipe and tubing O.D. 22 mm, Push-in sleeve CQ-28	For tubing O.D. 4 mm, 6 mm
Temperature-dependent operating pressure	-0.95 ... 15 bar	
Operating pressure for entire temperature range	-0.95 ... 7 bar	-0.95 ... 10 bar
Ambient temperature	-25 ... 70°C	-10 ... 60°C
Description	<ul style="list-style-type: none"> • Assembling and disassembling without tools • For pipes PQ-PA, PQ-AL and tubing PAN and PUN • Sturdy, air-tight connection 	<ul style="list-style-type: none"> • Plug-in cartridges • Straight or angled design • PBT and nickel-plated brass • Operating medium: compressed air, vacuum
online: →	cq	qsp

Product overview





Fittings >

Barbed fittings

				
	Quick connectors NPCK	Barbed fittings CN, CRCN, FCN, L-PK, LCN, LCNH, N, RTU, SCN, T-PK, TCN, Y-PK	Barbed hose fittings C-P, N-P, N-MS	Quick connectors ACK, CK, CV, FCK, GCK, LCK, MCK, QCK, SCK, TCK
Nominal size	2 ... 6.2 mm	1.3 ... 5.3 mm	4 ... 16.5 mm	2 ... 12 mm
Pneumatic connection 1	Male thread G1/4, G1/8, G3/8, M5	For tubing O.D. 3 mm, 4 mm, 6 mm, 8 mm, Male thread G1/4, G1/8, G3/8, M3, M5	Male thread R1, Male thread 3/4 NPT, Male thread 1 NPT, Female thread G1/2, G1/4, G1/8, G3/8, Male thread G1/2, G1/4, G1/8, G3/4, G3/8	Female thread G1/2, G1/4, G1/8, G3/8, M5, For barbed connector I.D. 3 mm Via union nut, 4 mm Via union nut, 6 mm Via union nut, 9 mm Via union nut, Male thread G1/2, G1/4, G1/8, G3/8, M5, R1/4, R1/8, R3/8
Pneumatic connection 2	For tubing O.D. 10 mm, 4 mm, 6 mm, 8 mm	For tubing O.D. 3 mm, 4 mm, 6 mm, 8 mm	For tubing I.D. 6 mm, For tubing I.D. 19 mm, For tubing I.D. 13 mm, 9 mm, For tubing O.D. 8 mm	For barbed connector I.D. 13 mm Via union nut, 3 mm Via union nut, 4 mm Via union nut, 6 mm Via union nut, 9 mm Via union nut, For tubing I.D. 13 mm, 9 mm, For tubing O.D. 4 mm, 6 mm, 8 mm
Operating pressure for entire temperature range	-0.95 ... 12 bar	-0.95 ... 10 bar	-0.95 ... 16 bar	0 ... 16 bar
Ambient temperature	-20 ... 120°C	-10 ... 60°C	-10 ... 60°C	-10 ... 60°C
Description	<ul style="list-style-type: none"> Stainless steel design Food grade see www.festo.com/certificates/NPCK Fulfils all clean design requirements Straight shape Operating medium: compressed air, vacuum, water 	<ul style="list-style-type: none"> Straight shape, T-shape, L-shape, Y-shape Operating medium: compressed air, vacuum Brass, POM, aluminium or stainless steel 	<ul style="list-style-type: none"> Barbed hose fitting with or without sealing ring Tubing clip to DIN 3017 Operating medium: compressed air, vacuum Brass or aluminium, steel 	<ul style="list-style-type: none"> Bulkhead quick connector Sealing cap for plastic tube fittings and barbed fittings Multiple distributor Union nut for CK tube fitting Operating media: compressed air, vacuum, (water) Aluminium, steel, POM or zinc
online: →	npck	n_070302	n_cnp	ck



Fittings >

Threaded fittings

	 Blanking plugs B	 Threaded fittings NPFC	 Adapters NPFV	 Ring pieces, hollow bolts LK, TK, VT
Pneumatic connection 1	Male thread G1, G1/2, G1/4, G1/8, G3/4, G3/8, M3, M5, M7	G1, G1/2, G1/4, G1/8, G3/4, G3/8, M3, M5, M7, R1, R1/2, R1/4, R1/8, R3/4, R3/8	1/4 NPT, G1/4	Male thread G1/4, G1/8, G3/8, M5
Pneumatic connection 2		G1, G1/2, G1/4, G1/8, G3/4, G3/8, M3, M5, R1, R1/2, R1/4, R1/8, R3/4, R3/8	1/4 NPT, G1/4	For barbed connector I.D. 3 mm Via union nut, 4 mm Via union nut, 6 mm Via union nut
Operating pressure		-0.95 ... 50 bar	2 ... 8 bar	
Operating pressure for entire temperature range				0 ... 10 bar
Description	<ul style="list-style-type: none"> Aluminium, stainless steel With sealing ring Variants recommended for production systems for manufacturing lithium-ion batteries 	<ul style="list-style-type: none"> Brass, nickel-plated Sleeve Extension Double nipple Reducing nipple L-, T-, Y- or X-fitting Operating medium: compressed air, vacuum 	<ul style="list-style-type: none"> Adapter with filter From male thread G1/4 to female thread G1/4 or NPT1/4 and male thread NPT1/4 to female thread NPT1/4 Adapter material: high-alloy stainless steel Operating medium compressed air 	<ul style="list-style-type: none"> Multiple distributor consisting of hollow bolt VT and ring piece LK or TK With two to six outlets and one common air feed Operating medium: compressed air, vacuum Galvanised steel
online: →	b-1	npfc	npfv	lk

Fittings >



Threaded fittings

	 Reducers, sleeve, double nipple FR	 Reducers, sleeve, double nipple G	 Reducers, sleeve, double nipple LJK, TJK
Pneumatic connection 1		M5	
Pneumatic connection 2		M5	
Operating pressure			
Operating pressure for entire temperature range			
Description	<ul style="list-style-type: none"> T-distributor With sealing ring Aluminium 	<ul style="list-style-type: none"> Elbow piece With sealing ring Aluminium 	<ul style="list-style-type: none"> T-fitting, swivelling, with female thread Elbow fitting with female thread With sealing ring
online: →	fr	g	jk

Product overview

Fittings >

Threaded fittings



			
	Reducers, sleeve, double nipple E, ESK	Reducers, sleeve, double nipple QM	Reducers, sleeve, double nipple D
Pneumatic connection 1	R1/2, R1/4, R1/8, R3/8	G1, G1/2, G1/4, G1/8, G3/4, G3/8	M5
Pneumatic connection 2	R1/2, R1/4, R1/8, R3/8	G1, G1/2, G1/4, G1/8, G3/4, G3/8	M7
Operating pressure			
Operating pressure for entire temperature range			
Description	<ul style="list-style-type: none"> For connecting pneumatic components with different threaded connections 	<ul style="list-style-type: none"> For connecting pneumatic components with different threaded connections 	<ul style="list-style-type: none"> Reducing nipple For reducing threaded connections With sealing ring Brass, nickel-plated
online: →	esk	qm	d

Fittings >

Click fitting

	
	Click fittings NPKA
Pneumatic connection 1	Male thread G1/8
Pneumatic connection 2	For tubing O.D. 6 mm
Temperature-dependent operating pressure	-0.95 ... 10 bar
Nominal size	4 mm
Ambient temperature	-10 ... 60°C
Description	<ul style="list-style-type: none"> POM, polyamide 66 Quick and easy one-handed tube installation Completely made of polymer Food grade see www.festo.com/certificates/NPKA Operating medium: compressed air, vacuum, water No copper, fluor or silicone Cleanroom compatible Easy-to-clean design with few corners and edges
online: →	npka

Pipes

			
	Plastic pipes PQ-PA	Pipes PQ-AL	Plastic-coated metal tubes PM
Outside diameter	12 ... 28 mm	12 ... 28 mm	6 ... 8 mm
Information on tubing materials	PA	Wrought aluminium alloy	Wrought aluminium alloy, PE
Temperature-dependent operating pressure	-0.95 ... 15 bar	-0.95 ... 15 bar	-0.95 ... 30 bar
Ambient temperature	-25 ... 75°C	-30 ... 75°C	-29 ... 65°C
Description	<ul style="list-style-type: none"> • Rigid pipe made from high-quality polyamide • Smooth inside wall ensures optimum flow conditions • Operating media: compressed air, vacuum, liquid media 	<ul style="list-style-type: none"> • Rigid aluminium pipe • Smooth inside wall ensures optimum flow conditions • Operating media: compressed air, vacuum, liquid media 	<ul style="list-style-type: none"> • Polyethylene, aluminium • Can be bent straight and reshaped several times without a pipe-bending device and without being damaged • Resistant to deformation • Operating medium: compressed air, vacuum
online: →	pq-pa	pq-al	pm

Push-in fittings for piping PQ



	
	Push-in fittings CQ, CQC, CQH, CQL, CQT
Pneumatic connection 1	For pipe and tubing O.D. 12 mm, 15 mm, 18 mm, 22 mm, 28 mm, Male thread G1, G1/2, G3/4, G3/8, Push-in sleeve CQ-12, CQ-15, CQ-18, CQ-22, CQ-28
Pneumatic connection 2	For pipe and tubing O.D. 12 mm, 15 mm, 18 mm, 22 mm, 28 mm, Push-in sleeve CQ-12, CQ-15, CQ-18, CQ-22, CQ-28, QS-12, QS-16
Nominal size	8 ... 24.9 mm
Temperature-dependent operating pressure	-0.95 ... 15 bar
Ambient temperature	-25 ... 70°C
Description	<ul style="list-style-type: none"> • For pipes PQ-PA, PQ-AL and tubing PAN and PUN • Operating media: compressed air, vacuum, liquid media • POM
online: →	cq

Product overview



Couplings

				
	Quick coupling sockets, quick coupling plugs NPHS-D6, NPHS-S6 ★	Quick coupling sockets, quick coupling plugs KD, KD1, KD2, KD3, KD4, KS, KS1, KS2, KS3, KS4 ★	Multiple connectors KSV, KDV, KDVF	Multi-tube connectors KM
Pneumatic connection			For tubing O.D. 3 mm, 4 mm, 6 mm, 8 mm, PK-2, PK-3, PK-4, PK-6	
Pneumatic connection 1	For plug-in nipple I.D. 9 mm, Female thread G1/2, G1/4, G3/8, Male thread G1/2, G1/4, G1/8, G3/8	N-6, N-9, Female thread G1/2, G1/4, G1/8, G3/8, M5, Male thread G1/2, G1/4, G1/8, G3/8, M3, M5, CK-3, CK-4, CK-6, CK-9, CN-2		
Standard nominal flow rate	875 ... 2083 l/min	44 ... 1350 l/min		
Operating pressure	-0.95 ... 20 bar	-0.95 ... 12 bar	-0.95 ... 16 bar	-0.95 ... 8 bar
Ambient temperature	-20 ... 80°C	-10 ... 60°C	-10 ... 60°C	-10 ... 60°C
Description	<ul style="list-style-type: none"> • Safety coupling • Shut-off at one end • Exhaust the air on the connector side without releasing the coupling • Combination of coupling and hand slide valve • Can be used as an on/off valve • Nickel-plated brass or galvanised hardened steel 	<ul style="list-style-type: none"> • Quick connection coupling for standard applications without safety function • Shut-off at one or both ends • With male or female thread or with barbed fitting or quick connector • Nickel-plated brass, PP • Operating medium: compressed air, vacuum 	<ul style="list-style-type: none"> • POM, aluminium, brass • Multi-plug, multi-socket • Terminal plug and terminal socket • Operating medium: compressed air, vacuum 	<ul style="list-style-type: none"> • Polymer, brass • For max. 22 lines • Used as control cabinet outlets • Operating medium: compressed air, vacuum
online: →	nphs	kd1	ksv	km



Distributors

			
	Push-in fittings QSLV, QSQ, QST3	Push-in fittings QSYTF	Distributors FR
Pneumatic connection 1	For tubing O.D. 10 mm, 6 mm, 8 mm, Male thread G1/2, G1/4, G1/8, G3/8, R1/2, R1/4, R1/8, R3/8	Male thread G1/2, G1/4, G1/8, G3/8, R1/2, R1/4, R1/8, R3/8	Female thread G1/2, G1/4, G1/8, G3/8, G3/4
Pneumatic connection 2	For tubing O.D. 10 mm, 12 mm, 4 mm, 6 mm, 8 mm	Female thread G1/2, G1/4, G1/8, G3/8, For tubing O.D. 10 mm, 12 mm, 6 mm, 8 mm	Female thread G1/2, G1/4, G1/8, G3/8, M3, M5, For tubing O.D. 4 mm, 6 mm
No. of supply lines	1	1	1
No. of outlets	2, 3, 4, 6	3	3, 8, 9, 12
Max. rotational speed			
Description	<ul style="list-style-type: none"> • PBT and nickel-plated brass • L-shape, T-shape • Rotatable 360° • Reducing design • Operating media: compressed air, vacuum, (water) 	<ul style="list-style-type: none"> • PBT and nickel-plated brass • Y-shape • Rotatable 360° • Operating media: compressed air, vacuum, (water) 	<ul style="list-style-type: none"> • Aluminium • 4, 8, 9 or 12 connections • Operating medium: compressed air, vacuum
online: →	qslv	qsytf	fr

Distributors

		
	Distributors CQD	Rotary distributors GF
Pneumatic connection 1	Female thread G1/2	Male thread G1/4, G3/8, G1/2, G1/4, G1/8
Pneumatic connection 2	Female thread G1/2	Female thread G1/4, G3/8, G1/2, G1/4, G1/8, M5
No. of supply lines	1	
No. of outlets	4	
Max. rotational speed		300 ... 3000 rpm
Description	<ul style="list-style-type: none"> • POM • Operating medium: compressed air, vacuum 	<ul style="list-style-type: none"> • 2 or 4 axial and radial outlets • Single or multiple rotary distributor • Operating medium: compressed air, vacuum • Brass, hardened steel
online: →	cq	gf

Protective conduit systems

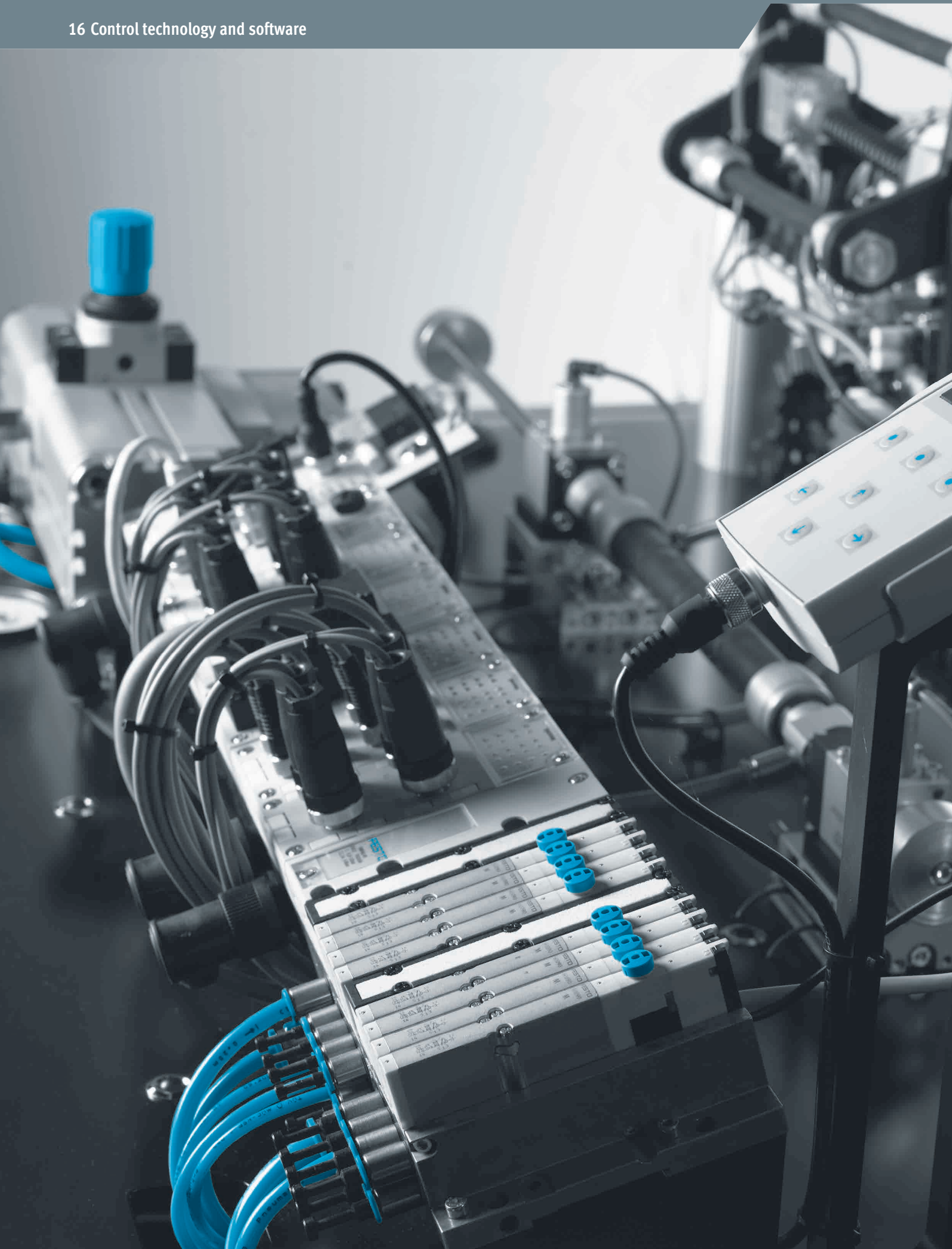

		
	Protective conduits MK, MKG, MKR, MKV	Fittings HMZAS, HMZV, MKA, MKGV, MKM, MKRL, MKRS, MKRT, MKRV, MKVM, MKVV, MKY
Inside diameter	7.5 ... 48 mm	
Outside diameter	10 ... 56 mm	
Threaded connection		Pg9, Pg11, Pg13,5, Pg16, Pg21, Pg29, Pg36, Pg48
Design	Strip-wound metal conduit, internally and externally corrugated all-plastic conduit, separable	
Ambient temperature	-20 ... 100°C	-40 ... 200°C
Description	<ul style="list-style-type: none"> • For protecting pneumatic tubing and electrical cables • Galvanised steel, PA, PP, PVC spring steel • Metal or polymer design • High alternating bending strength 	<ul style="list-style-type: none"> • Installation kit • Junction box • Reducing connector • Protective conduit fitting • Lock nut • Protective conduit connector • Y-distributor • Polymer, polyamide, nickel-plated brass
online: →	mkg	mka

Product overview



Product overview

Pneumatic and electropneumatic controllers

	 Steppers TAA, TAB	 Memory modules SBA-2N	 Pulse generators VLG
Pneumatic connection	Barbed connector for plastic tubing NW3, on mounting frame		
Type of mounting			Through-hole in housing
Nominal size	2 mm	3 mm	3.5 mm, 7 mm
Standard nominal flow rate	60L7min	70 l/min	120 l/min, 600 l/min
Description	<ul style="list-style-type: none"> For ensuring a logical program sequence Poppet valve with integrated AND as well as OR element 	<ul style="list-style-type: none"> For input logic operations For simplifying the design and installation of pneumatic controllers 	<ul style="list-style-type: none"> For generating infinitely adjustable signals in controllers For high-speed cylinder movements of diaphragm cylinders, single- and double-acting cylinders
online: →	taa	sba	vlg

Software tools

CODESYS  <p>CODESYS The IEC 61131-3 Programming System provided by Festo</p>	CODESYS for standardised programming of embedded devices to IEC 61131-3 makes your life easier with simple commissioning, fast programming and parameterisation.
	Benefits <ul style="list-style-type: none"> Hardware-neutral software platform for quick and easy configuration, programming and commissioning of pneumatic and electric automation solutions Extensive module libraries for single- or multi-axis positioning motions. The IEC 61131-3 standard means that CODESYS is flexible and open for all types of control tasks. Modular: offline and online functions as well as components for hardware configuration and visualisation. Convenient IEC function block extension Re-using existing application parts
	This tool can be found <ul style="list-style-type: none"> at www.festo.com Enter “codesys” in the search field on the “Support / Downloads” tab In the list under “Software”

Electronic controllers

	 Controllers CECC-D, CECC-LK, CECC-S
Operating voltage	19.2 - 30 V DC V DC, 20.4 - 30 V DC V DC
CPU data	400 MHz processor
Description	<ul style="list-style-type: none"> Compact programmable logic controller Programming with CoDeSys to IEC 61131-3 12 digital inputs, 8 digital outputs, additionally 2 high-speed counters up to 250 kHz Ethernet 10/100 Mbit/s USB interface for data transfer CECC-LK with CANopen, IO-Link®, I-Port and Modbus TCP protocol
online: →	cecc

Software tools

Festo Automation Suite commissioning software







Quickly and reliably to a ready-to-use drive system – the Festo Automation Suite combines the parameterisation, programming and maintenance of complete drive systems, from the mechanical to the control system, in just one software program. Perfect for making industrial automation simple, efficient and seamless.

Plug-in automation system CPX-E

- Controller programming in CODESYS as a system expansion for SoftMotion – up to robotic applications
- Just 2 mouse clicks instead of 100: greatly simplified integration of the servo drive CMMT-AS into the control program with CPX-E-CEC
- Conveniently install the plug-in using the software

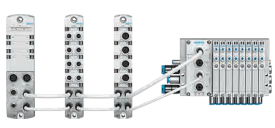

This tool can be found
[➔ on our website at www.festo.com/AutomationSuite](http://www.festo.com/AutomationSuite)

Electrical peripherals



	 Automation systems CPX-AP-I	 Automation systems CPX-E	 CPI installation systems CTEC	 Input modules for installation system CTSL CTSL
Address capacity, inputs		64 Byte		
Max. no. of inputs			128	16
Address capacity, outputs		64 Byte		
Max. no. of outputs			128	
No. of module positions				
Electrical actuation		Fieldbus, Integrated controller	Fieldbus, Integrated controller	
Protocol	PROFIBUS DP, PROFINET, EtherCAT, EtherNet/IP, Modbus®TCP	PROFIBUS DP, PROFINET, EtherCAT, EtherNet/IP, Modbus®TCP, IO-Link®		I-Port, IO-Link®
Description	<ul style="list-style-type: none"> • Powerful remote I/O system that flexibly links 80 modules at a data rate of 200 Mbaud in real-time • Seamless connectivity along with advanced diagnostics option increase the machine availability and productivity • Simple integration into the controller of your choice: PROFINET, PROFIBUS, EtherCAT®, EtherNet/IP, ModbusTCP • Real-time capability and deterministic system behaviour enable cycle times of up to 250 µs • Cable lengths of up to 50 m between every module enable vast system dimensions • The IO-Link master and parameterisation software enable simple integration of any IO-Link® devices • Ethernet performance up to the valve terminal and digital as well as analogue input/output modules 	<ul style="list-style-type: none"> • Modern control system with high performance • Fieldbus master interfaces, EtherCAT® master, fieldbus slave interfaces, PROFINET, EtherNet/IP, PROFIBUS, EtherCAT® digital input modules (16DI), digital output modules (8DO/0.5A) • Analogue input modules (current, voltage), analogue output modules (current, voltage) • Modern programming with CoDeSys V3 to IEC 61131-3 • Integration of SoftMotion functions (SoftMotion) • Compact I/O assembly • Easy mounting of the control system 	<ul style="list-style-type: none"> • CPX master module for four CPI strings • Combination of centralised and decentralised installation possible • Decentralised pneumatic components and sensors for fast processes • Can be connected to valve terminal MPA-S, CPV-SC 	<ul style="list-style-type: none"> • For installation system CTSL • For recording sensor input signals • Display of the input statuses for each input signal via an assigned LED • Diagnostic LED for short circuit/ overload in sensor supply
online: ➔	cpx-api	cpx-e	ctec	ctsl

Product overview

Electrical peripherals

			
	Fieldbus modules CTEU	Terminal CPX-P	Terminal CPX
Address capacity, inputs	2 ... 64 Byte	64 Byte	64 Byte
Max. no. of inputs			
Address capacity, outputs	2 ... 64 Byte	64 Byte	64 Byte
Max. no. of outputs			Max. 9 electric input/output modules
No. of module positions			
Electrical actuation		Fieldbus, Integrated controller	Fieldbus, Integrated controller
Protocol	AS-Interface, CANopen, CC-LINK, CPI-B, DeviceNet, EtherCAT, EtherNet/IP, PROFINET, Modbus® TCP, PROFIBUS DP, VARAN, I-Port	DeviceNet, CANopen, PROFIBUS DP, PROFINET, EtherCAT, EtherNet/IP, Modbus®TCP, IO-Link®, I-Port, HART	Interbus, DeviceNet, CANopen, CC-Link, PROFIBUS DP, PROFINET, EtherCAT, EtherNet/IP, Modbus®TCP, SercosIII, Powerlink, IO-Link®, I-Port, HART
Description	<ul style="list-style-type: none"> For valve terminals VTUG, MPA-L, VTOC Can be expanded into the installation system CTEL Fieldbus-typical LEDs, interfaces and switching elements Isolated power supply for electronics and valves 	<ul style="list-style-type: none"> Use of matching remote I/O and valve terminals in a control cabinet Combination with modules of the electrical terminal CPX, which can then be used for hybrid applications Unique modular structure Comprehensive integrated diagnostic and service functions Analogue inputs and outputs with HART protocol 	<ul style="list-style-type: none"> Automation platform Open to all common fieldbus protocols and Ethernet Integrated diagnostic and maintenance functions Can be used as stand-alone remote I/O or with valve terminals MPA-S, MPA-L, VTSA/VTSA-F Choice of polymer or metal interlinking block with individual linking Analogue inputs and outputs, 2-way/4-way, with optional HART protocol
online: →	cteu	cpx-p	cpx

Electrical peripherals

			
	Measuring modules CPX-CMIX	Electrical interfaces CPX-CTEL	AS-Interface® module ASI
Address capacity, inputs		32 Byte	
Max. no. of inputs			
Address capacity, outputs		32 Byte	
Max. no. of outputs			
No. of module positions		Max. 4 modules with I-Port interface	
Electrical actuation	Via fieldbus		AS-Interface
Protocol		I-Port, IO-Link®	
Description	<ul style="list-style-type: none"> Pneumatics and electrics – movement and measurement on one platform Innovative measurement technology for piston rod drives, rodless drives, rotary drives Control via fieldbus Remote maintenance, remote diagnostics, web server, SMS and e-mail alerts are all possible via TCP/IP Modules can be quickly exchanged and expanded without altering the wiring 	<ul style="list-style-type: none"> CPX-CTEL master module with 4 I-Port connections Decentralised pneumatic components and sensors for fast processes Standardised M12 connections 	<ul style="list-style-type: none"> Accessories for the AS-Interface installation system Compact I/O modules (IP65, IP67)
online: →	cpx-cmix	cpx-ctel	as-interface

Motion controllers







Motor controllers
CPX-CEC-M1



CPU data	800 MHz processor, 256 MB MB RAM, 32 MB MB Flash
Processing time	Approx. 200 µs/1 k instruction
Degree of protection	IP65, IP67
Configuration support	CODESYS V3
Fieldbus interface, type	CAN bus
Fieldbus interface, connection technology	Plugs, Sub-D, 9-pin
Additional functions	Diagnostic functions, SoftMotion functions for electric drives
Description	<ul style="list-style-type: none"> • Easy control of valve terminal configurations • Programming with CoDeSys to IEC 61131-3 • Connection to all fieldbuses as a remote controller and for pre-processing • Control of electric drives via CANopen • SoftMotion functions for coordinated multi-axis movements
online: →	cpx-cec-m1

Product overview



Operator units

	 Operator units CDSA	 IO-Link Master USB CDSU-1	 Operator units CDSB	 Operator units CDPX
Conforms to standard		EN 61131-9		
Electrical connection for IO-Link®, connection type		Socket		
Electrical connection for IO-Link®, connection technology		M12x1, A-coded to EN 61076-2-101		
Electrical connection for IO-Link®, number of pins/wires		5		
Ethernet interface	RJ45			RJ45 10/100 MBd
Protocol		IO-Link®		
Display	LCD display, With backlighting		TFT colour	TFT colour
Display size	7 in “		1.77”	10.4”, 7 in “, 4.3 in “
Recipe memory				32000 Byte
Display resolution	WSVGA, 600x1024 pixels		128x160 pixels	SVGA, 800x600 pixels, WVGA, 800x480 pixels, 480x272 Pixels
Description	<ul style="list-style-type: none"> For mobile commissioning and optimisation Integrated reporting system and user administration in combination with the robotics library from Festo Terminal box for installation in a control cabinet and various cable lengths available Interfaces for Ethernet, RS-422-A/RS-232-C, USB host/USB client With colour touchscreen 	<ul style="list-style-type: none"> Allows Festo IO-Link® products to be commissioned quickly and intuitively Compact, cost-effective, powerful Universal connections Galvanic isolation Connecting cables for almost all IO-Link® devices from Festo For IO-Link® devices with protocol version 1.1 or 1.0 Supports data storage 	<ul style="list-style-type: none"> Plug-in display and control unit for the servo drive CMMT and automation system CPX-E Colour touchscreen Diagnostic function Compact size Mini USB interface Update function for basic unit 	<ul style="list-style-type: none"> Powerful processors combined with wide-screen technology Remote access, remote control FTP and HTTP servers Open for web and multimedia applications With touchscreen
online: →	cdsa	cdsu	cdsb	cdpx

Software

	 Motion Apps GAMM	 Software packages GSAY	 Software (FluidDraw® P6/365) GSWF
Description	<ul style="list-style-type: none"> Open and closed-loop control programs for valves VEVN A new dimension in flexibility thanks to Motion Apps – a single valve with a wide range of different functions Accelerated engineering processes Short response times without the need to adapt the hardware Reduced system complexity Shorter time to market for your application 	<ul style="list-style-type: none"> Modular operating software for the servo press kit YJKP 	<ul style="list-style-type: none"> Quick and easy creation of pneumatic circuit diagrams Comprehensive library of pneumatic and electrical symbols User-specific product databases and translation tables Terminal plans, cable diagrams, cable lists, parts lists Sizing function for preparing simple control cabinet and system layouts Consistent equipment identification Multi-level project tree
online: →	gamm	gsay	gswf

Software

			
	Eplan projects (Schematic Solution) GDDE	Smartenance GASM	Licence GSAR
Description	<ul style="list-style-type: none"> • Create EPLAN documentation for a complex Festo product in just a few minutes • Automated generation to IEC 61355, IEC 81346 and ISO 1219 • Available at any time via the web service 	<ul style="list-style-type: none"> • Digital maintenance and incident management for production managers and system operators • Simple, straightforward operation thanks to clear structure and buttons • Quick and easy to install on mobile devices with Android or iOS operating system • Self-explanatory • Easy and cost-effective introduction to digitalisation • For auditing: detailed proof with one click • Cloud-based: mobile access everywhere • All functions in one application: autonomous maintenance, incident management, system logbook, data interface (REST API) 	<ul style="list-style-type: none"> • Software licence for controlling a handling system from Festo • For point-to-point interpolation or Cartesian interpolation
online: →	gdde	gasm	gsar

Documentation

	
	Descriptions
Description	<ul style="list-style-type: none"> • Manuals, operating instructions
online: →	p.be

Training systems

Learning systems



	
	EduTrainer Universal D:ET-SPS
Description	<ul style="list-style-type: none"> • PLC EduTrainer® support system for use in teaching and training • Equipped with PLCs from different manufacturers • Two series: universal and compact • Equipped with 19 simulation modules • Individually configurable or pre-assembled
online: →	edutrainner

Product overview





Product overview

Control cabinets

	 Factory automation	 Process automation	 Control cabinets for handling systems
Technical data	<ul style="list-style-type: none"> • Simple to complex control cabinet designs • Application-specific combination of components • Fully tested, with test certificate • Ready-to-install • Complete documentation • Design conforms to: <ul style="list-style-type: none"> – EN 60204-1 – ATEX zone 1 and 21 (pneumatic only), ATEX zone 2 and 22 (electric and electropneumatic) – UL-508 A • Implementation of safety functions • Different bus technologies 	<ul style="list-style-type: none"> • Simple to complex control cabinet designs • Application-specific combination of components • Different operating voltages • Fully tested, with test certificate • Ready-to-install • Complete documentation • Design conforms to: <ul style="list-style-type: none"> – EN 60204-1 – ATEX zone 1 and 21 (pneumatic only), ATEX zone 2 and 22 (electric and electropneumatic) – UL-508 A • Implementation of safety functions • Wide range of bus technologies • Compliance with special cleanliness and hygiene requirements • Special materials • Protected against the ingress of liquids and foreign matter • Heating or cooling elements • Intrinsically safe valve terminal technology • Hot swap inspection window 	<ul style="list-style-type: none"> • Simple to complex control cabinet designs • Control of motion sequences with up to 6 axes • Application-specific combination of components • Use of the latest innovations and technologies • Fully tested, with test certificate • Ready-to-install • Complete documentation • Design conforms to: <ul style="list-style-type: none"> – EN 60204-1 – ATEX zone 1 and 21 (pneumatic only), ATEX zone 2 and 22 (electric and electropneumatic) – UL-508 A • Implementation of safety functions • Wide range of bus technologies • Function modules for motion applications • Host modules for easy connection to the customer's control environment
Description	<ul style="list-style-type: none"> • Made-to-measure control cabinets • Pneumatic, electric, combined • Individually configured • Adapted to requirements in industrial automation • Design and sizing included 	<ul style="list-style-type: none"> • Made-to-measure control cabinets • Pneumatic, electric, combined • Individually configured • Adapted to requirements in process automation • Design and sizing included 	<ul style="list-style-type: none"> • Made-to-measure control cabinets for handling systems • Software package for third-party devices included • Individually configurable • Adapted to requirements for handling solutions → chapter 6 „Handling systems“ on page 75
online: →	Ready-to-install solutions	Ready-to-install solutions	Ready-to-install solutions

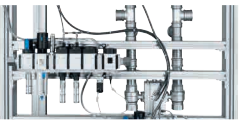
Mounting and installation plates



	 Mounting plates	 Hall installation plates (HIP) for body assembly	 Robot installation plates (RIP) for body assembly
Technical data	<ul style="list-style-type: none"> • Customised support plate shape • Support plate available in different materials • Application-specific combination of components • Fully assembled, connected and wired • Defined interfaces • Ready-to-install • Fully tested, with test certificate • Complete documentation • Design conforms to: <ul style="list-style-type: none"> – EN 60204-1 – ATEX zone 1 and 21 (pneumatic only), ATEX zone 2 and 22 (electric and electropneumatic) – UL-508 A • Implementation of safety functions 	<ul style="list-style-type: none"> • Media supply for compressed air and cooling water for welding cells • Made to measure: profile as support element, design perfectly adapted to the installation space, for installation within safety barriers • Labelling: customised labelling for safe operation • Fast installation: thanks to assembly according to the customer's specification • Medium water: fittings for liquid media 	<ul style="list-style-type: none"> • Media supply for compressed air and cooling water for welding robots • Protection against ambient conditions through the use of special materials, such as hoses and fittings resistant to welding spatter • Protection against environmental influences to prevent damage to the installation • Made to measure: profile as support element, design perfectly adapted to the installation space • Cooling water suction cylinder for drawing in cooling water when changing welding caps • Water flow sensor: measures flow rate, volume and cooling water temperature – to monitor the welding process • Easy to maintain thanks to removable fittings
Description	<ul style="list-style-type: none"> • Machine-specific pre-assembly of pneumatic and electric components on support plate • Tubing and wiring included • Defined interfaces for simple installation directly in the system 	<ul style="list-style-type: none"> • Controls and monitors the compressed air and cooling water supply for whole welding cells 	<ul style="list-style-type: none"> • Controls and monitors the compressed air and cooling water supply for individual welding guns
online: →	Ready-to-install solutions	www.festo.com/sp/hip	www.festo.com/sp/rip

Software tools



Festo Design Tool 3D		<p>The Festo Design Tool 3D is a 3D product configurator for generating specific CAD product combinations from Festo. The configurator makes your search for the right accessory easier, more reliable and faster.</p> <p>You can then order the module that has been created as a single order item, either completely pre-assembled or as individual parts in a single box. This considerably reduces your bill of materials, and downstream processes such as product ordering, order picking and assembly are significantly simplified.</p> <p>This tool can be found at → www.festo.com/x/festo-design-tool</p>
-----------------------------	---	--

Product overview

Modules

	 Modules	 Cartridge solutions	 Sheet-metal constructions and special housings
Technical data	<ul style="list-style-type: none"> • Combination of various pneumatic and/or electric components to create a single unit • Application-specific combination of components • Accessories mounted on sub-assembly • Use of the latest innovations and technologies • Ready-to-install • Fully tested, with test certificate • Complete documentation • Design conforms to: <ul style="list-style-type: none"> – EN 60204-1 – ATEX zone 1 and 21 (pneumatic only), ATEX zone 2 and 22 (electric and electropneumatic) – UL-508 A • Implementation of safety functions 	<ul style="list-style-type: none"> • Space-saving thanks to extremely compact design • Pneumatic functions integrated in a single compact housing • Housing in different materials • No tubing required • Minimal cabling required • Significant design freedom • Flexible integration options on and within the machine • Sturdy design • Fully tested • Ready-to-install • Complete documentation 	<ul style="list-style-type: none"> • Sheet-metal structures <ul style="list-style-type: none"> – Customised shape and size – Reduced weight and number of assembly parts • Special housing <ul style="list-style-type: none"> – Customised shape – Customised dimensions – Various materials – Compact, space-saving format – Protection against environmental influences and unauthorised access • In combination <ul style="list-style-type: none"> – Alternative to conventional control cabinets – Variable integration options on and within the machine – Short tubing and cable lengths – Attractive design
Description	<ul style="list-style-type: none"> • Pneumatic and electric components pre-assembled to create a function unit • Can be combined from around 30,000 catalogue components • Connections included • For integration in machines 	<ul style="list-style-type: none"> • Integration of various pneumatic functions in one component • No need for single housings • Ideal for applications that require a highly compact design 	<ul style="list-style-type: none"> • Reduced weight thanks to optimal use of materials with sheet-metal structures • Protection against environmental influences and unauthorised access in the special housing • Ideally combined as a control cabinet directly in the system
online: →	Ready-to-install solutions	Ready-to-install solutions	Ready-to-install solutions

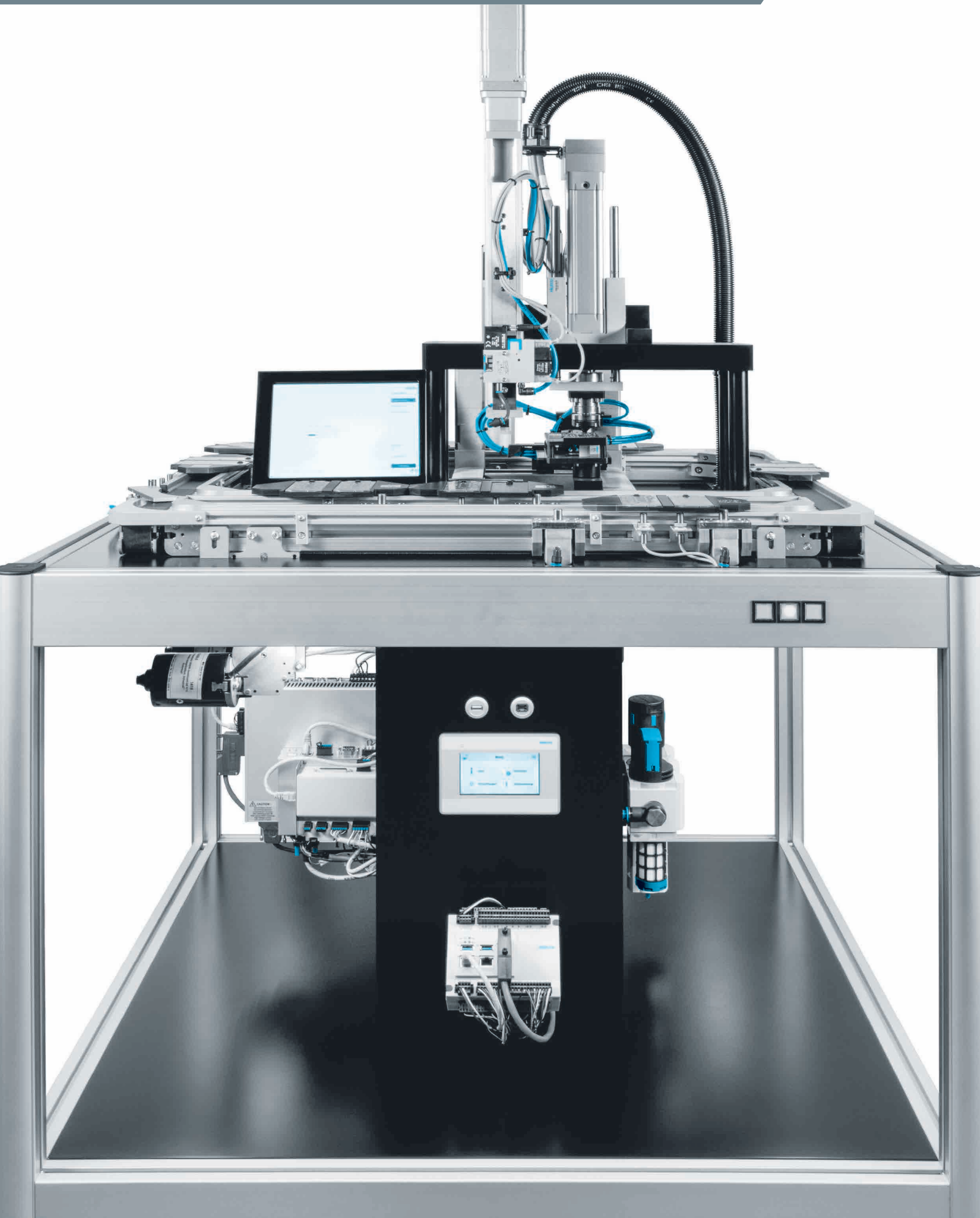

Modules

	 Function blocks	 Profile solutions
Technical data	<ul style="list-style-type: none"> • No tubing required thanks to drilled ducts • Housing available in different materials • Customised design of the pneumatic interfaces for the system • Ideal for a small number of components and variable connection options • Extremely economical, even for small quantities 	<ul style="list-style-type: none"> • Profiles in customised cross sections and lengths • Integrated ducts for straight-line routing of the compressed air • Common air supply for multiple valves or valve terminals via a single duct • Combination of exhaust air and supply air without tubing, even over long distances • Supply of compressed air at different locations • No tubing required • Significantly reduced cabling • Modular structure easy to achieve • Optional: profile as mechanical mounting element for other components or as a supporting part of the machine frame
Description	<ul style="list-style-type: none"> • Compressed air supply for pneumatic components via drilled ducts • Ideal for a small number of pneumatic components and variable connection options • Compact and easy to service 	<ul style="list-style-type: none"> • Extruded profiles in combination with valves as a valve terminal • For the distribution of compressed air in the machine concept • Customised profile cross sections available
online: →	Ready-to-install solutions	Ready-to-install solutions



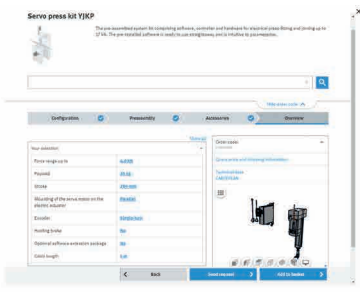

Product overview

Software tools



<p>Configurator</p> 	<p>Design a product with numerous features reliably and quickly with the help of the configurator.</p> <p>Select all the required product features step-by-step. The use of logic checks ensures that only correct configurations are available for selection.</p> <p>A dynamic graphic generated on the basis of the configuration provides a visual aid for selecting the correct product features.</p> <p>You will find the configurator</p> <ul style="list-style-type: none"> • at www.festo.com/catalogue/yjpk • Click on the product • Click on the blue “Configure product” button
<p>CODESYS</p> 	<p>CODESYS for standardised programming of embedded devices to IEC 61131-3 makes your life easier with simple commissioning, fast programming and parameterisation.</p> <p>Benefits</p> <ul style="list-style-type: none"> • Hardware-neutral software platform for quick and easy configuration, programming and commissioning of pneumatic and electric automation solutions • Extensive module libraries for single- or multi-axis positioning motions. • The IEC 61131-3 standard means that CODESYS is flexible and open for all types of control tasks. • Modular: offline and online functions as well as components for hardware configuration and visualisation. • Convenient IEC function block extension • Re-use of existing application parts <p>The parameterisation software can be found at</p> <ul style="list-style-type: none"> • www.festo.com > Support > assembly and commissioning > programming

Joining technology

Function-specific systems

	 <p>Servo press kits YJKP</p>	 <p>Commissioning service GFCA-Y2</p>
Working stroke	100 ... 400 mm	
Pressing force	0 ... 17 kN	
Feed speed	0 ... 250 mm/s	
Accuracy in ± % FS	0.25 %FS	
Protocol	EtherNet/IP, OPC UA, PROFINET IO, TCP/IP, Modbus® TCP	
Description	<ul style="list-style-type: none"> • Modular system kit comprising application software GSAY, electric cylinder, servo motor, motor controller, force sensor and controller together with the required accessories • Less expensive than conventional press-fitting systems • Pre-installed application software GSAY offers precisely the required application-specific functions • Commissioning made easy: parameterisation instead of programming • For top quality: real-time monitoring of the press-fitting operation and clear visualisation of the force/displacement curves • Fit for Industry 4.0 thanks to the OPC UA interface at the controller 	<ul style="list-style-type: none"> • Commissioning services for the servo press kit YJKP • Available remotely or on site • Support with commissioning • Support with electrical installation • Checking the electrical connections and the travel path • Configuration and parameterisation • Testing the system, data backup and documentation • Introduction to WebVisu software
online: →	yjpk	gfca

Handling solutions

	 <p>Balancer kits YHBP</p>	 <p>Control systems CMCB</p>	NEW
Stroke range	100 ... 1990 mm		
Cylinder diameter	50 ... 200 mm		
Max. travel speed	1 m/s		
Load	25 ... 999 kg		
Operating pressure [MPa]	0.4 ... 0.8 MPa		
Operating pressure	4 ... 8 bar		
Nominal operating voltage DC	24 V	24 V	
Design		Mounting plate, Control cabinet, Built-in safety relay unit	
Electrical connection		Spring-loaded terminal, Push-in	
Nominal operating voltage AC		230 V	
Max. current consumption		1100 mA	
Performance level (PL)		Category B, Performance Level b, Category 3, Performance Level d	
NEW		<ul style="list-style-type: none"> • New product, 11/2021 	
Description	<ul style="list-style-type: none"> • Very low operating forces of just 10 N • For applications involving the movement of heavy loads in defined, repetitive sequences • Extremely fast, automatic weight detection for a wide range of variants in production processes • With safety functions • The individual components are delivered mounted in the control cabinet, on a mounting plate or unassembled 	<ul style="list-style-type: none"> • Ready-to-install control system • Available on a mounting plate with or without control cabinet housing • Variants with safety functions • Adapted for balancer kit YHBP • With connecting cables for balancer kit YHBP connected 	
online: →	yhbp	cmcb	



Product overview







Product overview

Air reservoir



Air reservoirs

		
	Air pressure reservoirs VZS	Air pressure reservoirs CRVZS
Volume	20 l	0.1 l, 0.4 l, 0.75 l, 10 l, 2 l, 20 l, 5 l
Information on air reservoir materials	Powder-coated steel	High-alloy stainless steel
Conforms to standard	EN 286-1	AD 2000
Condensate drain connection	G3/8	G3/8
Description	<ul style="list-style-type: none"> • Compensation of pressure fluctuations and as accumulators in the event of sudden air consumption • Providing large quantities of compressed air for supplying fast pulsing drives • With connection for condensate drain • Conforms to the requirements of Directive 2014/29/EC and EN 286-1 • Operating medium: compressed air, vacuum 	<ul style="list-style-type: none"> • Corrosion-resistant • Compensation of pressure fluctuations and as accumulators in the event of sudden air consumption • Providing large quantities of compressed air for supplying fast pulsing drives • With connection for condensate drain in some cases • Food-safe, see www.festo.com/catalogue/crvzs > "Support / Downloads" tab > "Certificates" • Designs to EU Pressure Equipment Directive EN 286-1 • Operating medium: compressed air, vacuum
online: →	vzs	crvzs



				
	Silencers AMTE ★	Silencers U ★	Silencers UC	Silencers AMTC
Information on silencer insert materials	Bronze	PE, Bronze	PE	PE
Pneumatic connection	10-32 UNF-2A, 1/8 NPT, 1/4 NPT, 3/8 NPT, 1/2 NPT, G1, G1/2, G1/4, G1/8, G3/4, G3/8, M3, M5	3/4 NPT, G1, G1/2, G1/4, G1/8, G3/4, G3/8, PK-3, PK-4	G1/4, G1/8, G3/8, M5, M7, QS-10, QS-3, QS-4, QS-6, QS-8	Cartridge 10 mm
Noise level	55 ... 95 dB(A)	70 ... 90 dB(A)	58 ... 68 dB(A)	58 dB(A)
Description	<ul style="list-style-type: none"> • Long or short design • Metal version • Operating medium compressed air • High temperature resistance up to 80°C • Slim width • Many different variants • Universal applications 	<ul style="list-style-type: none"> • Compact design, polymer or die-cast • Barbed fitting or threaded connection • Operating medium compressed air 	<ul style="list-style-type: none"> • For noise reduction and prevention of contamination at exhaust ports of pneumatic components • Polymer version • Operating medium compressed air • For solenoid valves CPE • Threaded connection or push-in sleeve for push-in fitting QS 	<ul style="list-style-type: none"> • Attached via pin (spring clip, included in the delivery of the valve) • Polymer version • Operating medium compressed air
online: →	amte	u	uc	amtc

Silencers

Pneumatic silencers



			
	Silencers UO	Silencers UOS-1, UOS-1-LF	Silencers UOM, UOMS
Information on silencer insert materials	PE	PE	PU foam
Pneumatic connection	G1/4, G1/8, M5, M7	G1	G1/4, G3/8
Noise level			
Description	<ul style="list-style-type: none"> • Special open minimal resistance silencer • For vacuum generators • Facilitates trouble-free operation of the vacuum generator • Operating medium compressed air 	<ul style="list-style-type: none"> • Silencer for MS6-SV, MS series • Operating medium compressed air 	<ul style="list-style-type: none"> • Special open minimal resistance silencer • For vacuum generators • Facilitates trouble-free operation of the vacuum generator • Silencer extension for extending the silencer for further noise reduction • Operating medium compressed air
online: →	uo	uos	uom

Compressed air pistols



		
	Air guns LSP	Air nozzles LPZ
Exhaust air function	Metered blowing	
Pneumatic connection	Female thread G1/4	Male thread M12x1.25
Information on housing materials	Wrought aluminium alloy, PA6 reinforced	Aluminium, Brass, Die-cast zinc, Chrome-plated, Nickel-plated
Description	<ul style="list-style-type: none"> • Precise, infinitely variable, lever-operated flow metering • Interchangeable nozzles • Operating medium compressed air 	<ul style="list-style-type: none"> • With protective air shield or silencer • Targeted, strong air jet or powerful, focused air jet • Low noise level • Operating medium compressed air
online: →	lsp	lpz

Product overview

Pressure indicators

	 <p>Visual indicators OH</p>	 <p>Pneumatic terminals, end clamps, distributors LT, LTE, LTV</p>
Operating pressure [MPa]	-0.1 ... 0.8 MPa	
Operating pressure	-1 ... 8 bar	0.1 ... 8 bar
Pneumatic connection	Barbed connector PK-3, G1/8	Barbed connector PK-3, PK-4
Pneumatic connection 2		For tubing O.D. 4 mm, 6 mm
Type of mounting	Installation into control panel in Ø22.5	
Description	<ul style="list-style-type: none"> • Visual indicator • Indicator colours red, blue, yellow or green • Aluminium or polymer • Operating medium compressed air 	<ul style="list-style-type: none"> • Pneumatic terminal for checking incoming and outgoing signals at the controller input and output • Up to 15 distributor pieces with common air supply, for easy connection • Brass, polymer • Operating medium compressed air
online: →	oh	lt

Inscription systems

	 <p>Inscription labels ASLR, BZ, HWF, IBS, KM, KMC, MH, SBS</p>	 <p>Inscription label holders ASCF, CPV10-VI-ST, CPV14-VI-ST, CPV18-VI-ST, CPVSC1-ST, CPX-ST, VMPA1-ST, VMPA14-ST, VMPAL-ST</p>
Type of mounting	Can be pressed in manually	Plug-on, snap-in, clip-on
Width		21 mm, 12 mm
Height		7 mm, 2 mm
Description	<ul style="list-style-type: none"> • For labelling items • Can be inserted in holders or carriers on suitably equipped components 	<ul style="list-style-type: none"> • Holder for inscription labels • For components without pre-assembled carriers
online: →	aslr	ascf



Product overview

Control technology and remote I/O





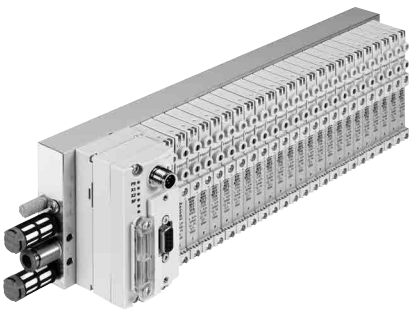

- Electronic controllers and remote I/Os including electrical peripherals for standard and potentially explosive atmospheres.
www.festo.com/pa/control

Valve terminals





- Valve modules with electrical multi-pin, individual or fieldbus connection or integrated controller, with or without electrical inputs and outputs
www.festo.com/pa/valveterminals

Pilot valves



	 Solenoid valves VSNC	 Standards-based valves, NAMUR (VDI/VDE 3845) NVF3	 Solenoid valves VOFC	 Solenoid valves VOFD
Valve function	5/2 double solenoid, 5/2-way or 3/2-way, convertible, 5/3-way, pressurised, 5/3 exhausted, 5/3 closed	5/2- or 3/2-way monostable	3/2-way, closed, monostable, 5/2 double solenoid, 5/2-way, monostable	3/2-way, closed, monostable, semi-automatic, 3/2-way, closed, monostable
Operating pressure [MPa]		0.2 ... 1 MPa	0 ... 1 MPa	0 ... 1.2 MPa
Operating pressure	1.5 ... 10 bar	2 ... 10 bar	0 ... 10 bar	0 ... 12 bar
Ambient temperature	-20 ... 60°C	-5 ... 40°C	-25 ... 60°C	-50 ... 60°C
Pneumatic connection 1	1/4 NPT, G1/4, QS-1/4, QS-10, QS-3/8, QS-5/16, QS-6, QS-8	G1/4	1/4 NPT, 1/2 NPT, NAMUR port pattern, G1/2, G1/4	1/4 NPT, NAMUR port pattern, G1/4, 1/2 NPT, G1/2
Standard nominal flow rate	800 ... 1350 l/min	900 l/min	595 ... 2794 l/min	52 ... 1900 l/min
Explosion prevention and protection	Zone 0 (KR), Zone 1 (ATEX), Zone 2 (ATEX), Zone 21 (ATEX), Zone 22 (ATEX), Zone 0 (IEC-EX), Zone 1 (IEC-EX), Zone 20 (IEC-EX), Zone 21 (IECEX), Zone 1 (KR), Zone 2 (KR), Zone 21 (KR), Zone 22 (KR), Class I, Div. 1 (US), Class I, Div. 2 (US), Class II, Div. 1 (US), Class II, Div. 2 (US), Class III, Div. 1 (US), Class III, Div. 2 (US)	Zone 1 (ATEX), Zone 2 (ATEX), Zone 21 (ATEX), Zone 22 (ATEX)	Zone 1 (ATEX), Zone 2 (ATEX), Zone 21 (ATEX), Zone 22 (ATEX), Zone 1 (IEC-EX), Zone 21 (IECEX), Zone 1 (KR), Zone 21 (KR)	II 2G, II 2D, for zone 1, 2, 21, 22, Ex d IIC T6, T5, T4 Gb, Ex eb mb IIC T6, T5 Gb
Safety integrity level (SIL)			Up to SIL 2 High Demand mode, To SIL 2 Low Demand mode, Up to SIL 3 High Demand mode, To SIL 3 Low Demand mode	Up to SIL 3 High Demand mode, To SIL 3 Low Demand mode
Description	<ul style="list-style-type: none"> Namur connection pattern to VDI/VDE 3845 Rotatable seal for 3/2- or 5/2-way valve Wide choice of EX solenoid systems Sturdy and powerful Extended temperature range Excellent value for money All solenoid coils can be used on an armature tube The VSNC...FN variant achieves greater energy efficiency with reduced power consumption 	<ul style="list-style-type: none"> Namur connection pattern to VDI/VDE 3845 Electrically actuated, piloted Reset via mechanical return Variants to EU Explosion Protection Directive (ATEX) 	<ul style="list-style-type: none"> Suitable for process automation in the chemical and petrochemical industries Suitable for outdoor use under harsh ambient conditions Especially suitable for quarter turn actuators thanks to NAMUR flange pattern Valve can switch between internal and external pilot air Variants with safety functions Variants to EU Explosion Protection Directive (ATEX) 	<ul style="list-style-type: none"> Suitable for process automation in the chemical and petrochemical industries Suitable for outdoor use under harsh ambient conditions Especially suitable for quarter turn actuators thanks to NAMUR flange pattern Variants with safety functions Variants to EU Explosion Protection Directive (ATEX)
online: →	vsnc	namur	vofc	vofd

Product overview

Sensor boxes

			
	End switch attachments SRBC	★ End switch attachments SRBG	End switch attachments SRBE
Information on housing materials	Die-cast aluminium	PBT	Die-cast aluminium
Operating voltage range AC	0 ... 250 V		0 ... 250 V
Operating voltage range DC	0 ... 175 V	6 ... 60 V	0 ... 60 V
Measuring principle	Inductive, Magnetic reed, Mechanical/ electrical	Inductive	Inductive, Magnetic reed, Mechanical/ electrical, Via proximity switch
Switching element function	N/C contact, N/O contact, Toggle switch, single-pole	N/C contact, N/C or N/O contact, switchable, N/O contact	N/C contact, N/O contact, Toggle switch, single-pole, Toggle switch, double-pole
Safety integrity level (SIL)	SIL 2	SIL 2	SIL 2
Description	<ul style="list-style-type: none"> • Pre-assembled mounting adapter for ease of installation • The trip cams can be easily set without additional tools • Sturdy, corrosion-resistant design, ideal for use in harsh ambient conditions • Clearly visible 3D position indicator allows the current position of the quarter turn actuator to be quickly detected • With safety functions • Variants to EU Explosion Protection Directive (ATEX) 	<ul style="list-style-type: none"> • Compact housing with M12 plug connection • Direct mounting on quarter turn actuators to VDI/VDE 3845 • For quarter turn actuators for process automation with position indicators • AS-Interface version with extended addressing options • LED status indicator for switching status, supply voltage and solenoid valve output • With safety functions • Variants to EU Explosion Protection Directive (ATEX) 	<ul style="list-style-type: none"> • The trip cams can be easily set without additional tools • Sturdy, corrosion-resistant design, ideal for use in harsh ambient conditions • Clearly visible 3D position indicator allows the current position of the quarter turn actuator to be quickly detected • With safety functions • To EU Explosion Protection Directive (ATEX)
online: →	srbc	srbg	srbe



Sensor boxes

			
	Limit switch attachments SRAP	Limit switch attachments DAPZ	Limit switch box SRBI
Information on housing materials	Wrought aluminium alloy		PBT
Operating voltage range AC		4 ... 250 V	
Operating voltage range DC	15 ... 30 V	4 ... 250 V	10 ... 30 V
Measuring principle	Magnetic Hall	Inductive, Mechanical/electrical	Inductive
Switching element function		N/O contact, Changeover switch	N/O contact
Safety integrity level (SIL)			
Description	<ul style="list-style-type: none"> • Based on standard VDI/VDE 3845 (NAMUR) • Analogue • For monitoring the position of quarter turn actuators • Sensors based on 2D Hall technology • Variants to EU Explosion Protection Directive (ATEX) 	<ul style="list-style-type: none"> • Round design • Drive interface to standard VDI/VDE 3845 (NAMUR) • With display • Integrated solenoid valve control 	<ul style="list-style-type: none"> • Compact housing with M12 plug connection • Direct mounting on quarter turn actuators to VDI/VDE 3845 • For quarter turn actuators for process automation with position indicators • LED status indicator for switching status and supply voltage
online: →	srap	dapz	srbi

Accessories for sensor boxes

	 <p>Position indicators SASF</p>
Setting range of swivel angle	0 ... 360 deg
Ambient temperature	-40 - 80°C
Type of mounting	To VDI/VDE 3845
Description	<ul style="list-style-type: none"> • For limit switch attachments SRBG, SRBI, SRBC • Variants for mounting on drive shafts of standard drives according to VDI/VDE 3845 • Variants with adjustable swivel angle • Variants for clockwise and anticlockwise rotating actuators with 90° and 180° rotation • Variants with position indicator in yellow/red, I-, T-, L-design or with 180° arrow
online: →	sasf





Positioners

	 <p>Positioner CMSH</p>	 <p>Positioners CMSX</p>	★
Mode of operation	Double-acting, Single-acting	Double-acting, Single-acting	
Standard nominal flow rate		50 ... 130 l/min	
Ambient temperature	-40 ... 80°C	-5 ... 60°C	
Reference value		0...10 V/0...20 mA/4...20 mA	
Operating voltage range DC		21.6 ... 26.4 V	
Operating pressure [MPa]	0.14 ... 0.8 MPa	0.3 ... 0.8 MPa	
Operating pressure	1.4 ... 8 bar	3 ... 8 bar	
Operating pressure [psi]	20.3 ... 116 psi	43.5 ... 116 psi	
Design features	Safety position - pneumatic outlets closed, Safety pneumatic output 4 pressurised, Safety pneumatic output 2 exhausted	Safety position – pneumatic outlet 4 exhausted, Safety position – pneumatic outlet 2 pressurised, Safety position - pneumatic outlets closed	
Degree of protection	IP66, IP67	IP65	
Type of mounting	With accessories, To VDI/VDE 3845, To VDI/VDE 3847-2	With accessories	
Information on housing materials	Aluminium, powder-coated	PC-reinforced	
Description	<ul style="list-style-type: none"> • Intelligent, digital electropneumatic positioner with HART communication • Fast and precise position control of single- and double-acting pneumatic rotary and linear drives • With integrated or external path/angular detection • Commissioning, operation, maintenance and diagnostics on the local display via the user-friendly software menu or via remote access with EDD-based (Electronic Device Description) or FDT-based (Field Device Tool) transmission • 2-conductor technology • Perfect interaction with the pneumatic extension modules VTOP • Variants with safety functions • Sustainable operation thanks to efficient control 	<ul style="list-style-type: none"> • Digital, electropneumatic positioner • Simple and efficient position control of single- and double-acting pneumatic rotary and linear drives • With integrated or external path/angular detection • Simple commissioning through automatic initialisation function • Intuitive menu navigation • 4-conductor technology • Variants with safety functions 	
online: →	cmsH	cmsX	

Product overview

Drives >

Linear actuators

	 Linear actuators DFPC	 Piston drives DFPK	 Linear actuators with displacement encoder DFPI	 Linear actuators with displacement encoder DFPI-NB3
Design	Piston, Piston rod, Tie rod, Cylinder barrel		Piston, Piston rod, Tie rod, Cylinder barrel	Piston, Piston rod, Tie rod, Cylinder barrel
Mode of operation	Double-acting		Double-acting	Double-acting
Size of valve actuator	80, 100, 125, 160, 200, 250, 320	46, 75	100, 125, 160, 200, 250, 320	100, 125, 160, 200, 250, 320
Stroke	10 ... 1600 mm	17 ... 20 mm	40 ... 990 mm	40 ... 990 mm
Operating pressure [MPa]	0.06 ... 0.8 MPa	0.5 ... 1 MPa	0.3 ... 0.8 MPa	0.3 ... 0.8 MPa
Operating pressure	0.6 ... 8 bar	5 ... 10 bar	3 ... 8 bar	3 ... 8 bar
Operating pressure [psi]	8.7 ... 116 psi	72.5 ... 145 psi	43.5 ... 116 psi	43.5 ... 116 psi
Ambient temperature	-20 ... 80°C	0 ... 60°C	-20 ... 80°C	-20 ... 80°C
NEW	<ul style="list-style-type: none"> New for 07/2021: additional versions 			
Description	<ul style="list-style-type: none"> Robust and corrosion-resistant tie-rod design Ideal for use in harsh ambient conditions Numerous configuration options Variants with fastening interface in accordance with ISO 5210 or ISO 15552 with extended tie rods 	<ul style="list-style-type: none"> Stainless steel design Available as a valve actuator with angle seat valve VZXA and as a valve block solution Linear actuating motion High actuating forces To EU Explosion Protection Directive (ATEX) 	<ul style="list-style-type: none"> Mounting interfaces for process valves to DIN EN ISO 5210 Integrated air supply Optionally with integrated displacement encoder or fully integrated positioner IP65, IP67, IP69K, NEMA4 To EU Explosion Protection Directive (ATEX) 	<ul style="list-style-type: none"> Mounting interfaces to ISO 15552 on bearing and end caps Robust and corrosion-resistant tie-rod design Optionally with integrated displacement encoder or fully integrated positioner IP65, IP67, IP69K, NEMA4 To EU Explosion Protection Directive (ATEX)
online: →	dfpc	dfpk	dfpi	dfpi

Software tools

Configurator for quarter turn actuator units KDFP





Choose just an actuator unit without process valve for automating existing process valves. Simply enter the required parameters on the input screen and the configurator will suggest suitable solutions.

You can find the configurator at

- www.festo.com/process

Drives >



Quarter turn actuators for process valves

	 Quarter turn actuator units KDFP-DFPD	 Quarter turn actuators DFPD	 Quarter turn actuators with heavy-duty guide DFPD-HD
Design	Rack and pinion	Rack and pinion	Scotch yoke system
Mode of operation	Double-acting, Single-acting	Double-acting, Single-acting	Double-acting, Single-acting
Size of valve actuator	120, 80, 10, 20, 300, 240, 40, 900, 160, 2300, 700, 1200, 480	10, 20, 40, 80, 120, 160, 240, 300, 480, 700, 900, 1200, 2300	9000, 18000, 32000
Flange hole pattern	F12, F10, F07, F14, F16, F05, F04, F03	F03, F04, F05, F07, F10, F12, F14, F16, F0507, F0710, F1012, F1216	F25, F30, F35
Swivel angle	90 deg	90 deg, 120 deg, 135 deg, 180 deg	90 deg
Operating pressure [MPa]	0.2 ... 0.8 MPa	0.2 ... 0.8 MPa	0.1 ... 0.85 MPa
Operating pressure	2 ... 8 bar	2 ... 8 bar	1 ... 8.5 bar
Operating pressure [psi]	29 ... 116 psi	29 ... 116 psi	14.5 ... 123.25 psi
Ambient temperature	-50 ... 150°C	-50 ... 150°C	-20 ... 80°C
Safety function		The fundamental safety function consists of the execution of a complete working stroke (opening and closing of the process valve) within a defined time., The fundamental safety function consists of the control valve moving to the switching position when the compressed air is turned off. It is reset by spring force.	
Safety integrity level (SIL)		Up to SIL 2 High Demand mode, To SIL 2 Low Demand mode, Up to SIL 3 in a redundant architecture, Up to SIL 1 high demand mode	
Description	<ul style="list-style-type: none"> • Quarter turn actuator unit comprising quarter turn actuator DFPD and accessories • Select, size and order quickly, easily and reliably with the configurator • Optionally with pilot valve • Optionally with positioner • Optional with position indicator • Optionally with end position feedback • Optionally with the required mounting adapters or reducing sleeves for mounting on the valve body 	<ul style="list-style-type: none"> • Uniform torque characteristic across the entire rotation angle of 90° with the double-acting version • Process valve connection to ISO 5211 • Mounting hole pattern to VDI/VDE 3845 • Sturdy, non-slip and easy-to-clean aluminium housing • Long service life, low wear • Version with swivel angle 120°, 135°, 180° for the sizes 40, 120, 240, 480, double-acting • Variants with safety functions • To EU Explosion Protection Directive (ATEX) 	<ul style="list-style-type: none"> • Ideal for applications with high torques up to max. 32,000 Nm • Extremely modular for a variety of uses: configurable spring forces, a choice between right or left direction of rotation and mechanical or hydraulic manual override • With safety functions • Namur connection pattern to VDI/VDE 3845 • Variants to EU Explosion Protection Directive (ATEX)
online: →	kdfp	dfpd	dfpd

Product overview

Drives >

Quarter turn actuators for process valves

		
	Quarter turn actuators DFPD-C	Quarter turn actuators DAPS
Design	Rack and pinion	Scotch yoke system
Mode of operation	Single-acting	Double-acting, Single-acting
Size of valve actuator	20, 40, 80, 120, 160, 240, 300, 480, 700, 900, 1200, 2300	0008, 0015, 0030, 0053, 0060, 0090, 0106, 0120, 0180, 0240, 0360, 0480, 0720, 0960, 1440, 1920, 2880, 3840, 4000, 5760, 8000
Flange hole pattern	F05, F07, F10, F12, F14, F16	F03, F04, F05, F07, F10, F12, F14, F16, F25
Swivel angle	90 deg	90 deg, 92 deg
Operating pressure [MPa]	0.2 ... 0.8 MPa	0.1 ... 0.84 MPa
Operating pressure	2 ... 8 bar	1 ... 8.4 bar
Operating pressure [psi]	29 ... 116 psi	
Ambient temperature	-20 ... 80°C	-50 ... 150°C
Safety function	The fundamental safety function consists of the control valve moving to the switching position when the compressed air is turned off. It is reset by spring force.	
Safety integrity level (SIL)	To SIL 2 Low Demand mode, Up to SIL 3 in a redundant architecture, Up to SIL 1 high demand mode	Up to SIL 2 High Demand mode, To SIL 2 Low Demand mode
Description	<ul style="list-style-type: none"> • Suitable for process automation in the chemical and petrochemical industries • Extended NAMUR interface to VDI/VDE 3847 • Anti-blow-out screws for end-position adjustment • Hard anodised cover to prevent surface damage • Non-ferrous metal-free spring sets • Version with compressed air ducts in the housing for direct attachment of positioner and pilot valve on the actuator, without extra barbed tubing connectors 	<ul style="list-style-type: none"> • High breakaway torques • Flange hole pattern to ISO 5211 • Mounting hole pattern to VDI/VDE 3845 • Optionally with handwheel as a manual emergency override • Corrosion-resistant version made from stainless steel • To EU Explosion Protection Directive (ATEX) • With safety functions
online: →	dfpd	daps

Software tools

Process Valve Automation Tool (PVA-Tool) engineering software



User-friendly software for sizing and selecting the appropriate quarter turn actuators for automating butterfly and ball valves





The torque curve of the selected actuator will be displayed for visual confirmation. The specifications for the application can be changed at any time and the results will be automatically adjusted in line with the new requirements.

You can find the engineering software at

- www.festo.com/x/engineering

Process valves >



Ball valves

	 Ball valves VZBD	 Ball valves VZBE	 Ball valves VZBF	 Ball valves VZBM
Design	2-way ball valve	2-way ball valve, 2-way ball valve with hand lever, 3-way ball valve, L-hole, T-hole	2-way ball valve	2-way ball valve, 3-way ball valve, L-hole, T-hole
Actuation type	Mechanical	Mechanical	Mechanical	Mechanical
Nominal size DN	15, 20, 25, 32, 40, 50, 65, 80, 100	8, 10, 15, 20, 25, 32, 40, 50, 65, 80, 100	15, 20, 25, 32, 40, 50, 65, 80, 100, 150, 200	8, 10, 15, 20, 25, 32, 40, 50
Process valve connection	Clamp to ASME-BPE, Clamp to DIN 32676 series B, Weld-on end to ASME-BPE, Weld-on end to ISO 1127	1 NPT, 1 1/2 NPT, 1 1/4 NPT, 1/2 NPT, 1/4 NPT, 2 NPT, 2 1/2 NPT, 3 NPT, 3/4 NPT, 3/8 NPT, 4 NPT, Weld-on end according to ASME B16.11	Flange to ANSI B16.5 class 150	Rp1, Rp1 1/2, Rp1 1/4, Rp1/2, Rp1/4, Rp2, Rp3/4, Rp3/8
Flow rate Kv	13 ... 1641 m3/h	5.1 ... 1637 m3/h	8.5 ... 7816 m3/h	5.9 ... 243 m3/h
Temperature of medium	-20 ... 200°C	-20 ... 200°C	-20 ... 200°C	-20 ... 130°C
Nominal pressure process valve PN	16	63	20	25, 40, 50
Description	<ul style="list-style-type: none"> • Electropolished surfaces SFV4 • PTFE seal with little dead space • The high-performance ball valve for the pharmaceutical and cosmetics industry • FDA-compliant seal to FDA 21 CFR 177.1550 	<ul style="list-style-type: none"> • 2-way manual, with lockable hand lever • 2- and 3-way with ISO 5211 hand flange, with optional lockable hand lever • Stainless steel design • Pipe thread according to ASME B1.20.1 or welded end according to ASME B16.11 • Optionally with pre-assembled hand lever 	<ul style="list-style-type: none"> • Flanged connections to ANSI B 16.5. class 150 • Static discharge ensured • API 607 Fire Safe certification • Stainless steel design • Easy to service • Optionally with pre-assembled hand lever 	<ul style="list-style-type: none"> • Brass design • Pipe thread to EN 10226-1
online: →	vzbd	vzbe	vzbf	vzbm

Product overview



Process valves >

Ball valves

	 Ball valves VAPB	 Ball valves VZBC	 Ball valves VZBA
Design	2-way ball valve	2-way ball valve	2-way ball valve, 3-way ball valve, L-hole, T-hole
Actuation type	Mechanical	Mechanical	Mechanical
Nominal size DN	15, 20, 25, 32, 40, 50, 63	15, 20, 25, 32, 40, 50, 65, 80, 100	8, 10, 15, 20, 25, 32, 40, 50, 65, 80, 100
Process valve connection	Rp1, Rp1 1/2, Rp1 1/4, Rp1/2, Rp1/4, Rp2, Rp2 1/2, Rp3/4, Rp3/8	Ring housing with threaded flange	Weld-on ends/weld-on ends, Rp1, Rp1 1/2, Rp1 1/4, Rp1/2, Rp1/4, Rp2, Rp2 1/2, Rp3, Rp3/4, Rp3/8, Rp4
Flow rate Kv	5.9 ... 535 m ³ /h	19.4 ... 1414 m ³ /h	7 ... 1414 m ³ /h
Temperature of medium	-20 ... 150°C	-10 ... 200°C	-10 ... 200°C
Nominal pressure process valve PN	25, 40	16, 40	63
Description	<ul style="list-style-type: none"> • Automatable 2-way ball valve • Brass design • Blow-out proof shaft • Manual operation possible using hand lever • Connecting thread to EN 10226-1 • Mounting flange to ISO 5211 	<ul style="list-style-type: none"> • Automatable 2-way compact flanged ball valve • Stainless steel design • Short installation length • Blow-out proof shaft • Manual operation possible using hand lever • Flange to DIN 1092-1 • Mounting flange to ISO 5211 • Use in zone 1, 21, 2, 22 	<ul style="list-style-type: none"> • Automatable 2-way or 3-way ball valve • Stainless steel design • Blow-out proof shaft • Manual operation possible using hand lever • Connecting thread to EN 10226-1 • Mounting flange to ISO 5211 • Use in zone 1, 21, 2, 22
online: →	vapb	vzbc	vzba

Process valves >

Angle seat valves

	 Angle seat valves VZXF	 Angle seat valves VZXA ★
Design	Poppet valve with piston drive	Poppet valve with piston drive, Poppet valve with diaphragm actuator
Drive size	50 mm, 80 mm	46 mm, 75 mm, 90 mm
Valve function	2/2-way, closed, monostable	2/2
Control function	Closed via reduced spring force, N/C	Closed via reduced spring force, N/C, Double-acting, Opened via spring force, N/O, Closed via spring force, N/C
Actuation type	Pneumatic	Pneumatic
Nominal size DN	12, 13, 16, 18, 23, 24, 29, 31, 35, 43, 45	13, 20, 25, 32, 40, 50, 65
Flow rate Kv	3.3 ... 43 m ³ /h	4.6 ... 77.9 m ³ /h
Medium pressure [MPa]	-0.09 ... 4 MPa	-0.09 ... 3 MPa
Medium pressure	-0.9 ... 40 bar	-0.9 ... 30 bar
Temperature of medium	-40 ... 200°C	-30 ... 200°C
Nominal pressure process valve PN	16, 40	25, 40
Description	<ul style="list-style-type: none"> • Sturdy design • Stainless steel and gunmetal process valves with stainless steel, brass or aluminium actuators • Different actuator sizes and housing materials • Selection of different seat and shaft seals • For liquids, gases and other easily contaminated media • Easy-to-clean design 	<ul style="list-style-type: none"> • Highly flexible, extremely high flow rates • Long service life • Stainless steel or Ecobrass process valves with stainless steel or polymer actuators • Modular design • Hygienic design, insensitive to dirt • Quick and easy maintenance • Simple and sturdy: an ideal choice for virtually all media with a viscosity of 600 mm²/s • High chemical and thermal resistance • Sustainable in production thanks to the use of alternative materials
online: →	vzxf	vzxa

Product overview

Process valves >

Pinch valves







Pinch valves
VZQA

Design	Pinch valve, pneumatically actuated
Actuation type	Pneumatic
Valve function	2/2-way, closed, monostable, 2/2 open, single solenoid
Nominal size DN	6, 15, 25
Process valve connection	Clamp to ASME-BPE, type A, Clamp to ASME-BPE, type B, Clamp to DIN 32676 series A, 1 NPT, 1/2 NPT, 1/4 NPT, G1, G1/2, G1/4
Flow rate Kv	0.7 ... 18 m ³ /h
Medium pressure [MPa]	0 ... 0.6 MPa
Medium pressure	0 ... 6 bar
Medium pressure [psi]	0 ... 87 psi
Temperature of medium	-5 ... 150°C
Nominal pressure process valve PN	10
Description	<ul style="list-style-type: none"> • Modular design • Quick and easy replacement of the diaphragm • For critical, abrasive and viscous media • Easy-to-clean design • Flow direction is freely selectable • Versions with end-position sensing
online: →	vzqa

Process valves >



Solenoid-actuated media valves

	 Solenoid valves VZWD ★	 Solenoid valves VZWF ★	 Solenoid valves VZWM ★	 Solenoid valves MN1H
Design	Directly actuated poppet valve	Diaphragm valve, Force pilot operated	Diaphragm valve, servo-controlled	Diaphragm valve
Actuation type	Electric	Electric	Electric	Electric
Nominal size	1 ... 6 mm	13.5 ... 50 mm	13 ... 50 mm	13 ... 40 mm
Process valve connection	1/4 NPT, 1/8 NPT, G1/4, G1/8, NPT1/4	1 NPT, 1 1/2 NPT, 1 1/4 NPT, 1/2 NPT, 1/4 NPT, 2 NPT, 3/4 NPT, 3/8 NPT, G1, G1 1/2, G1 1/4, G1/2, G1/4, G2, G3/4, G3/8	G1, G1 1/2, G1 1/4, G1/2, G1/4, G2, G3/4, G3/8	G1, G1 1/2, G1/2, G1/4, G3/4, G3/8
Flow rate Kv	0.06 ... 0.4 m3/h	1.8 ... 28 m3/h	1.6 ... 39 m3/h	
Medium pressure [MPa]	0 ... 9 MPa	0 ... 1 MPa		
Medium pressure	0 ... 90 bar	0 ... 10 bar		0.5 ... 10 bar
Medium pressure [psi]	0 ... 1305 psi	0 ... 145 psi		
Temperature of medium	-10 ... 80°C	-10 ... 80°C	-10 ... 60°C	-10 ... 60°C
Description	<ul style="list-style-type: none"> • Extensive pressure range • Directly actuated poppet valve • No differential pressure required • Can also be used in vacuum technology 	<ul style="list-style-type: none"> • High flow rates • Large nominal diameters with relatively small solenoids • No differential pressure required • Can also be used in vacuum technology 	<ul style="list-style-type: none"> • Brass or stainless steel casting design • Electrical connection via solenoid armature tube • Comprehensive range of coils • Coil can be ordered separately 	<ul style="list-style-type: none"> • Piloted diaphragm valve • Brass design • Can only be used for gaseous media • Adjustable closing cushioning, in-line mounting or through-hole • Operating voltage 24 V DC, 110/230 V AC (50 ... 60 Hz)
online: →	vzwd	vzwf	vzwm	mn1h-2

Product overview

Process valves >

Solenoid-actuated media valves

	 Solenoid valves VZWP	 Media separated solenoid valves VYKB	 Media separated solenoid valves VYKA
Design	Piloted piston poppet valve	Electrical connection at top, Electrical connection at the side, Rocker valve with diaphragm seal	Rocker valve with diaphragm seal
Actuation type	Electric	Electric	Electric
Nominal size	13 ... 25 mm	1.6 ... 2 mm	1.2 mm
Process valve connection	1 NPT, 1/2 NPT, 1/4 NPT, 3/4 NPT, 3/8 NPT, G1, G1/2, G1/4, G3/4, G3/8		
Flow rate Kv	1.5 ... 11.5 m3/h	0.034 ... 0.056 m3/h	0.013 ... 0.021 m3/h
Medium pressure [MPa]	0.05 ... 4 MPa	-0.075 ... 0.3 MPa	-0.025 ... 0.2 MPa
Medium pressure	0.5 ... 40 bar	-0.75 ... 3 bar	-0.25 ... 2 bar
Medium pressure [psi]	7.25 ... 580 psi	-10.875 ... 43.5 psi	-3.625 ... 29 psi
Temperature of medium	-10 ... 80°C	0 ... 50°C	
NEW		• New product, 5/2021	
Description	<ul style="list-style-type: none"> For all applications with a differential pressure of min. 0.5 bar For high pressures and high flow rates with relatively small solenoids For controlling gaseous and liquid media in open circuits 	<ul style="list-style-type: none"> Compact width of 10 mm or 12 mm Very easy to clean thanks to media separation High-quality materials, therefore also suitable for aggressive media Very flexible in use thanks to 3/2-way or 2/2-way variants as well as 12 or 24 V DC actuation For dosing, aspirating and for continuous flow applications Developed according to ISO 13485 Sustainable operation thanks to efficient control and active air shut-off 	<ul style="list-style-type: none"> Compact width of 7 mm Maximum performance and precision in the smallest of spaces High flow rate with small size Very easy to clean thanks to media separation Low media consumption thanks to small internal volume FDA-listed materials High-quality materials, therefore also suitable for aggressive media High repetition accuracy, switching frequency and precision, therefore also suitable for extremely small volumes and dosing tasks Very flexible in use thanks to 3/2-way and 2/2-way variants as well as 12 ... 26 V DC control Optionally with slide-on E-box VAVE-K1 with holding current reduction as accessory Developed according to ISO 13485 Sustainable operation thanks to efficient control and active air shut-off
online: →	vzwp	vykb	vyka

Software tools

Configurator for ball valve units KVZB



Size and order your custom ball valve units quickly, easily and reliably via the configurator – without waiting times.

You will receive configuration-specific datasheets and the relevant CAD data or CAD models.

You can find the configurator at

- www.festo.com/process



Process valve units >

Ball valve units

	Ball valve units KVZB
Description	<ul style="list-style-type: none"> Manually actuated with hand lever Automatically actuated with quarter turn actuator Controlled operation with quarter turn actuator and valve positioner Variants to EU Explosion Protection Directive (ATEX)
online: →	kvzb

Process valve units >

Ball valve actuator units

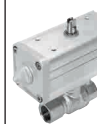
				
Ball valve actuator units VZBM	Ball valve actuator units VZBC	Ball valve actuator units VZBA	Ball valve actuator units VZPR	
Design	2-way ball valve, 3-way ball valve, Semi-rotary drive	2-way ball valve, Semi-rotary drive	2-way ball valve, 3-way ball valve, L-hole, Semi-rotary drive, T-hole	2-way ball valve, Semi-rotary drive
Actuation type	Pneumatic	Pneumatic	Pneumatic	Electric, Pneumatic
Nominal size DN	8, 10, 15, 20, 25, 32, 40, 50	15, 20, 25, 32, 40, 50, 65, 80, 100	8, 10, 15, 20, 25, 32, 40, 50, 65, 80, 100	15, 20, 25, 32, 40, 50, 63
Process valve connection	Rp1, Rp1 1/2, Rp1 1/4, Rp1/2, Rp1/4, Rp2, Rp3/4, Rp3/8	Ring housing with threaded flange	Weld-on ends/weld-on ends, Rp1, Rp1 1/2, Rp1 1/4, Rp1/2, Rp1/4, Rp2, Rp2 1/2, Rp3, Rp3/4, Rp3/8, Rp4	Rp1, Rp1 1/2, Rp1 1/4, Rp1/2, Rp1/4, Rp2, Rp2 1/2, Rp3/4, Rp3/8
Flow rate Kv	5.9 ... 243 m3/h	19.4 ... 1414 m3/h	7 ... 1414 m3/h	
Temperature of medium	-20 ... 130°C	-10 ... 200°C	-10 ... 200°C	-20 ... 150°C
Nominal pressure process valve PN	25, 40	16, 40	63	25, 40
Description	<ul style="list-style-type: none"> Ball valve actuator unit with double-acting or single-acting quarter turn actuator DFPD Brass ball valve 2-way ball valve actuator unit with pipe thread to EN 10226-1 3-way ball valve actuator unit with drilled L-hole and pipe thread to EN 10226-1 3-way ball valve actuator unit with drilled T-hole and pipe thread to EN 10226-1 Flow is fully opened or closed in both directions 	<ul style="list-style-type: none"> Ball valve actuator unit with double- or single-acting quarter turn actuator DAPS Stainless steel ball valve in compact design NAMUR connection pattern for solenoid valves/limit switch attachments to VDI/VDE 3845 Flow is fully opened or closed in both directions Use in zone 1, 21, 2, 22 	<ul style="list-style-type: none"> Ball valve actuator unit with double- or single-acting quarter turn actuator DAPS Stainless steel ball valve NAMUR connection pattern for solenoid valves/limit switch attachments to VDI/VDE 3845 Flow is fully opened or closed in both directions Use in zone 1, 21, 2, 22 	<ul style="list-style-type: none"> Ball valve actuator unit with double-acting quarter turn actuator DAPS Brass ball valve NAMUR connection pattern for solenoid valves/limit switch attachments to VDI/VDE 3845 Flow is fully opened or closed in both directions
online: →	vzbm	vzbc	vzba	vzpr

Product overview

Software tools

Configurator for butterfly valve units KVZA



Size and order your custom butterfly valve units quickly, easily and reliably via the configurator – without waiting times.

You will receive configuration-specific datasheets and the relevant CAD data or CAD models.

You can find the configurator at

- www.festo.com/process

Process valve units >

Butterfly valve units



Butterfly valve units
KVZA

Description



- For versatile use in various industry sectors
- Manually actuated with hand lever
- Automatically actuated with quarter turn actuator
- Controlled operation with quarter turn actuator and valve positioner
- Butterfly valve type: wafer or lug
- Nominal width DN25 ... DN200
- Connection standard DIN EN 1092-1 or ANSI CLASS 150

online: →

[kvza](#)

Process valves >

Pneumatically actuated media valves

			NEW
	Pneumatic valves VLX	Media separated pneumatic valves VZDB	
Design	Diaphragm valve	Rocker valve with diaphragm seal	
Valve function	2/2-way, closed, monostable	2/2-way, closed, monostable, 3/2-way, monostable, open/closed	
Actuation type	Pneumatic	Pneumatic	
Nominal size	13 ... 25 mm	1.6 mm	
Process valve connection	G1, G1/2, G1/4, G3/4, G3/8	Male thread/male thread	
Flow rate Kv		0.034 m ³ /h	
Standard nominal flow rate	2400 ... 14000 l/min		
Temperature of medium	-10 ... 80°C	0 ... 50°C	
Medium pressure	1 ... 10 bar		
Operating pressure		-0.075 ... 0.1 MPa	
NEW		• New product, 5/2021	
Description	<ul style="list-style-type: none"> • Poppet valve • Indirectly actuated • Brass design • In-line mounting 	<ul style="list-style-type: none"> • Compact width of 10 mm • Very easy to clean thanks to media separation • High-quality materials, therefore also suitable for aggressive media • For dosing, aspirating and for continuous flow applications • Developed according to ISO 13485 	
online: →	vlx	vzdb	

Compressed air preparation



- Service unit combinations and individual units for compressed air preparation in two series: series MS and D (in metal or polymer)
- www.festo.com/pa/airprep

Pneumatic connection technology



- Pipes
 - Tubings
 - Plug connectors
 - Couplings
 - Distributors
 - Protective conduit systems
 - Accessories
- www.festo.com/pa/fittings



Product overview



Product overview



Individual valves >

Media separated valves

	 Media separated solenoid valves VYKA	 Media separated solenoid valves VYKB	 Media separated pneumatic valves VZDB
Size	7	10, 12	10
Valve function	2/2-way, closed, monostable, 2/2 open, single solenoid, 3/2-way, monostable, open/closed	2/2-way, closed, monostable, 3/2-way, monostable, open/closed	2/2-way, closed, monostable, 3/2-way, monostable, open/closed
Operating voltage range DC	12 V, 26 V	12 V, 24 V	
Note on operating voltage range DC	With electrical sub-base VAVE-K1-...		
Coil characteristics	12 - 26 V DC: low-current phase 0.06 W, high-current phase 2.2 W	12 V DC: low-current phase 1 W, high-current phase 3.7 W, 12 V DC: low-current phase 1 W, high-current phase 5.2 W, 24 V DC: low-current phase 1 W, high-current phase 5.2 W, 24 V DC: low-current phase 1 W, high-current phase 3.7 W	
Fluid connection	Flange	Flange	Flange
Nominal size	1.2 mm	1.6 mm, 2 mm	1.6 mm
Flow rate Kv	0.013 m ³ /h, 0.018 m ³ /h, 0.021 m ³ /h	0.034 m ³ /h, 0.056 m ³ /h	0.034 m ³ /h
Medium	Liquid media, Gaseous media	Liquid media, Gaseous media	
Medium pressure [MPa]	-0.05 MPa, 0 MPa, 0.2 MPa	-0.075 MPa, 0.1 MPa, 0.3 MPa	
Materials in contact with the media	FFPM, FPM, PEEK, EPDM	EPDM, FFPM, FPM, PEEK	
Ambient temperature	0 ... 50°C	0 ... 50°C	0 ... 50°C
Description	<ul style="list-style-type: none"> • Compact width of 7 mm • Maximum performance and precision in the smallest of spaces • High flow rate with small size • Very easy to clean thanks to media separation • Low media consumption thanks to small internal volume • FDA-listed materials • High-quality materials, therefore also suitable for aggressive media • High repetition accuracy, switching frequency and precision, therefore also suitable for extremely small volumes and dosing tasks • Very flexible in use thanks to 3/2-way and 2/2-way variants as well as 12 ... 26 V DC control • Optionally with slide-on E-box VAVE-K1 with holding current reduction as accessory • Developed according to ISO 13485 • Sustainable operation thanks to efficient control and active air shut-off 	<ul style="list-style-type: none"> • Compact width of 10 mm or 12 mm • Very easy to clean thanks to media separation • High-quality materials, therefore also suitable for aggressive media • Very flexible in use thanks to 3/2-way or 2/2-way variants as well as 12 or 24 V DC actuation • For dosing, aspirating and for continuous flow applications • Developed according to ISO 13485 • Sustainable operation thanks to efficient control and active air shut-off 	<ul style="list-style-type: none"> • Compact width of 10 mm • Very easy to clean thanks to media separation • High-quality materials, therefore also suitable for aggressive media • For dosing, aspirating and for continuous flow applications • Developed according to ISO 13485
online: →	vyka	vykb	vzdb

Individual valves >

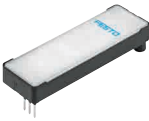



Proportional valves, piezo valves

	 Piezo valves VEMP	 Piezo valves VEAE	 Proportional directional control valves VPWS
Design			Directly actuated poppet valve
Valve function	2/2-way, closed, monostable, 3/3-way, closed, monostable	2/2-way, closed, monostable	2/2 proportional directional control valve, closed
Pneumatic connection 1	Flange	Flange	Cartridge 7.5 mm, Cartridge 15 mm
Actuation type	Electric	Electric	Electric
Operating pressure	0 bar, 0.7 bar, 1.1 bar, 1.7 bar	0 bar, 3 bar, 6 bar	0 bar, 3 bar, 7 bar, 8 bar
Standard nominal flow rate	18 l/min, 19 l/min, 27 l/min, 28 l/min	50 l/min, 53 l/min, 60 l/min, 61 l/min, 64 l/min, 81 l/min	
Standard flow rate pmax -> 0 MPa (0 bar, 0 psi)			46 l/min, 56 l/min, 82 l/min, 98 l/min, 200 l/min, 220 l/min, 270 l/min, 350 l/min
Nominal size	1.3 mm, 1.6 mm	1.2 mm, 1.5 mm, 1.7 mm	1.5 mm, 2.2 mm, 6 mm
Medium	Inert gases, Air, Oxygen (oxygen applications to IEC 60601-1 only on request), Nitrogen	Compressed air as per ISO 8573-1:2010 [5:3:1], Inert gases, Oxygen (oxygen applications to IEC 60601-1 only on request)	Inert gases, Air, Oxygen
Ambient temperature	-20°C, 0°C, 50°C, 70°C	-10°C, 60°C	5°C, 50°C
Description	<ul style="list-style-type: none"> • Very low power consumption • No self-heating • Low leakage • Highly precise • Operating medium: air, oxygen, inert gases, nitrogen • Integrated piezo technology • Long service life • Light weight • Mounting: on sub-base, on manifold rail 	<ul style="list-style-type: none"> • Silent operation • Very low power consumption • No self-heating • Integrated piezo technology • Extremely long service life • Operating medium: air, oxygen, inert gases • Small and lightweight • High throughflow • Mounting via through-holes 	<ul style="list-style-type: none"> • Directly actuated poppet valve • Operating medium: air, oxygen, inert gases • Extremely small and lightweight • Compact and cost-effective • Mounting: on sub-base
online: →	vemp	veae	vpws

Product overview

Individual valves >

Switching valves

	 Solenoid valves VOVK	 Solenoid valves MHA1, MHP1	 Solenoid valves MHE2, MHP2, MHA2, MHE3, MHP3, MHA3, MHE4, MHP4, MHA4	 Fast-switching valves MHJ9, MHJ10
Design	Connection direction downwards, Connection orientation forwards, Poppet valve with spring return	Poppet valve with spring return	Pressure-relieved poppet valve	Poppet valve without spring return
Width	5.9 mm	10 mm, 20 mm	10 mm, 14 mm, 18 mm	9 mm, 10 mm
Valve function	3/2-way, closed, monostable	2/2-way, closed, monostable, 2x2/2-way, monostable, closed, 3/2-way, closed, monostable, 3/2 open, single solenoid	3/2-way, closed, monostable, 3/2 open, single solenoid, 5/2-way, monostable	2/2-way, closed, monostable
Actuation type	Electric	Electric	Electric	Electric
Standard nominal flow rate	5.5 l/min	10 l/min, 14 l/min, 30 l/min	90 l/min, 100 l/min, 200 l/min, 400 l/min	50 l/min, 100 l/min, 160 l/min
Nominal size	0.36 mm	0.65 mm, 0.7 mm, 0.9 mm, 1.5 mm	2 mm, 3 mm, 4 mm	
Operating pressure	-1 bar, 7 bar	-0.9 bar, 0 bar, 1.5 bar, 2 bar, 6 bar, 8 bar	-0.9 bar, 8 bar	0.5 bar, 4 bar, 6 bar, 8 bar
Operating pressure [MPa]	-0.1 MPa, 0.7 MPa		-0.09 MPa, 0.8 MPa	0.05 MPa, 0.4 MPa, 0.6 MPa, 0.8 MPa
Operating medium	Compressed air to ISO 8573-1:2010 [6:4:1]	Compressed air ISO 8573-1:2010 [7:4:4]	Compressed air ISO 8573-1:2010 [7:4:4]	Compressed air ISO 8573-1:2010 [7:4:4]
Nominal operating voltage DC	12 V, 24 V			
Ambient temperature	5°C, 50°C	-5°C, 40°C, 50°C	-5°C, 40°C, 60°C	-5°C, 60°C
Description	<ul style="list-style-type: none"> • Very narrow: 5.9 mm grid dimension • Extremely small and lightweight • Very low power consumption • Variable connection concepts: flanged connection underneath or at the front, barbed fitting connection at the front • Ideal for control of small air flows 	<ul style="list-style-type: none"> • Directly actuated poppet valve • Miniature valve: grid dimension 10 mm • Switching times down to 4 ms • Sub-base valve • Manifold block for 2 ... 10 valves • Use as a pilot valve • UL certification; same connections and cables as for the VUVG 	<ul style="list-style-type: none"> • Directly actuated poppet valve • Fast-switching valve: switching times down to 2 ms • Direct mounting, individual sub-base, manifold assembly • Manifold block for 2 ... 10 valves 	<ul style="list-style-type: none"> • Directly actuated poppet valve • Identical basic valves for direct mounting or manifold installation • Individual valve with integrated plug connection • Switching frequencies up to 1000 Hz • Very good reproducibility • MHJ9: Valve manifold assembly with individual outputs or with air nozzle output • MHJ9: Electrical connection via connecting cable MHJ9-KMH with integrated control electronics • MHJ10: Valve manifold assembly with individual outputs • MHJ10: Electrical connection via moulded-in cable, control electronics included in the valve
online: →	vovk	mh1	mh2	mhj9

Individual valves >

Accessories for individual valves

	 <p>Silencers U</p>	★
Information on silencer insert materials	PE, Bronze	
Pneumatic connection	3/4 NPT, G1, G1/2, G1/4, G1/8, G3/4, G3/8, PK-3, PK-4	
Noise level	70 ... 90 dB(A)	
Ambient temperature	-10 ... 70°C	
Description	<ul style="list-style-type: none"> • Compact design, polymer or die-cast • Barbed fitting or threaded connection • Operating medium compressed air 	
online: →	u	

Individual valves >



Accessories for individual valves

	 <p>Fitting NLFA</p>
Design	Tubing mount via clamped connection, Tubing mount via barbed connector
Design type	Straight design
Fluid connection	UNF1/4-28
Fluid connection 2	For tubing O.D. 3 mm, For tubing I.D. 1.2 mm, For tubing I.D. 2.1 mm, For tubing O.D. 1.6 mm (1/16"), For tubing O.D. 3.2 mm (1/8")
Operating pressure for entire temperature range	-0.75 bar, 4 bar, 6 bar
Operating pressure [MPa] for entire temperature range	-0.075 MPa, 0.4 MPa, 0.6 MPa
Operating pressure [psi] for entire temperature range	-10.875 psi, 58 psi, 87 psi
Medium	Liquid media, Gaseous media
Ambient temperature	0 ... 50°C
Description	<ul style="list-style-type: none"> • For mounting in laboratory devices • Very easy to flush thanks to connection without dead space • For liquid and gaseous media • Also for aggressive liquid media • Materials in contact with the media: PP • For securing tubing and dosing needles • Straight design
online: →	nlfa

Product overview

Individual valves >

Accessories for piezo valves

	 <p>Electronics modules VAVE-P12</p>	 <p>Electronics modules VAVE-P17</p>
Operating voltage range DC	12 ... 24 V	12 ... 24 V
Adjustable output voltage	0 ... 310 V	0 ... 310 V
Voltage of external setpoint input	0 ... 10 V	0 ... 10 V
Max. output current	5 mA	5 mA
Ambient temperature	-10 ... 60°C	-10 ... 60°C
Description	<ul style="list-style-type: none"> • 2-channel open-loop piezo driver • For electrical actuation of the piezo valve VEMP • For electrical actuation of the piezo valves VEMR and VEAE via an adapter of the type NEFV-V13/NEFV-V14 • With protective circuit 	<ul style="list-style-type: none"> • 2-channel open-loop piezo driver • For electrical actuation of the piezo valve VEMC • With protective circuit
online: →	vave	vave



Regulators >

Flow control valves

	 <p>Proportional flow control valves VEMD</p>
Valve function	2-way proportional flow control valve
Operating pressure	0 bar, 2.5 bar
Flow rate control range	0 l/min, 20 l/min
Nominal size	1.4 mm
Nominal operating voltage DC	12 V, 24 V
Reference value	0.2 - 10 V
Medium	Compressed air to ISO 8573-1:2010 [5:4:1], Inert gases, Oxygen (oxygen applications to IEC 60601-1 only on request), Nitrogen
Ambient temperature	0 ... 50°C
Description	<ul style="list-style-type: none"> • Compact module with integrated control electronics • Dynamic regulation with short response time • Mass flow controller (MFC) • Operating medium: air, oxygen, inert gases, nitrogen • Minimal power consumption thanks to piezo technology • Silent: ideal for mobile applications and those close to patients • Direct mounting via thread • Ideal for life sciences applications • Sustainable operation thanks to efficient control
online: →	vemd

Regulators >



Pressure regulators

	 Proportional-pressure regulators VEAA	 Proportional-pressure regulators VEAB	 Proportional pressure regulators VPPE NEW
Valve function	3-way proportional pressure regulator	3-way proportional pressure regulator	3-way proportional pressure regulator, 3-way proportional-pressure regulator, closed
Standard nominal flow rate	7 l/min, 10 l/min, 13 l/min	4.5 l/min, 5 l/min, 13 l/min, 13.5 l/min, 16 l/min, 17 l/min, 20 l/min, 21 l/min	310 l/min, 800 l/min, 850 l/min, 1250 l/min
Operating pressure			8 bar
Inlet pressure 1	0 bar, 11 bar	0 bar, 1 bar, 2 bar, 3 bar, 4 bar, 5.5 bar, 6.5 bar	3 bar, 4 bar, 6 bar, 8 bar, 11 bar
Pressure regulation range			0.02 bar, 0.06 bar, 0.1 bar, 0.15 bar, 2 bar, 6 bar, 10 bar
Operating medium	Inert gases, Compressed air ISO 8573-1:2010 [7:4:4]	Inert gases, Compressed air ISO 8573-1:2010 [7:4:4]	Inert gases, Compressed air ISO 8573-1:2010 [7:4:4]
Nominal operating voltage DC	24 V	24 V	
Reference value	4 - 20 mA, 0 - 5 V, 0 - 10 V	4 - 20 mA, 0 - 5 V, 0 - 10 V	
Ambient temperature	0 ... 50°C	0 ... 50°C	0 ... 60°C
NEW			• New for 12/2021: additional versions
Description	<ul style="list-style-type: none"> • Silent operation • Very low power consumption • Highly precise • Integrated piezo technology • Durable • Mounting: via through-holes, H-rail mounting, on mounting plate or sub-base 	<ul style="list-style-type: none"> • Silent operation • Very low power consumption • Highly precise • Integrated piezo technology • Short switching times • Mounting: using through-holes, H-rail mounting 	<ul style="list-style-type: none"> • Piloted pressure regulator • Setpoint input as analogue voltage signal (0 ... 10 V) • Electrical connection via M12x1 plug, 4 or 5-pin • Available with setpoint module • Variant with display with three retrievable presets and digital controller electronics • For simple control tasks • Variants recommended for production systems for manufacturing lithium-ion batteries
online: →	veaa	veab	vppe

Product overview

Regulators >

Pressure regulators

	 Proportional pressure regulators VPPX	 Proportional-pressure regulators VPPI
Valve function	3-way proportional pressure regulator	3-way proportional pressure regulator
Standard nominal flow rate	1400 l/min, 1650 l/min, 2750 l/min, 7000 l/min	150 l/min, 900 l/min, 1400 l/min, 1630 l/min
Operating pressure		0 bar, 1 bar, 2 bar, 6 bar, 8 bar, 10 bar, 12 bar, 13 bar
Inlet pressure 1	0 bar, 11 bar	0 bar, 6 bar, 13 bar
Pressure regulation range	0.1 bar, 10 bar	-1 bar, 0 bar, 1 bar, 6 bar, 10 bar, 12 bar
Operating medium	Inert gases, Compressed air ISO 8573-1:2010 [7:4:4]	Inert gases, Compressed air ISO 8573-1:2010 [7:4:4]
Nominal operating voltage DC		24 V
Reference value		
Ambient temperature	0 ... 60°C	0 ... 50°C
Description	<ul style="list-style-type: none"> • Pressure regulator with additional sensor input • Programmable, freely adjustable PID controller • Multi-sensor control (cascade control) • Control characteristic adjustable via software FCT (Festo Configuration Tool) • Integrated pressure sensor with separate output • Pressure is maintained if the controller fails 	<ul style="list-style-type: none"> • Select between three predefined and one customer-specific controller preset • With or without display • Low-noise, flexible and highly dynamic • Precise and stable changeover, rapid switching of setpoint by high-performance moving coil actuator • Control via analogue current or voltage signal, digital pattern for adjustable setpoint values or pulse-width modulation signal
online: →	vppx	vppl

Dispense and pipette heads >

Dispense heads



Dispense heads
VTOE

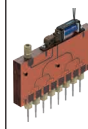

Dispense heads
VTOI

Valve function	2/2-way, closed, monostable	2/2-way, closed, monostable
Operating pressure	0 bar, 0.5 bar	-0.2 bar, 0 bar, 0.65 bar, 1 bar
Internal volume	113 µl valve with fluid connections	10 µl fluid space valve, 178 µl distributor block with valve, needle and fittings
Fluid connection	8x UNF1/4-28, UNF1/4-28	Female thread 1/4-28 UNF-2B
Medium	Liquid media	Liquid media, Gaseous media
Materials in contact with the media	ETFE, FFPM, FPM, PC, PEEK, PPS, High-alloy stainless steel	ETFE, FPM, PEI, PPS, High-alloy stainless steel
Nominal width of dosing needle	0.32 mm, 0.6 mm, 1 mm	0.3 mm
Ambient temperature	5 ... 40°C	5 ... 40°C
Description	<ul style="list-style-type: none"> • Basic function: dosing • Ready-to-install dosing solution saves time and costs • Compact 9 mm grid dimension • Suitable for sensitive and aggressive liquids • Ideally suited to non-contact dispensing of liquid media • Maximum dosing precision down to the microlitre range • Small internal volume makes it easy to rinse • 1- or 8-channel dispense head • Typical coefficient variation (CV): < 1% at 10 to 1000 µl 	<ul style="list-style-type: none"> • Basic function: dosing and aspiration • Highly precise • Compact 9 mm grid dimension • Ideal for microwell plates • 8-channel dispense head • Simple design with side-by-side mounting for increased throughput • High-quality materials, therefore also suitable for aggressive media • The complete dispensing system can be designed with just a few components • A 96-way dispense head can be realised using just 12 valves
online: →	vtoe	vtoi

Product overview

Dispense and pipette heads >

Accessories for dispense heads



Valve control modules
VAEM

Dimensions (W x L x H)	92 mm x 100 mm x 28 mm
Parameterisation	Parameter setting per output
Max. no. of outputs	8
Inrush current, per output	20 ... 1000 mA
Holding current, per output	20 ... 400 mA
Inrush current, total	4 A
Holding current, total	1.8 A
Trigger level	Level 14 V ... 24 V
Time resolution	0.2 ms
Communication interface, protocol	ASCII via RS232
Ethernet interface, protocol	Modbus® TCP
Description	<ul style="list-style-type: none"> • Electronic actuation with integrated, adjustable holding current reduction for controlling up to 8 solenoid valves • Parameterisation, diagnostics and control via graphical user interface (GUI), Ethernet and RS232 interface as well as external 24 V trigger input • Graphical user interface (GUI) for the extremely easy operation and clear visualisation • Very fast valve control with a temporal resolution of 0.2 ms • Easy setting of a calibration factor between the individual channels (opening times per valve)
online: →	vaem

Dispense and pipette heads >

Accessories for dispense heads

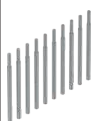

Dosing elements
VAVN

Operating pressure [MPa]	0 ... 0.4 MPa
Flow rate Kv	0.003 ... 0.039 m³/h
Medium	Liquid media, Gaseous media
Materials in contact with the media	High-alloy stainless steel
Ambient temperature	5 ... 60°C
Description	<ul style="list-style-type: none"> • For dosing applications with the highest precision • Length of dosing needle 30 mm or 60 mm • Outside diameter 1.6 mm • Nominal width 0.3 mm, 0.6 mm or 1.2 mm • High corrosion resistance (corrosion resistance class CRC 3 to Festo standard 940 070) and chemical resistance • Design with chamfer and/or with taper • Pack of 10
online: →	vavn

Compressed air preparation



- Service unit combinations and individual units for compressed air preparation in two series: series MS and D (in metal or polymer)
www.festo.com/pa/airprep

Air preparation >

Filter regulators, MS Basic

	 <p>Filter regulators MS2-LFR-B, MS4-LFR-B, MS6-LFR-B</p>	★
Pneumatic connection 1	G1/2, G1/4, M5, QS-6	
Standard nominal flow rate	140 ... 5300 l/min	
Pressure regulation range	0.3 ... 7 bar	
Operating pressure	1 ... 10 bar	
Grade of filtration	5 µm, 40 µm	
Ambient temperature	-5 ... 50°C	
Description	<ul style="list-style-type: none"> • Competitively priced basic component focused on the most important technical functions • Lightweight and sturdy thanks to modern polymer materials • Compatible with the MS series for the ideal combination of low-cost basic functionality and high-end functional requirements • Stable control response • With or without pressure gauge • Rotary knob with latch • With integrated secondary exhausting and primary exhausting with return flow function • MS2: Directly operated diaphragm regulator • MS4, MS6: directly actuated piston regulator • Grid dimension 25, 40, 62 mm (sizes 2, 4, 6) 	
online: →	ms2-lfr	

Product overview



Air preparation >

Pressure regulators, MS Basic

	Pressure regulators MS2-LR-B, MS4-LR-B, MS6-LR-B ★
Pneumatic connection 1	G1/2, G1/4, M5, QS-6
Standard nominal flow rate	170 ... 6000 l/min
Pressure regulation range	0.3 ... 7 bar
Operating pressure	1 ... 10 bar
Ambient temperature	-5 ... 50°C
Description	<ul style="list-style-type: none"> • Competitively priced basic component focused on the most important technical functions • Lightweight and sturdy thanks to modern polymer materials • Compatible with the MS series for the ideal combination of low-cost basic functionality and high-end functional requirements • Stable control response • With or without pressure gauge • Rotary knob with latch • With integrated secondary exhausting and primary exhausting with return flow function • MS2: Directly operated diaphragm regulator • MS4, MS6: directly actuated piston regulator • Grid dimension 25, 40, 62 mm (sizes 2, 4, 6) • Sustainable operation thanks to reduced pressure level
online: →	ms-lr-b

Air preparation >

On/off and soft-start valves, MS Basic

	NEW		NEW
On/off valves MS4-EE, MS6-EE	★	Soft-start valves MS4-EDE, MS6-EDE	★
Pneumatic connection 1	G1/4	G1/2, G1/4	
Standard nominal flow rate	2000 l/min	2000 ... 5000 l/min	
Operating pressure	3 ... 7 bar	3 ... 7 bar	
Actuation type		Electric	
Ambient temperature	-5 ... 50°C	-5 ... 50°C	
NEW	<ul style="list-style-type: none"> • New product, 04/2022 	<ul style="list-style-type: none"> • New product, 04/2022 	
Description	<ul style="list-style-type: none"> • Very compact and extremely lightweight series for use close to the process directly in the machine • Electrically operated 3/2-way valve for pressurising and exhausting pneumatic systems • Ducted exhaust air possible via threaded connection with silencer • Detenting and non-detenting manual override • Supply voltage 24 V DC • With solenoid coil, without plug socket • Grid dimension 40, 62 mm (size 4, 6) 	<ul style="list-style-type: none"> • Very compact and extremely lightweight series for use close to the process directly in the machine • Electrically operated 3/2-way valve for slowly pressurising and exhausting pneumatic systems • The switching pressure can be precisely controlled with a solenoid valve • Adjustable switching time delay • Built-in connections into which the tubing can be directly inserted • Detenting and non-detenting manual override • Supply voltage 24 V DC • With solenoid coil, without plug socket • Grid dimension 40, 62 mm (size 4, 6) 	
online: →	ms-ee-b	ms-ed-b	

Air preparation >

Pressure regulators, individual devices





Precision pressure regulators
LRP, LRPS

Pneumatic connection 1	For sub-base Ø 7 mm, G1/4, G1/8
Standard nominal flow rate	240 ... 2300 l/min
Pressure regulation range	0.05 ... 10 bar
Operating pressure	1 ... 12 bar
Ambient temperature	-10 ... 60°C
Description	<ul style="list-style-type: none"> • Lockable design • Good control characteristics with minimal pressure hysteresis and primary pressure compensation • High secondary exhausting • Variants to EU Explosion Protection Directive (ATEX)
online: →	lrp

Product overview



Sensors >

Pressure and vacuum sensors

	 Pressure transmitters SPTW	 Pressure transmitters SPTE	 Pressure sensors SPAN ★
Pressure measuring range start value	-1 bar, 0 bar	-1 bar, 0 bar	-1 bar, 0 bar
Pressure measuring range start value [MPa]		-0.1 MPa, 0 MPa	-0.1 MPa, 0 MPa
Pressure measuring range end value	1 bar, 2 bar, 6 bar, 10 bar, 16 bar, 25 bar, 50 bar, 100 bar	-1 bar, 1 bar, 10 bar	-1 bar, 1 bar, 10 bar, 16 bar
Pressure measuring range end value [MPa]		-0.1 MPa, 0.1 MPa, 1 MPa	-0.1 MPa, 0.1 MPa, 1 MPa, 1.6 MPa
Switching element function			N/C or N/O contact, switchable
Switching output			2 x PNP or 2 x NPN, switchable, PNP/NPN, switchable
Pneumatic connection	G1/4	Flange, Cartridge 10 mm, Push-in sleeve QS-4, QS-6, QS-3, QS-4	Male thread 1/8 NPT, Female thread G1/8, M5, For tubing O.D. 4 mm, Male thread G1/8, R1/8
Electrical connection		3-wire, Cable, Open end	
Display type			Illuminated LCD
Ambient temperature	0 ... 80°C	0 ... 50°C	0 ... 50°C
Description	<ul style="list-style-type: none"> • Sensor versions: piezoresistive pressure sensor or metal thin-film pressure sensor • Measured variable: relative pressure • Operating medium: liquid media and gaseous media • Seal-free: pressure measuring cell and interfaces in stainless steel • Degree of protection IP67 	<ul style="list-style-type: none"> • Piezoresistive pressure sensor • Measured variable: relative pressure • Cable length 2.5 m • Compact: 8-bracket wall mount for manifold mounting 	<ul style="list-style-type: none"> • For monitoring compressed air and non-corrosive gases • For network monitoring, regulator monitoring, leak testing, object detection • Relative measurement method based on a piezoresistive measuring cell • Serial communication integrated using IO-Link® 1.1 • Compact design 30x30 mm • High-contrast display with blue backlight
online: →	sptw	spte	span

Sensors >





Flow sensors

	 Flow sensors SFAH	 Flow transmitters SFTE
Flow measuring range end value	0.1 l/min, 0.5 l/min, 1 l/min, 5 l/min, 10 l/min, 50 l/min, 100 l/min, 200 l/min	
Operating medium	Argon, Nitrogen, Compressed air ISO 8573-1:2010 [6:4:4]	Nitrogen, Compressed air ISO 8573-1:2010 [6:4:4]
Operating pressure	-0.9 bar, 10 bar	-0.9 bar, 10 bar
Pneumatic connection	Female thread G1/4, G1/8, For tubing O.D. 4 mm, 6 mm, 8 mm	Female thread M5, For push-in connector O.D. 3 mm, 4 mm
Switching output	2 x PNP or 2 x NPN, switchable	
Electrical connection, connection type	Plugs	Cable, Cable with plug
Electrical connection, connection technology	Connection pattern L1, M8x1, A-coded, to EN 61076-2-104	M8x1, A-coded, to EN 61076-2-104, Open end
Ambient temperature	0 ... 50°C	0 ... 50°C
Description	<ul style="list-style-type: none"> • Process air, compressed air, forming gas consumption and pneumatic object monitoring, handling ultra-small parts, leak test • Compact design 20x58 mm • Clear 2-line display • Mounting: H-rail mounting, wall or surface mounting, front panel mounting • Serial communication integrated using IO-Link® 1.1 	<ul style="list-style-type: none"> • Compact design • Universal flow detection • Simple installation • Reliable pick & place application for extremely small workpieces
online: →	sfah	sfte

Product overview





Sensors >

Opto-electrical sensors

	 Colour sensors SOEC	 Retro-reflective sensors, diffuse sensors, distance sensor, light barriers SOOE	 Fork light barriers SOOF	 Fibre-optic cables SOEZ, SOOC
Method of measurement	Colour sensor	Distance sensor	Fork light barrier	Through-beam sensor, Fork light barrier, Light guide, Diffuse sensor
Working range	12 ... 32 mm	0 ... 20000 mm		5 ... 400 mm
Size	50x50x17 mm		Clevis 120x60 mm, 30x35 mm, 50x55 mm, 80x55 mm	M4, M6
Setting options	Teach-in, Teach-in via electrical connection	IO-Link®, Potentiometer, Teach-in	IO-Link®, Potentiometer, Teach-in	
Type of light	White	Laser, Red, LED	Red	
Switching output	PNP	Push-pull	Push-pull, NPN, PNP	
Ambient temperature	-10 ... 55°C	-40 ... 60°C	-25 ... 60°C	-55 ... 160°C
Description	<ul style="list-style-type: none"> • Diffuse sensor • Block design • Electrical connection via M12x1 plug, 8-pin • Display via 7 LEDs 	<ul style="list-style-type: none"> • Simple operation • Fast commissioning • Reliable and stable detection • Attractive price/performance ratio 	<ul style="list-style-type: none"> • Through-beam sensor with minimal installation effort • Design: polymer or metal • Sturdy housing: high shock and vibration resistance • Degree of protection IP67 • Electrical connection via M8x1 plug connector, 3-pin • LED indicators 	<ul style="list-style-type: none"> • Cable connection, push-in connector
online: →	soec	sooe	soof	soez

Sensors >

Opto-electrical sensors

	 Retro-reflective sensors, diffuse sensors, light barriers SOOD	 Sensors SOEG-RT, SOEG-RS	 Through-beam sensors SOEG-E, SOEG-S	 Fibre-optic units SOE4
Method of measurement		Retro-reflective sensor, Diffuse sensor, Diffuse sensor with background suppression	Through-beam sensor, Receiver, Transmitter	Fibre-optic unit
Working range	0 ... 10000 mm	0 ... 2000 mm	20000 mm	
Size		M12, M12x1, M18, M18x1	M18x1	
Setting options		Potentiometer		Teach-in, Teach-in via electrical connection
Type of light	Laser, Red, LED	Red, Red polarised	Red	Red
Switching output	Push-pull	NPN, PNP	NPN, PNP	NPN, PNP
Ambient temperature	-25 ... 60°C	-25 ... 55°C	-25 ... 55°C	-20 ... 60°C
Description	<ul style="list-style-type: none"> • Simple operation • Fast commissioning • Reliable and stable detection • Attractive price/performance ratio 	<ul style="list-style-type: none"> • Round design • Electrical connection via open cable end or plug connector 	<ul style="list-style-type: none"> • Round design • Electrical connection via open cable end or plug connector 	<ul style="list-style-type: none"> • Use for precise and space-saving position sensing in the electronics and light assembly industry • Switching frequencies of up to 8000 Hz • Operational with fibre-optic cable SOOC as accessory • Variants: LED or LED display, timer function • Mounting: H-rail mounting or via through-holes • With protection against mutual interference
online: →	sood	soeg	soeg	soe4

Product overview

Sensors > Image processing systems >

Control units



Controllers
SBRD-Q

Nominal operating voltage DC	24 V
Input/output interface, function	10x digital input, 2x digital inputs with integrated pull-up resistor, 8x digital output, Ground, Power supply
Camera interface, connection technology	USB 3.0 type A
Ethernet interface, protocol	TCP/IP
Ethernet interface, transmission rate	10 Mbit/s, 100 Mbit/s, 1000 Mbps
Storage capacity	32000000000 Byte
Description	<ul style="list-style-type: none"> • Space-saving controller with dual-core processor and PROFINET communication • Two camera interfaces for multi-camera tasks • Up to 256 test programs • Individual image recording and inspection or ongoing image recording and inspection • Detection of the position and the rotary orientation of parts, pick & place, quality inspection, measurement, reading barcodes, data matrix codes and optical characters (OCR) • Powerful image processing software for fast and reliable results
online: →	sbrd

Sensors > Image processing systems >

Camera heads





Camera heads
SBPB

Sensor resolution	1600 x 1200 pixels (UXGA), 2456 x 2054 pixels (5MPix), 1280 x 1024 Pixels (SXGA)
Lens attachment	C mount
Sensor type	Colour, Monochrome
Frame rate (full image)	36, 60
Exposure time	Via mounting kit
Description	<ul style="list-style-type: none"> • High-quality, sturdy housing
online: →	sbpb





Sensors > Image processing systems >

Accessories for image processing systems

			
	Surface lights, ring lights SBAL	Mountings, mounting brackets, swivel mountings SBAM	Protective tubes SBAP
Type of mounting	Clamped in dovetail slot, Via mounting bracket, With accessories	Clamped, With through-hole, Via thread, Via dovetail slot	Via thread
Description	<ul style="list-style-type: none"> External lighting for camera head SBPB 	<ul style="list-style-type: none"> Assembly and mounting attachments for camera head SBPB 	<ul style="list-style-type: none"> To protect the sensor against external influences
online: →	sbal	sbam	sbap

Connection technology >



Standard O.D. tubing

				 ★
	Plastic tubing PFAN	Plastic tubing PTFEN	Plastic tubing PLN	Plastic tubing PUN-H, PUN-H-DUO
Outside diameter	3 ... 12 mm	4 ... 16 mm	4 ... 16 mm	2 ... 16 mm
Inside diameter	2.3 ... 8.4 mm	2.9 ... 11 mm	2.9 ... 12 mm	1.2 ... 11 mm
Temperature-dependent operating pressure	-0.95 ... 16 bar	-0.95 ... 15 bar	-0.95 ... 14 bar	-0.95 ... 10 bar
Ambient temperature	-20 ... 150°C	-20 ... 150°C	-30 ... 80°C	-35 ... 60°C
Description	<ul style="list-style-type: none"> Perfluoroalkoxy alkane Pneumatic tubing with resistance to high temperatures and chemicals Food grade see www.festo.com/certificates/PFAN High resistance to chemicals, microbes, UV radiation, hydrolysis and stress cracks Operating medium: compressed air, vacuum, water 	<ul style="list-style-type: none"> Polytetrafluoroethylene Food grade see www.festo.com/certificates/PTFEN High resistance to chemicals High temperature resistance Operating medium: compressed air, vacuum 	<ul style="list-style-type: none"> Polyethylene High resistance to chemicals, microbes and hydrolysis Food grade see www.festo.com/certificates/PLN Resistant to most cleaning agents and lubricants Operating medium: compressed air, vacuum, water 	<ul style="list-style-type: none"> Polyurethane High resistance to microbes and hydrolysis Food grade see www.festo.com/certificates/PUN_H Suitable for use with energy chains Clean room-compatible combination with fitting NPKA Also available as DUO plastic tubing Operating medium: compressed air, vacuum, water
online: →	pfan	ptfen	pln	pun-h

Product overview



Connection technology >

Fittings

	 Fitting NLFA	 Push-in fittings/connectors, resistant to media NPQP	 Push-in fittings/connectors, standard series QS, QSC, QSF, QSH, QSL, QSS, QST, QSW, QSX, QSY ★
Design	Tubing mount via clamped connection, Tubing mount via barbed connector	Push-pull principle	Push-pull principle
Design type	Straight design		
Fluid connection	UNF1/4-28		
Fluid connection 2	For tubing O.D. 3 mm, For tubing I.D. 1.2 mm, For tubing I.D. 2.1 mm, For tubing O.D. 1.6 mm (1/16"), For tubing O.D. 3.2 mm (1/8")		
Operating pressure for entire temperature range	-0.75 bar, 4 bar, 6 bar		-0.95 bar, 6 bar, 14 bar
Operating pressure [MPa] for entire temperature range	-0.075 MPa, 0.4 MPa, 0.6 MPa		
Operating pressure [psi] for entire temperature range	-10.875 psi, 58 psi, 87 psi		
Medium	Liquid media, Gaseous media		
Materials in contact with the media	PP		
Ambient temperature	0 ... 50°C	-20 ... 60°C	-20 ... 80°C
Description	<ul style="list-style-type: none"> • For mounting in laboratory devices • Very easy to flush thanks to connection without dead space • For liquid and gaseous media • Also for aggressive liquid media • Materials in contact with the media: PP • For securing tubing and dosing needles • Straight design 	<ul style="list-style-type: none"> • Polypropylene • Low-cost alternative to stainless steel: resistant to most cleaning agents in combination with tubing PLN • For use with extreme media influences • Food grade see www.festo.com/certificates/NPQP • Operating medium: compressed air, vacuum 	<ul style="list-style-type: none"> • Standard series • Wide range of variants: wide selection for maximum flexibility in standard applications • PBT and nickel-plated brass • Operating media: compressed air, vacuum, (water)
online: →	nlfa	npqp	qs

Connection technology >



Fittings

	 Push-in fittings/connectors NPQR	 Threaded fittings NPFC
Design	Push-pull principle	
Design type		
Fluid connection		
Fluid connection 2		
Operating pressure for entire temperature range	-0.95 bar, 12 bar, 16 bar	
Operating pressure [MPa] for entire temperature range	-0.095 MPa, 1.2 MPa, 1.6 MPa	
Operating pressure [psi] for entire temperature range	-13.775 psi, 174 psi, 232 psi	
Medium		
Materials in contact with the media		
Ambient temperature	-20 ... 150°C	-20 ... 150°C
NEW	<ul style="list-style-type: none"> New for 02/2022: additional versions 	
Description	<ul style="list-style-type: none"> Very easy to clean thanks to chamfered O-ring and fewer edges where dirt can accumulate Optimal price/performance ratio, perfect for applications from a single source Maximum corrosion resistance (corrosion resistance class CRC 4 to Festo standard 940 070) and chemical resistance High temperature resistance Stainless steel Operating media: compressed air, vacuum, (water) 	<ul style="list-style-type: none"> Brass, nickel-plated Sleeve Extension Double nipple Reducing nipple L-, T-, Y- or X-fitting Operating medium: compressed air, vacuum
online: →	npqr	npfc

Product overview



Drives >

Piston rod cylinders

	 Round cylinders EG-PK	 Cartridge cylinders EGZ
Mode of operation	Single-acting, Pushing	Single-acting, Pushing
Piston diameter	2.5 mm, 4 mm, 6 mm	6 mm, 10 mm, 16 mm
Theoretical force at 0.6 MPa (6 bar, 87 psi), advancing	1.9 ... 11.8 N	13.9 ... 109 N
Stroke	5 ... 25 mm	5 ... 15 mm
Cushioning	On one side, Not adjustable, No cushioning	No cushioning
Description	<ul style="list-style-type: none"> • Micro cylinder • Barbed fitting for plastic tubing with standard I.D. • Without position sensing 	<ul style="list-style-type: none"> • Minimal installation space • Installation with or without mounting components • Piston rod with male thread
online: →	eg-pk	egz

Drives >

Electric actuators

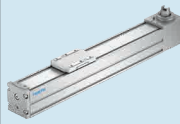
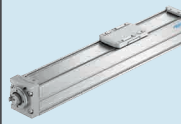
	 Toothed belt axes EGC-TB-KF ★	 Spindle axes EGC-BS-KF ★	 Toothed belt axes ELGC-TB-KF ★ NEW	 Spindle axes ELGC-BS-KF ★ NEW
Design	Electromechanical linear axis, With toothed belt	Electromechanical linear axis, With ball screw	Electromechanical linear axis, With toothed belt	Electromechanical linear axis, With ball screw
Size	50, 70, 80, 120, 185	70, 80, 120, 185	45, 60, 80	32, 45, 60, 80
Working stroke	50 ... 8500 mm	50 ... 3000 mm	200 ... 2000 mm	100 ... 1000 mm
Max. acceleration	50 m/s ²	15 m/s ²	15 m/s ²	15 m/s ²
Max. speed	3 ... 5 m/s	0.5 ... 2 m/s	1.2 ... 1.5 m/s	0.6 ... 1 m/s
Max. feed force F _x	50 ... 2500 N	400 ... 3000 N	75 ... 250 N	40 ... 350 N
Max. force F _y	50 ... 2500 N	400 ... 3000 N	75 ... 250 N	40 ... 350 N
Max. force F _z	650 ... 15200 N	1850 ... 15200 N	600 ... 2700 N	300 ... 2700 N
Motor type	Stepper motor, Servo motor	Stepper motor, Servo motor	Stepper motor, Servo motor	Stepper motor, Servo motor
Ambient temperature	-10 ... 60°C	-10 ... 60°C	0 ... 50°C	0 ... 50°C
NEW			<ul style="list-style-type: none"> • New for 12/2021: additional versions 	<ul style="list-style-type: none"> • New for 12/2021: additional versions
Description	<ul style="list-style-type: none"> • Axis for high speeds and acceleration • Recirculating ball bearing guide for high loads and torques • Optionally with clamping unit, at one or both ends • Profile with optimised rigidity • 22 types in stock with short delivery times and modular products for custom variants 	<ul style="list-style-type: none"> • Axis for high repeat accuracy • Recirculating ball bearing guide for high loads and torques • Optionally with clamping unit, at one or both ends • Profile with optimised rigidity • Various spindle pitches • The optional spindle support enables maximum travel speed • Axial or parallel motor mounting 	<ul style="list-style-type: none"> • Precision guide rail with high load capacity • Internal guide and toothed belt • Flexible motor mounting • The toothed belt axes, spindle axes ELGC and mini slides EGSC form a scalable modular system for compact automation • Variants recommended for production systems for manufacturing lithium-ion batteries 	<ul style="list-style-type: none"> • Internal guide and ball screw drive • Space-saving position sensing • Flexible motor mounting • The toothed belt axes, spindle axes ELGC and mini slides EGSC form a scalable modular system for compact automation • Variants recommended for production systems for manufacturing lithium-ion batteries
online: →	egc	egc	elgc-tb	elgc-bs

Drives >



Electric actuators

	 Electric slides EGSK	 Mini slides EGSL-BS	 Mini slides EGSC-BS-KF
Design	Electromechanical linear axis, With ball screw drive	Electric mini slide, Guidance, With ball screw drive	Electric mini slide, With ball screw drive
Size	15, 20, 26, 33, 46	35, 45, 55, 75	25, 32, 45, 60
Working stroke	25 ... 840 mm	50 ... 300 mm	25 ... 200 mm
Max. acceleration	10 m/s ² , 20 m/s ²	25 m/s ²	5 m/s ² , 15 m/s ²
Max. speed	0.16 ... 1.48 m/s	0.3 ... 1.3 m/s	0.133 ... 0.6 m/s
Max. feed force Fx	19 ... 392 N	75 ... 450 N	20 ... 250 N
Max. force Fy	19 ... 392 N	75 ... 450 N	20 ... 250 N
Max. force Fz	764 ... 4919 N	291 ... 1539 N	669 ... 4937 N
Motor type		Stepper motor, Servo motor	Stepper motor, Servo motor
Ambient temperature	0 ... 40°C	0 ... 60°C	0 ... 50°C
NEW			• New for 12/2021: additional versions
Description	<ul style="list-style-type: none"> • Electromechanical linear axis with ball screw drive • Recirculating ball bearing guide and ball screw without caged ball bearings • Standardised mounting interfaces • Compact design • High rigidity • 22 types in stock with short delivery times and modular products for custom variants 	<ul style="list-style-type: none"> • Very high rated slide load, ideal for vertical applications such as press-fitting or joining • Reliable: the completely closed spindle stops dirt or stray small parts getting into the guide area • Axial or parallel motor mounting 	<ul style="list-style-type: none"> • Precise guide and ball screw drive • Compact dimensions • Flexible motor mounting • The toothed belt axes, spindle axes ELGC and mini slides EGSC form a scalable modular system for compact automation • Variants recommended for production systems for manufacturing lithium-ion batteries
online: →	egsk	egsl	egsc-bs

Product overview

Drives >

Handling systems

	 <p>Two-dimensional planar surface gantries EXCM</p>	 <p>Rotary gripper modules EHMD</p>
Design	Planar surface gantry	Electric rotary drive, Electric gripper, Pneumatic gripper
Size	30, 40	40
Stroke per gripper jaw		5 mm, 15 mm
Max. output torque		0.3 Nm
Gripping force per gripper jaw		3 ... 35 N
Rotation angle		Infinite
Motor type	Stepper motor	Stepper motor
Nominal voltage DC		24 V
Ambient temperature	10 ... 50°C	0 ... 40°C
Description	<ul style="list-style-type: none"> • Excellent functionality in small installation spaces • Low moving dead weight • Actuation via two stepper motors with an integrated optical encoder and a two-axis controller • With recirculating ball bearing guide • Sustainable operation due to weight-optimised axes 	<ul style="list-style-type: none"> • Ideal for small objects in laboratory automation • Infinite electrical rotation and electrical or pneumatic gripping • Gripping and turning to open and close covers on vials • Optional: mounting with Z-compensation compensates for the thread pitch of covers on vials during opening and closing
online: →	excm	ehmd

Drives >

Motors and servo drives > Stepper motors

	 <p>Stepper motors EMMS-ST</p>	★
Nominal motor current	1.4 ... 9.5 A	
Max. rotational speed	430 ... 6000 rpm	
Motor holding torque	0.09 ... 9.3 Nm	
Ambient temperature	-10 ... 50°C	
Description	<ul style="list-style-type: none"> • Small increments and high driving torques thanks to 2-phase hybrid technology • Optimised connection technology • Four sizes with flange sizes 28, 42, 57 and 87 • 28 types in stock • With incremental encoder for closed-loop operation • Degree of protection IP40 (motor shaft), IP54 (sizes 42, 27, 87: motor housing and plug connection), IP65 (size 28: motor housing and plug connection) • Optionally with holding brake 	
online: →	emms	

Drives >

Motors and servo drives > Electronic controllers

	
Controllers CECC-D, CECC-LK, CECC-S	
Operating voltage	19.2 - 30 V DC V DC, 20.4 - 30 V DC V DC
CPU data	400 MHz processor
Fieldbus interface	
Ambient temperature	0 ... 55°C
Description	<ul style="list-style-type: none"> • Compact programmable logic controller • Programming with CoDeSys to IEC 61131-3 • 12 digital inputs, 8 digital outputs, additionally 2 high-speed counters up to 250 kHz • Ethernet 10/100 Mbit/s • USB interface for data transfer • CECC-LK with CANopen, IO-Link®, I-Port and Modbus TCP protocol
online: →	cecc

Drives >

Motors and servo drives > Stepper motor controllers

	
Servo drives CMMT-ST	
Nominal current load supply	8 A
Nominal voltage, load supply DC	24 V, 48 V
Fieldbus coupling	EtherCAT, Modbus/TCP, EtherNet/IP, PROFINET
Safety information	
Performance level (PL)	STO/Cat. 3, PLd (EC motor without diagnostics), STO/Cat. 3, PLe (stepper motor/EC motor with diagnostics)
Ambient temperature	0 ... 50°C
Description	<ul style="list-style-type: none"> • Very efficient for tasks with low power requirements • Ideal for positioning tasks and point-to-point and interpolating motion solutions • 50% more compact than the smallest servo drive CMMT-AS • 150 W at 24 V DC, 300 W at 48 V DC • With safety functions • Optimised for use with stepper motors like the tried-and-tested EMMS-ST
online: →	cmmt-st



Product overview

Grippers, rotary drives >

Electric grippers



Parallel grippers, electric
EHPS

Design	Worm gear unit, T-shape, Rack and pinion, Electric gripper
Size	16, 20, 25
Stroke per gripper jaw	10 ... 16 mm
Max. force on gripper jaw F _z , static	200 ... 450 N
Gripper repetition accuracy	≤0.03 mm
Motor type	DC servo motor
Electrical connection	5-pin, Cable with plug, M12x1
Nominal operating voltage DC	24 V
Protocol	IO-Link®
Ambient temperature	5 ... 60°C
Description	<ul style="list-style-type: none"> • Electric version of the pneumatically actuated parallel gripper DHPS • Ideal for use as a front-end actuator thanks to its low dead weight • Controller-free actuation using digital signals • Gripping force (4 settings) adjustable via ratchet switch or via IO-Link® interface • RA1 version with robot connection, enables fast integration in lightweight robot environments
online: →	ehps

Grippers, rotary drives >

Accessories for grippers



Gripper jaw
DHAS-GG



Gripper jaw mountings
EHAA-G1

Size	16 mm	16
Type of mounting	With female thread M3	
Ambient temperature	0 ... 40°C	0 ... 40°C
Description	<ul style="list-style-type: none"> • Process-reliable gripping, e.g. for microtiter plates in the life sciences sector • Easy assembly 	<ul style="list-style-type: none"> • Gripper fingers for horizontal or vertical mounting on the gripper jaws • Stainless steel design
online: →	dhas	ehaa-g1

Grippers, rotary drives >

Electric semi-rotary drives

Rotary drives
ERMO

Size	12, 16, 25, 32
Max. driving torque	0.15 ... 5 Nm
Max. rotational speed	100 ... 200 rpm
Rotation angle	Infinite
Description	<ul style="list-style-type: none"> • Electric rotary drive with stepper motor and integrated gear unit • ServoLite – closed-loop operation with encoder • Heavy-duty bearing for high forces and torques • Backlash-free, pre-stressed rotating plate with very good axial eccentricity and concentricity properties • Quick and accurate installation • For simple rotary indexing table applications and as a rotary axis in multi-axis applications
online: →	ermo

Grippers, rotary drives >

Handling systems

Rotary gripper modules
EHMD

Design	Electric rotary drive, Electric gripper, Pneumatic gripper
Size	40
Stroke per gripper jaw	5 mm, 15 mm
Max. output torque	0.3 Nm
Gripping force per gripper jaw	3 ... 35 N
Rotation angle	Infinite
Motor type	Stepper motor
Nominal voltage DC	24 V
Ambient temperature	0 ... 40°C
Description	<ul style="list-style-type: none"> • Ideal for small objects in laboratory automation • Infinite electrical rotation and electrical or pneumatic gripping • Gripping and turning to open and close covers on vials • Optional: mounting with Z-compensation compensates for the thread pitch of covers on vials during opening and closing
online: →	ehmd

Product overview

Electronic controllers >

Electronic controllers



Controllers
CECC-D, CECC-LK, CECC-S

Operating voltage	19.2 - 30 V DC V DC, 20.4 - 30 V DC V DC
CPU data	400 MHz processor
Fieldbus interface	
Ambient temperature	0 ... 55°C
Description	<ul style="list-style-type: none"> • Compact programmable logic controller • Programming with CoDeSys to IEC 61131-3 • 12 digital inputs, 8 digital outputs, additionally 2 high-speed counters up to 250 kHz • Ethernet 10/100 Mbit/s • USB interface for data transfer • CECC-LK with CANopen, IO-Link®, I-Port and Modbus TCP protocol
online: →	cecc

Services >

Energy Saving Services



Compressed Air Energy Efficiency Audit
GFAA

Description	<ul style="list-style-type: none"> • TÜV-certified energy efficiency analysis of the entire compressed air system according to DIN EN ISO 11011 • Available in three packages, depending on the number of existing compressors • Analysis of the current situation with weighted recommendations for improving energy efficiency • Documentation of CO2 values, costs and savings potentials • Savings of up to 60% of the compressed air costs of pneumatic systems • Improved productivity and Overall Equipment Effectiveness (OEE) • Sustainable operation by checking the energy efficiency of the compressed air system
online: →	gfaa





Product overview



Technical support

	
Technical support	
Description	<ul style="list-style-type: none"> • Support in the event of equipment downtime or malfunction • Identifying the cause of the error • Deriving technical solutions • Error elimination • Remote support/on-site support
online: →	www.festo.com/support



Commissioning services

					
Installation service		On-site commissioning service for axis systems		Remote commissioning service for axis systems	
Description	<ul style="list-style-type: none"> • Mechanical installation • Pneumatic installation • Electric installation • Available for products and system solutions from Festo 	<ul style="list-style-type: none"> • Inspecting the cabling, electrical and pneumatic connections as well as travel distances and energy chains • Configuring and parameterising, incl. optimising the controller parameters and homing • Activating components in test mode • Data backup and documentation • Instruction manual for operators • Available for 1, 2 and 3-axis systems with and without safety module • Service is performed on site 	<ul style="list-style-type: none"> • Checking electrical connections and of the travel paths • Configuration and parameterisation • System test • Data backup and documentation • Introduction to the Festo Automation Suite software • Available for 1, 2 and 3-axis systems with and without safety module • Service is provided via remote communication 		
online: →	www.festo.com/service	www.festo.com/catalogue/gfch	www.festo.com/catalogue/gfch		



Commissioning services

			
Commissioning service servo press kit GFCY2-A5, GFCY2-A5-R		PLC integration service servo press kit GFCY2-A2, GFCY2-A2-R	
Description	<ul style="list-style-type: none"> • Support with commissioning • Support with the electrical installation • Checking the electrical connections and the travel path • Configuration and parameterisation • Testing the system, data backup and documentation • Introduction to WebVisu software • Remote service/on-site service 	<ul style="list-style-type: none"> • On-site support for the integration of function blocks into the higher-level control system (based on an empty project) • Testing the communication between the YJKP servo press kit and the higher-order controller • Functional test of the relevant function blocks for controlling the servo press kit YJKP based on a sample project • Introduction to the structure of the function blocks and their functionality • Remote service/on-site service 	
online: →	www.festo.com/catalogue/gfca	www.festo.com/catalogue/gfca	

Maintenance and repair services



	 <p>Maintenance service</p>	 <p>Repair service</p>
Description	<ul style="list-style-type: none"> • Checking for signs of damage and wear • Checking mechanical, pneumatic, and electrical connections and connectors • Checking the air preparation • Carrying out component-specific inspections • Lubricating/re-lubricating guides • Tightening connectors • Replacing air filters • Replacing silencers • Carrying out component-specific preventive maintenance tasks • Troubleshooting • Solution finding/error elimination • Eliminating leakages • Replacing or servicing components 	<ul style="list-style-type: none"> • In-house repair components from Festo • Analysis of economic efficiency • Inspection • Cleaning • Replacement of worn-out parts • Function test
online: →	www.festo.com/service	www.festo.com/service

Energy Saving Services



	 <p>Pre-audit energy efficiency air system</p>	 <p>Compressed air energy efficiency audit</p>	 <p>Analysing compressed air generation</p>
Description	<ul style="list-style-type: none"> • Inspecting/analysing the compressor station: consumption, flow rate, pressure, capacity utilisation • Analysing the air preparation: design and type of dryer • Analysing the design of the compressed air network: pressure measurement at two points and calculating the pressure drop • Random check of air consumption: leakage detection and energy efficiency analysis of the system • Air quality measurement: water and oil content • Estimating the air savings potential • Recommendations for increasing the energy efficiency of the air system • Executing and documenting the results in compliance with DIN ISO 11011 • Implementing and documenting the results in the “Festo Energy Saving Services Portal” in accordance with DIN ISO 11011 	<ul style="list-style-type: none"> • TÜV-certified energy efficiency analysis of the entire compressed air system according to DIN EN ISO 11011 • Available in three packages, depending on the number of existing compressors • Analysis of the current situation with weighted recommendations for improving energy efficiency • Documentation of CO2 values, costs and savings potentials • Savings of up to 60% of the compressed air costs of pneumatic systems • Improved productivity and Overall Equipment Effectiveness (OEE) • Implementing and documenting the results in the “Festo Energy Saving Services Portal” in accordance with DIN ISO 11011 	<ul style="list-style-type: none"> • Measuring the installed compressors • Current consumption • Delivery rate • Pressure band • Analysing the compressor output • Analysing the usage ratio (workload) • Calculating the leakages • Calculating the annual electricity and compressed air costs as well as potential savings by eliminating leakages • Implementing and documenting the results in the “Festo Energy Saving Services Portal” in accordance with DIN ISO 11011
online: →	www.festo.com/energysaving	www.festo.com/catalogue/gfaa	www.festo.com/energysaving

Product overview

Energy Saving-Services

	 Air quality analysis	 Compressed air consumption analysis	 Leakage detection and documentation
Description	<ul style="list-style-type: none"> Inspecting the decentralised air preparation Measuring the residual oil content (up to ISO 8573-1:2010 class 2) Measuring the pressure dew point (up to ISO 8573-1:2010 class 2) Analysing the measurement results Suggested improvements Implementing and documenting the results in the "Festo Energy Saving Services Portal" in accordance with DIN ISO 11011 	<ul style="list-style-type: none"> Installing and removing measuring devices with standard parts (fittings, tubing, etc.) Measuring the static compressed air consumption of machines at standstill and in operation Calculating losses due to leakages Determining the consumption per machine cycle Determining the average consumption per minute Determining the max./min. pressure Determining the average pressure level Determining the max./min. air flow Analysing the measurement results Implementing and documenting the results in the "Festo Energy Saving Services Portal" in accordance with DIN ISO 11011 	<ul style="list-style-type: none"> Localising leakages with ultrasonic detectors in the entire compressed air system during operation Classifying the leakages according to size and cost Gathering relevant information for eliminating the leakage: photo documentation, recommended measures, required spare parts, estimated repair time, prioritising measures, assessing whether maintenance can be carried out during machine operation, indicating optimisation options Results available online on the Festo Energy Saving Assessment Portal Implementing and documenting the results in the "Festo Energy Saving Services Portal" in accordance with DIN ISO 11011
online: →	www.festo.com/energysaving	www.festo.com/energysaving	www.festo.com/energysaving

Energy Saving-Services

	 Leakage elimination	 Machine analysis for energy efficiency
Description	<ul style="list-style-type: none"> Comprehensive elimination of leakages Repairing or replacing the affected components based on the report of the leakage detection Final verification using leakage test Implementing and documenting the results in the "Festo Energy Saving Services Portal" in accordance with DIN ISO 11011 	<ul style="list-style-type: none"> Measuring compressed air consumption of machines/systems Carrying out a leakage detection Identifying the energy saving potential by assessing the energy efficiency of the system design Proposing solutions for improving energy consumption including the calculation of possible annual savings potential Calculating the amortisation time Implementing and documenting the results in the "Festo Energy Saving Services Portal" in accordance with DIN ISO 11011
online: →	www.festo.com/energysaving	www.festo.com/energysaving

System optimisation



System optimisation

Description

- Developing customer-specific solutions for the modernisation and optimisation of equipment and/or applications
- Calculating, selecting and sizing products incl. CAD drawings and circuit diagrams
- Simulating and testing in order to optimise the existing system/application
- Implementing optimisation measures
- Documentation

online: →

www.festo.com/service

Service contract



Service contract

Description

- Customer-specific service contract with a range of service options
- Regular inspections according to recommendations by Festo
- Regular preventive maintenance
- Software updates
- Replacing worn or defective components
- Guaranteed availability
- Guaranteed reaction times for on-site support in the event of machine downtime or malfunctions

online: →

www.festo.com/service

Training programs and courses



Energy Saving Services workshop

Description

- Basic principles of “energy efficiency in pneumatic systems”
- Carrying out leakage detection using ultrasonic detection equipment
- Documenting leakages
- Theory and practical exercises

online: →

www.festo.com/service

Product overview



Sales and service network – International

Argentina

Festo S.A.
Edison 2392
1640 Buenos Aires
P +54 810 555 33786
F +54 810 444 3127
ventas.ar@festo.com

Australia

Festo Pty. Ltd. Head Office
Browns Road 179-187
Noble Park
3174 Melbourne
P +61 397 9595-55
F +61 397 9597-87
info_au@festo.com

Austria

Festo Gesellschaft m.b.H.
Linzer Straße 227
1140 Vienna
P +43 1 910 75-100
F +43 1 910 75-250
automation.at@festo.com

Belarus

IUP Festo
Masherov avenue 78
Office 201
220035 Minsk
P +375 17 204 85 58
F +375 17 204 85 59
info_by@festo.com

Belgium

Festo Belgium nv
Leuvensesteenweg 248J
Everest Office park
1800 Vilvoorde
P +32 2 702 32 11
F +32 2 702 32 09
info_be@festo.com

Brazil

Festo Brasil Ltda
Rua Guiseppe Crespi 76
Jd. Santa Emília
04183-080 São Paulo
P +55 11 5013 1600
F +55 11 5013 1801
linhadireta.br@festo.com

Bulgaria

Festo EOOD
Bul. Christopher Kolumb 9
1592 Sofia
P +359 2 960 07 12
F +359 2 960 07 13
festo_bg@festo.com

Canada

Festo Inc.
Explorer Drive 5300
L4W 5G4 Mississauga
P +1 905 614 4600
F +1 877 393 3786
info_ca@festo.com

Chile

Festo S.A.
Av. Américo Vespucio 2680
9020000 Santiago de Chile
P +56 2 2690 2801
F +56 2 2690 2860
info.cl@festo.com

China

Festo (China) Ltd.
Yunqiao Road, No.1156
201206 Shanghai
P +86 21-60815100
F +86 21 58540300
sales.cn@festo.com

China

Festo Ltd.
Castle Peak Road, No. 497
6/F New Timely Factory
Building, Kowloon, HK
999077 HongKong
P +852 3904 20 91
F +852 2745 91 43
sales_hk@festo.com

Colombia

Festo S.A.S.
Autopista Medellín Km 6.3
Costado Sur
250208 Tenjo, Cundinamarca
P +57 60 1 865 77 88
F +57 1 865 7729
ventas.co@festo.com

Croatia

Festo d.o.o.
Nova Cesta 181 A
10000 Zagreb
P +385 1 619 1969
F +385 1 619 1818
info_hr@festo.com

Czech Republic

Festo, s.r.o.
Modřanská 543/76
14700 Prague
P +420 261 09 96 11
F +420 241 77 33 84
info_cz@festo.com

Denmark

Festo A/S
Islevdalvej 180
2610 Rødovre
P +45 70 21 10 90
F +45 70 21 10 99
sales_dk@festo.com

Estonia

Festo OY AB Eesti Filiaal
Karjavalja 10
12918 Tallinn
P +372 666 1560
info.ee@festo.com

Finland

Festo Oy
Mäkituvantie 9
01511 Vantaa
P +358 9 87 06 51
F +358 9 87 06 52 00
info.fi@festo.com

France

Festo E.U.R.L.
Rue du Clos Sainte-Catherine 8
ZA des Maisons Rouges
94360 Bry-sur-Marne
P +33 1 48 82 64 00
F +33 1 48 82 64 01
info_fr@festo.com

Germany

Festo Vertrieb GmbH & Co. KG
Festo Campus 1
73734 Esslingen
P +49 711 347-1111
F +49 711 347-2244

Hungary

Festo Kft.
Csillaghegyi út 32-34
1037 Budapest
P +36 1 436 51 11
F +36 1 436 51 01
info_hu@festo.com

India

Festo India Private Limited
237B, Hosur Road,
Bommasandra Industrial Area
560099 Bengaluru
P +91 (0) 1800 425 0036 / 1800 121
0036
sales.in@festo.com

Indonesia

PT. Festo
Jl. Tekno V Blok A/1 Sektor XI, Kawasan
Industri BSD, Banten
15314 Serpong Tangerang
P +62 804 1 2 33786
F +62 804 1 4 33786
sales_id@festo.com

Iran

Festo Pneumatic S.K.
Special Karaj Road
6th street, 16th avenue, # 2
1389793761 Teheran
P +98 21 44 52 24 09
F +98 21 44 52 24 08
info@festo.ir

Ireland

Festo Limited
Sandyford Park Unit 5
D18VH99 Dublin
P +353 (0)1 295 49 55
sales_ie@festo.com

Israel

Festo Pneumatic Israel Ltd.
Hakadar st. 3
7178633 Modi'in
P +972(8)6246666
F +972(8)6246677
info_il@festo.com

Sales and service network – International

Italy

Festo SpA
Via Enrico Fermi 36/38
20057 Assago
P +39 02 45 78 81, +39 02 45794
350
F +39 02 488 06 20, +39 02 4884
2012
info_it@festo.com, contatti@festo.
com

Japan

Festo K.K.
Hayabuchi 1-26-10
224-0025 Yokohama
P +81 45 593 56 10
F +81 45 593 56 78
info.jp@festo.com

Jordan

Festo DMCC
Zahar St. 13
11953 Amman
P +962-6-5563646
F +962-6-5563736
info_mena@festo.com

Kazakhstan

Festo Branch Kazakhstan
Ul. Karmysova 92
050010 Almaty
P +7 727 233 08 32
F +7 727 233 07 89
info@festo.kz

Korea

Festo Korea Co., Ltd.
Mullae-ro 28-gil 25
Young City N Tower 12F
07298 Seoul
P +82-1666 0202
saleskr@festo.com

Latvia

Festo SIA
Gunāra Astras 8b
1082 Riga
P +371 67 57 78 64
F +371 67 57 79 46
info_lv@festo.com

Lithuania

Festo, UAB
V. Krevės pr. 129
50312 Kaunas
P +370 37 3213 14
F +370 37 32 13 15
info.lt@festo.com

Malaysia

Festo Sdn Bhd
Jalan Teknologi 14A
Taman Sains Selangor 1, Kota Daman-
sara, Selangor
47810 Petaling Jaya
P +60 3 6144 1122
F +60 3 6141 6122
csc_my@festo.com

Mexico

Festo Pneumatic, S.A.
Av. Ceylán 3
Col. Tequesquínahuac, Tlalnepantla
54020 Estado de México
P 800 337 8669
ventas.mexico@festo.com

Netherlands

Festo B.V.
Schieweg 62
2627 AN Delft
P +31 15 251 88 90
F +31 15 251 88 67
sales.nl@festo.com

New Zealand

Festo Ltd.
Fisher Crescent 20
Mt. Wellington
1062 Auckland
P +64 9 574 10 94
F +64 9 574 10 99
info_nz@festo.com

Nigeria

Festo Automation Ltd.
Badejo Kalesanwo Street 6
C. Woermann Building, Matori Indus-
trial Estate
100253 Lagos
P +234 2930812
F +234 2930813
enquiry.ng@festo.com

Norway

Festo AS
Ole Devik's vei 2
0666 Oslo
P +47 22 72 89 50
F +47 22 72 89 51
sales_no@festo.com

Peru

Festo S.R.L.
Av. Circunvalación del Golf Los Incas
134
Torre II Oficina 401
01 Lima
P +51 1 219 69 60
F +51 1 219 69 71
ventas.pe@festo.com

Philippines

Festo Inc.
West Service Road KM18
South Superhighway
1700 Paranaque City, Metro Manila
P +63 1800 10 12 33786
F +65 1800 10 14 33786
festoph@festo.com

Poland

Festo Sp. z o.o.
ul. Mszczonowska 7
05-090 Raszyn
P +48 22 711 41 00
F +48 22 711 41 02
info_pl@festo.com

Portugal

Festo – Automação, Unipessoal, Lda.
Rua Manuel Pinto De Azevedo 567
Apartado 8013
4109601 Porto
P +351 22 615 6150
F +351 22 615 6189
info.pt@festo.com

Romania

Festo S.R.L.
Strada Sfântul Constantin 17
010217 Bucharest
P +40 21 403 95 00
F +40 21 310 24 09
festoro@festo.com

Russia

000 Festo-RF
Michurinskiy prosp. 49
119607 Moscow
P +7 495 737 34 00
F +7 495 737 34 01
info.ru@festo.com

Serbia

Festo Srbija
Omladinskih brigada 90v
(poslovni centar Airport City)
11070 Belgrade
P +381 (011) 7853 900
F +381 (011) 7853 911
info@festo.rs

Singapore

Festo Pte. Ltd.
Kian Teck Way 6
628754 Singapore
P +65 6285 8585 (Sales) / +65 6415
6700 (General)
F +65 6415 6900
sales.sg@festo.com

Slovakia

Festo spol. s r.o.
Gavlovičová ul. 1
83103 Bratislava
P +421 2 49 10 49 10
F +421 2 49 10 49 11
info_sk@festo.com

Slovenia

Festo d.o.o.
Blatnica 8
1236 Trzin
P +386 1 530 2100
F +386 1 530 2125
info_si@festo.com

South Africa

Festo (Pty) Ltd.
Electron Avenue, Isando 18-26
P.O. Box 255
1600 Johannesburg
P +27 11 971-5500
F +27 11 974-2157
sales.za@festo.com

Sales and service network – International

Spain

Festo Automation, S.A.U.
 Avinguda de la Granvia 159
 Hospitalet de Llobregat
 08908 Barcelona
 P +34 901243660
 F +34 902243660
info_es@festo.com

Sweden

Festo AB
 Stillmansgatan 1
 212 25 Malmö
 P +46 40 38 38 00
 F +46 40 38 38 10
sales_se@festo.com

Switzerland

Festo AG
 Gass 10
 5242 Lupfig
 P +41 44 744 5544
 F +41 44 744 5500
info.ch@festo.com

Taiwan

Festo Co., Ltd.
 Gong 8th Road, No.9
 Gong 2nd Industrial Park, Linkou Dist.
 244010 New Taipei City
 P +886 2 2601-9281
 F +886 2 2601-9286
info_tw@festo.com

Thailand

Festo Ltd.
 Kanchanapisek Road 202
 Ramintra, Khannayao
 10230 Bangkok
 P +66 1 800 019 051 / +66 0 2092 3700
 F +66 1 800 019 052
sales_th@festo.com

Turkey

Festo San. ve Tic. A.S.
 Universite Cad. 45
 Tuzla
 34953 Istanbul
 P +90 444 1 378
 F +90 216 585 00 50
info_tr@festo.com

Ukraine

DP Festo
 Borysohlibska 11
 04070 Kiev
 P +380 44 233 6451
 F +380 44 463 7096
orders_ua@festo.com

United Arab Emirates

Festo DMCC
 Swiss Tower, unit 505
 Cluster Y, JLT
 Dubai
 P +962 6 5563646
 F +962 6 5563736
info_mena@festo.com

United Kingdom

Festo Limited
 Caswell Road 55
 Applied Automation Centre
 NN4 7PY Northampton
 P +44 800 626 422
info.gb@festo.com

United States

Festo Corporation / Didactic Inc.
 Columbia Road 7777
 45039 Mason
 P +1 (513) 486-1050
sales-support.didactic.us@festo.com
/services.didactic@festo.com

Venezuela

Festo C.A.
 Av. 23 esquina con calle 71
 N° 22-62, Edif. Festo, Sector Paraíso
 4001 Maracaibo
 P +58 261 759 1120
 F +58 261 759 1417
info_ve@festo.com

Vietnam

Festo Company Limited
 Floor 2, HQ Tower, No. 9, Tran Nao
 Street, Quarter 3 An Khanh Ward, Thu
 Duc City
 700000 Ho Chi Minh City
 P +84 28 3514 5600
 F +84 28 3514 5601
sales_vn@festo.com

What must be taken into account when using Festo products?

The limit values specified in the technical data and any specific safety instructions must be adhered to by the user in order to ensure correct functioning.

The pneumatic components must be supplied with correctly prepared compressed air free of aggressive media.

Take the ambient conditions at the place of use into consideration. Corrosive, abrasive and dusty environments (e.g. water, ozone, grinding dust) will reduce the service life of the product.

Check the resistance of the materials of Festo products to the media used and surrounding media.

When Festo products are used in safety-oriented applications, all national and international laws and regulations, for example the EC Machinery Directive, together with the relevant references to standards, trade association rules and the applicable international regulations must be observed and complied with.

Unauthorised conversions or modifications to products and systems from Festo constitute a safety risk and are thus not permitted.

Festo does not accept any liability for the resulting damages.

You should contact Festo if one of the following applies to your application:

- The ambient conditions and conditions of use or the operating medium differ from the specified technical data.
- The product is to perform a safety function.
- A risk or safety analysis is required.
- You are unsure about the product's suitability for use in the planned application.
- You are unsure about the product's suitability for use in safety-oriented applications.

All technical data are correct at the time of going to print.

All content, texts, representations, illustrations and drawings included in this catalogue are the intellectual property of Festo SE & Co. KG and are protected by copyright law.

No part of this publication may be reproduced, processed, translated or transmitted in any form or by any means, electronic, mechanical, photocopying or otherwise, without the prior written permission of Festo SE & Co. KG.

All technical data is subject to change according to technical updates.

ABB® is a registered trademark of ABB Asea Brown Boveri Ltd. in certain countries.

Allen-Bradley® is a registered trademark of Rockwell Automation, Inc. in certain countries.

ANSI® is a registered trademark of the American National Standards Institute, Incorporated in certain countries.

AS-Interface® is a registered trademark of Verein zur Förderung busfähiger Interfaces für binäre Aktuatoren und Sensoren e. V. in certain countries.

ASME® is a registered trademark of the American Society of Mechanical Engineers in certain countries.

Beckhoff® is a registered trademark of Hans Beckhoff in certain countries.

Cage Clamp® is a registered trademark of WAGO Kontakttechnik GmbH & Co. KG in certain countries.

CANopen® is a registered trademark of CAN in AUTOMATION - International Users and Manufacturers Group e.V. in certain countries.

CC-LINK® is a registered trademark of Mitsubishi Electric Corporation in certain countries.

CiROS® is a registered trademark of Dortmunder Initiative zur rechnerintegrierten Fertigung (RIF) e.V. in certain countries.

CODESYS® is a registered trademark of 3S-Smart Software Solutions GmbH in some countries.

DeviceNet® is a registered trademark of ODVA, Inc. in certain countries.

EasyIP® is a registered trademark of Novagraaf Nederland B.V. in certain countries.

ECOLAB® is a registered trademark of Ecolab USA, Inc. in certain countries.

EHEDG European Hygienic Engineering & Design Group® is a registered trademark of Stichting Ehedg in certain countries.

EnDat® is a registered trademark of Dr. Johannes Heidenhain GmbH in certain countries.

ePLAN electric P8® and ePLAN fluid® are registered trademarks of EPLAN Software & Service GmbH & Co. KG in certain countries.

EtherCAT® is a registered trademark of Beckhoff Automation GmbH in certain countries.

Ethernet POWERLINK® is a registered trademark of ABB ASEA BROWN BOVERI LTD COMPANY in certain countries.

EtherNet/IP® is a registered trademark of ODVA, Inc. in certain countries.

Excel® is a registered trademark of Microsoft Corporation in certain countries.

Fin Ray® is a registered trademark of EvoLogics GmbH in certain countries.

HACCP - Hazard Analysis Critical Control Points® is a registered trademark of Rizzo Graziana in certain countries.

HARAX® is a registered trademark of HARTING Electric GmbH & Co. KG in certain countries.

HIPERFACE® is a registered trademark of Sick Stegmann GmbH in certain countries.

International Electrotechnical Commission® is a registered trademark of the International Electrotechnical Commission in certain countries.

INTERBUS® is a registered trademark of Phoenix Contact GmbH & Co. KG in certain countries.

IO-Link® is a registered trademark of Profibus Nutzerorganisation e.V. in certain countries.

JohnsonDiversey® is a registered trademark of S.C. Johnson & Son, Inc. in certain countries.

Loctite® is a registered trademark of Henkel IP & Holding GmbH in certain countries.

Makrolon® is a registered trademark of Covestro Deutschland AG in certain countries.

Microsoft® is a registered trademark of Microsoft Corporation in certain countries.

MITSUBISHI® is a registered trademark of Mitsubishi Corporation in certain countries.

Modbus® is a registered trademark of Schneider Electric USA, Inc. in certain countries.

NAMUR® is a registered trademark of NAMUR - Interessengemeinschaft Automatisierungstechnik der Prozessindustrie e.V. in certain countries.

ODVA® is a registered trademark of ODVA, Inc. in certain countries.

OPC UA® is a registered trademark of the OPC Foundation in certain countries.

PROFIsafe® is a registered trademark of Siemens Aktiengesellschaft in certain countries.

Rockwell Automation® is a registered trademark of Rockwell Automation, Inc. in certain countries.

SERCOS interface® is a registered trademark of SERCOS International e.V. in certain countries.

SIMATIC® is a registered trademark of Siemens Aktiengesellschaft in certain countries.

SucoNet® is a registered trademark of Eaton Electrical IP GmbH & Co. KG in certain countries.

Systainer® is a registered trademark of TTS Tooltechnic Systems AG & Co. KG in certain countries.

Teflon® is a registered trademark of The Chemours Company FC in certain countries.

TORX® is a registered trademark of Acument Intellectual Properties, LLC in certain countries.

TwinCAT® is a registered trademark of Beckhoff Automation GmbH in certain countries.

UL® is a registered trademark of Underwriters Laboratories Inc. in certain countries.

VDMA® is a registered trademark of Verband Deutscher Maschinen- und Anlagenbau (VDMA) e.V. in certain countries.

Viton® is a registered trademark of The Chemours Company FC in certain countries.

Vulkollan® is a registered trademark of Covestro Deutschland AG in certain countries.

Windows® is a registered trademark of Microsoft Corporation in certain countries.

The above-mentioned trademarks are registered/applied-for trademarks of the respective trademark holder in certain countries. All other trademarks not listed here are the property of their respective owners in some countries.